

A Publication of the
National Wildfire
Coordinating Group

Sponsored by
United States
Department of Agriculture

United States
Department of the Interior

National Association of
State Foresters

Wildland Fire Suppression Tactics Reference Guide



PMS 465

APRIL 1996

NFES 1256



PREFACE

The Wildland Fire Suppression Tactics Reference Guide is designed to supplement courses that teach tactics in the Wildland Fire Qualification System. It can be used by the beginning firefighter to learn basic tactics as well as a review of fire suppression tactics for the advanced firefighter.

This reference guide was developed under the direction of the National Wildfire Coordinating Group Training Working Team with coordination and assistance of Fire Managers from the following agencies:

United States Department of the Interior

Bureau of Land Management
National Park Service
Bureau of Indian Affairs

United States Department of Agriculture

Forest Service

National Association of State Foresters

Colorado State Forest Service
Minnesota Division of Forestry

We appreciate the efforts those people associated with the design and development of this product.

Additional copies of this publication may be ordered from:

**National Interagency Fire Center
ATTN: Supply
3833 S. Development Ave.
Boise, Idaho 83705**

Order NFES #1256

CONTENTS

INTRODUCTION TO REFERENCE GUIDE	1
FIRE ORDERS	2
WATCH OUT SITUATIONS	3
LOOKOUTS. COMMUNICATIONS. ESCAPE ROUTES. SAFETY ZONES (LCES)	4
SECTION 1 FIRE SUPPRESSION PRINCIPLES	5
Fire Sizeup and Initial Attack.....	7
How to Attack a Fire.....	15
Where to Attack a Fire.....	18
Fireline Location	20
Fireline Flagging	26
Fireline Construction	29
Coyote Tactic	36
Crew Production Rates.....	38
Fireline Explosives	41
Mopup.....	44
Minimum Impact Suppression Tactics (MIST)	48
SECTION 2 USE OF WATER AND ADDITIVES	57
Types of Pumps.....	59
Hydraulics	62
Series, Parallel, and Staged Pumping	71
Hose Lays	75
Mopup	78
Tactical Use of Water	79
Surfactants	92
Class A Foam	93
Retardants	101
Firegels	101

SECTION 3 . USE OF FIRE IN CONTROL OPERATIONS	103
Burning Out and Backfiring	105
Types of Fire Spread	109
Ignition Techniques	113
Strip Firing.....	113
One, Two, Three - Three, Two, One (1-2-3/3-2-1) Firing Concept	115
Head and Strip Head Firing	117
Blowhole Firing	118
Spot Firing.....	119
Ring Firing	120
Chevron Firing	121
Burn Strip	122
Planning and Conducting Firing Operations.....	123
Special Firing Considerations	124
Firing Equipment.....	127

SECTION 4. MECHANICAL EQUIPMENT.....	131
Dozers	133
Comparison of Dozers Used For Fireline Construction.....	134
Dozer Production Rates	140
Dozer Line Construction Principles.....	144
Tractor Plows	148
Principles of Tractor Plow Operations	149
Engines	153
Mobile Attack.....	156
Tandem Tactic.....	157
Pincer Tactic	158
Envelopment Tactic	159
Stationary Attack	160
Inside-out Tactic	161
Parallel Attack.....	162
Engine Production Rates	164

SECTION 5. TACTICAL AIR OPERATIONS	165
Factors Affecting Aircraft Use	167
Factors to Consider in Retardant Aircraft Use	170
Types, Effects, and Use of Retardant	173
Recommended Retardant Coverage Levels	175
Retardant Evaluation Criteria	176
Air Tanker Tactics	177
Principles of Retardant Application	180
SECTION 6. WILDLAND URBAN INTERFACE	181
Kinds of Wildland/Urban Interface	183
Structural Fire Behavior	184
Wildland Urban Fire Sizeup Considerations	185
Structure Triage	188
Wildland/Urban Interface Firefighting Tactics	191
Structure Full Containment.....	194
Structure Partial Containment	195
Structure No Containment	196
Structural Firefighting Situations That Shout "Watch Out".....	200
Structural Watch Out Situations & Triage Made Easier to Remember..	201
SECTION 7 . FUELS, FIRE BEHAVIOR, AND TACTICS BY GEOGRAPHIC	
AREAS OF THE UNITED STATES	203
Alaska	205
Northwest and Northern Rocky Mountains	219
Southern and Central California	237
Great Basin and Southern Rocky Mountains	257
Southwest	283
Northeast	297
Southeast	313
GLOSSARY OF TERMS	333

INTRODUCTION

The Wildland Fire Suppression Tactics Reference Guide provides basic tactical information on suppressing wildland fires. It also provides information on wildland fire fuels, fire behavior, and tactics by geographic areas of the United States.

It can be used by the beginning firefighter to learn more about tactics or determining exactly where and how to build a control line and what other suppression measures are necessary to extinguish a fire.

It can be used as a review of fire suppression tactics for the advanced firefighter.

The tactics reference guide is intended to be a supplement, but not a substitute for wildland fire training. It does not qualify a person for any wildland firefighting position.

This guide does not include nor address the constraints on firefighting imposed by environmental laws and regulations; i.e., designated wilderness areas, wilderness study areas, threatened and endangered species, cultural and archeology sites, air quality, etc.

FIRE ORDERS

Fight fire aggressively but provide for safety first.

Initiate all action based on current and expected fire behavior.

Recognize current weather conditions and obtain forecasts.

Ensure instructions are given and understood.

Obtain current information on fire status.

Remain in communication with crew members, your supervisor and adjoining forces.

Determine safety zones and escape routes.

Establish lookouts in potentially hazardous situations.

Retain control at all times.

Stay alert, keep calm, think clearly, act decisively.

WATCH OUT SITUATIONS

(Survival Checklist)

Fire not scouted and sized up.

In country not seen by daylight.

Safety zones and escape routes not identified.

Unfamiliar with weather and local factors influencing fire behavior.

Uninformed on strategy, tactics and hazards.

Instructions and assignments not clear.

No communication link with crew members/supervisor.

Constructing fireline without safe anchor point.

Building fireline downhill with fire below.

Attempting frontal attack on the fire.

Unburned fuel between you and the fire.

Cannot see main fire, not in contact with anyone who can.

On a hillside where rolling material can ignite fuel below.

Weather is getting hotter and drier.

Wind increases and/or changes direction.

Getting frequent spot fires across line.

Terrain and fuels make escape to safety zones difficult.

Taking a nap near the fireline.

LOOKOUTS, COMMUNICATIONS, ESCAPE ROUTES, SAFETY ZONES (LCES)

Figure 1 displays the concept of LCES which is posting lookout(s) if you cannot see the fire, maintaining communications between the lookout(s) and firefighters, and always knowing your escape route(s) and safety zone(s). If LCES is constantly practiced the Standard Firefighting Orders and Watch Out Situations will not be compromised.

Figure 1 – LCES

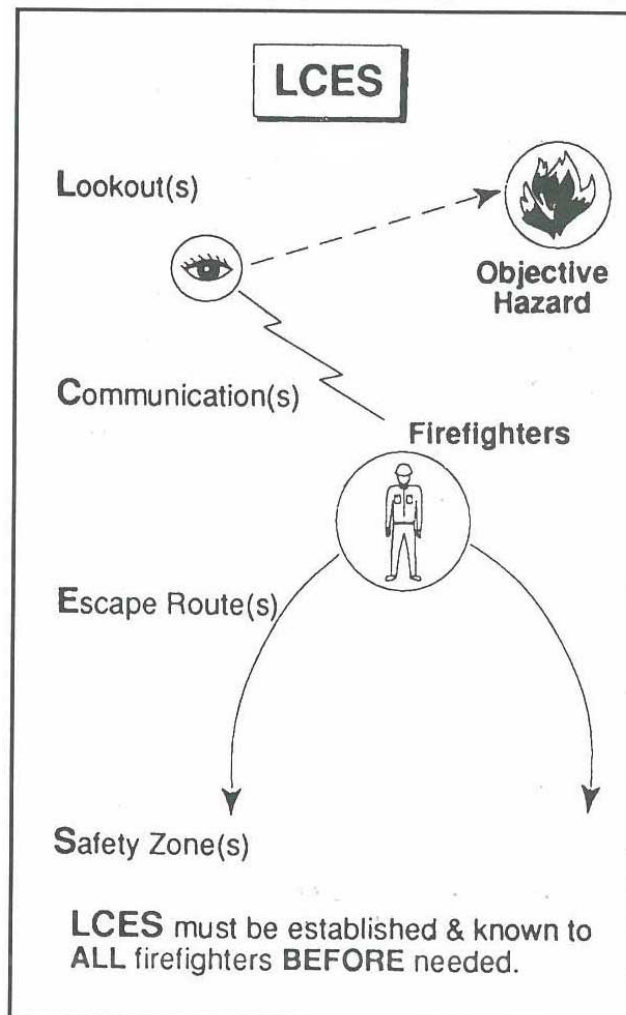

SECTION 1 - FIRE SUPPRESSION PRINCIPLES

Strategy is an overall plan of action for fighting a fire which gives regard to the most cost efficient use of personnel and equipment in consideration of resource values threatened, fire behavior, legal constraints, and objectives established for resource management.

Tactics are the operational aspects of fire suppression. Determining exactly where and how to build a control line and what other suppression measures are necessary to extinguish a fire. Tactics must be consistent with the strategy established for suppressing a fire.

The purpose of this section on fire suppression principles is to acquaint all firefighters with the factors to size up a fire and apply the strategy and tactics that will enable an appropriate suppression response to be completed in a safe, efficient manner, and facilitate rehabilitation of the suppression impacts.

Most wildland fires are suppressed by initial attack (first to arrive) forces. Some wildland fires become large for various reasons. Fire suppression principles apply to initial attack as well as to large fires or parts of large fires.

FIRE SIZEUP AND INITIAL ATTACK

Often times firefighters and incident commanders take shortcuts concerning fire sizeup, establishing communications and safety. A thorough fire sizeup, establishing communications among all resources on a fire, and applying safety to all aspects of fire suppression are critical elements that must be adhered to. If adequate communications can not be established and firefighter safety is compromised then it is time to back off and re-evaluate your tactics.

If you are assigned to fight fire in an area where you are unfamiliar with the local fuels, weather, topography, and fire behavior you should request a briefing from the local agency, to provide you with this information.

In many cases sizeup and initial attack go hand in hand because the firefighter with a passion for safety begins to gather information about the fire situation from the initial dispatch and/or prior to departing to the fire incident.

En route To a Fire

En route to a fire begin to think about your knowledge of the fire area and how current conditions compare to past experiences. Some items to consider are:

- Firefighter safety.
- Fuels and terrain. What are the fuels? Are they heavy timber types or light, flashy, grass types? Are the fuels sheltered from direct solar radiation due to aspect or cover? Is the terrain steep or gentle? How do you expect this fire to burn compared to recent fires in similar areas?
- Weather-is the windspeed greater or less than the forecast? Is it from the same direction? Are there dust devils or gusty winds that would indicate erratic behavior? Is the humidity about what was forecast? Are there any indicator clouds or thunderstorms?
- Smoke column-check size, height, color, direction and shape.

The greater the height and size of the column the greater the fire intensity. A fractured (bent over by the wind) column indicates a wind-driven fire. Wind-driven fires can pose serious threats to safety as the fire grows. Spotting can become long range creating new fires ahead of the main fire. However, direction and rate of spread is more predictable.

A large developing mushroom shaped column can indicate a plume-dominated fire where the fire's rate of spread and direction is very unpredictable. Strong wind indrafts and downbursts can occur with short range spotting in all directions.

Light colored smoke generally indicates lighter burning fuels whereas a dark colored smoke indicates heavier burning fuels such as brush or timber.

- Access routes and their limitations-also look for alternate routes.
- Fire barriers (natural and human made).
- Potential water sources.
- Land ownership (including cooperative agreements and assistance on fire suppression).
- History of fires in area and cause.
- Capabilities of responding resources and available back-up forces.
- Look for people coming from the fire area or suspicious people at the fire scene. Write down license plate numbers and descriptions of vehicles and/or people.
- Public safety concerns.

Arrival On Fire Scene

Safety of assigned resources, facilities, and the public should always be a prime item to consider when evaluating possible attack options. An appropriate decision **always** provides for safety first. The Fire Orders, Watch Out Situations, and the LCES system are to be implemented and reviewed often.

After arrival on the fire scene, your next decisions are critical to initial attack success. This is where you "make it or break it." If you go off in all directions little will be accomplished and firefighter safety could be jeopardized. You need to gather additional **critical** information to **complete** the fire sizeup and formulate an appropriate plan of attack.

These are the key factors you should observe in relation to fuels, weather, topography, and fire behavior during your sizeup process:

Fuels:

- Type/model.
- Size classes present and size classes burning.
- Are fuels light and continuous?
- Live/dead ratio (frost, bug kill, drought conditions).
- Fine dead fuel moisture (dangerous below 6%).
- Live fuel moisture (chaparral, sagebrush, Gambel oak, etc.)
- Vertical arrangement and horizontal continuity (ladder fuels, tight crown spacing less than 20 feet).
- Loading (heavy vs. light).
- Snag concentrations.
- Areas with reburn potential.
- Access restrictions for personnel.

Some fuels such as chamise, chaparral, pines, palmetto-gallberry, junipers, mountain laurel, rhododendron, and eucalyptus burn hotter and produce longer flame lengths than others because they contain flammable oils.

Generally, taller and thicker fuel will produce longer flame lengths and control lines must be wider.

Heavy fuels do not ignite easily and fires do not spread as fast as in light fuels such as grass, leaves, needles, and twigs. However, once ignited, logs, snags, and heavy branches burn for a long time and may require wide control lines to keep the flame, sparks, or radiated heat from igniting fuels across the line.

Fuel moisture and whether fuel is dead or alive have a definite effect on a burning fire's intensity. Generally, the drier the fuel the hotter it burns and longer flame lengths are produced. Longer flame lengths require wider firelines to stop the fire.

Topography:

- Aspect.
- Position on slope (ridge top, mid-slope, drainage bottom).
- Building line downhill or uphill.
- Width of canyons (wide/narrow).
- Box canyons and/or chutes.
- Percent slope.
- Potential for rolling material.
- Available natural and/or constructed barriers.
- Elevation.

When a fireline is built above a fire burning on a slope, generally the steeper the slope, the wider the line must be because the fire usually burns faster and more intensely than on a gentler slope. The more gentle the slope the narrower the line can be.

When a fireline is built below a fire burning on a slope, the width of the line does not depend so much on the slope, but trenching becomes important. Generally the steeper the slope, the deeper the trench must be, to prevent rolling burning material from crossing the fireline.

Weather:

- Maximum/minimum relative humidities.
- Wind velocity, direction and patterns (gusty vs. steady).
- Temperature variations.
- Thermal belts.
- Thunderstorm activity.
- Diurnal wind patterns and windspeed.

- Inversions.
- Foehn winds.
- Battling winds or sudden calm.

When a gravity or foehn wind interacts with a local wind, significant wind reversals are likely. Definite indicators are winds baffling back and forth causing a wavering smoke column and a sudden calm.

A decreasing foehn wind that allows a local wind to regain influence can be as dangerous as the foehn wind that overpowers a local wind. A wind reversal from a decreasing foehn wind has been a factor in several fatality fires.

- Weather forecasts (request spot weather forecast if predicted weather condition is unknown).
- Last precipitation and amounts.
- Indicators of turbulence (dust devils, thunderstorms, lee sides of ridges, saddles).
- Indicators of instability (clear visibility, smoke rising straight up, inversions lifting).
- Indicator clouds.
- Haines Index 5 or 6.

In general the higher the temperature and the lower the humidity, the lower the fuel moisture. The lower the fuel moisture, the more intensely a fire will burn and the wider the fireline must be.

The wind or air currents increase the burning intensity by supplying more oxygen, by moving currents of hot, drying air into the fuels ahead, or by actually carrying burning embers (spotting) ahead of the fire itself. Therefore, the 'stronger the wind or convection current, the wider the line must be.

Fire Behavior:

- Rate of spread on various portions of the fire.
- Flame lengths on various portions of the fire.
- Type of fire spread (smoldering, creeping, running, torching, spotting).
- Classification of fire (ground, surface, aerial [trees torching]).
- Indicators of extreme fire behavior (a rapid buildup of intensity, a high sustained rate of spread, a well developed convection column, frequent or long distance spotting [600 feet or more], firewhirls, horizontal flame sheets)
- Size of fire.
- Location of fire in relation to topographic features (chutes, canyon bottoms, ridge tops, mid-slope).

Flame length is an important fire behavior factor you should be concerned with during sizeup. Generally fires with flame lengths greater than 4 feet are too intense for direct attack on the head by persons using hand tools (see Figure 2).

Figure 2 – Fire Suppression Limitations Based On Flame Length*

Flame Length	
4'	Fires can generally be attacked at the head or flanks by persons using hand tools. Handline should hold the fire.
4'-8'	Fires are too intense for direct attack on the head by persons using hand tools. Handline cannot be relied on to hold fire.
8'-11'	Fires may present serious control problems; torching out, crowning and spotting. Control efforts at the head will probably be ineffective.
>11'	Crowning, spotting and major fire runs are probable. Control efforts at the head of the fire are ineffective.

*This may be modified for local fuels and conditions.

Other critical elements to consider:

- Restrictions on suppression tactics (wilderness areas, threatened and endangered species, etc.).
- Span of control.
- Biological and environmental hazards.
- Constructed hazards (powerlines, hazardous waste dump sites).
- Urban interface.
- Availability of critical support (hose lays, helicopter/fixed wing).
- Physical and mental condition of assigned resources.
- Ability to re-supply.
- Availability of human made and natural barriers (game trails, cow paths, roads, trails, lakes, rivers, old burns).
- Availability of water sources.
- Observation points.
- Archeological sites.
- Cultural resource sites.
- Accessibility and mobility.
- Poor visibility.
- Coordination with dispatch and/or adjoining forces.
- Other agency involvement.

Now that you have sized up the fire the following decisions need to be made:

- How to establish and implement lookouts, communications, escape routes, and safety zones (LCES).
- How to attack the fire (direct, parallel, indirect attack).
- Where to anchor and attack the fire (rear, flanks, head).
- Organization and command structure.
- Location of control line.
- Type of control line (width, burnout).
- Additional help needed.

Considering the following factors will help make the decisions above.

- Firefighter safety.
- Size of fire and fire behavior.
- Fire environment (fuels, weather--current and predicted, topography).
- Forces presently available to construct control line and hold it.
- Location of the fire head.
- Period of day fire is burning into (morning, afternoon, night).
- Improvements and other values in path of fire.
- Point of origin and cause.
- Public safety.

HOW TO ATTACK A FIRE

If you are the first person to arrive at a fire or a single resource boss in charge of the first crew at a fire, you have several problems. You are confronted with deciding; 1) what is the most important work to do first, and 2) where the most effective work can be done. Keep in mind at all times that firefighter safety is the highest priority in fire suppression.

After sizing up the fire you need to select an anchor point and make your attack. Following are some good practices in making an initial attack or suppressing a large fire.

- If you are the incident commander, establish an organization and command structure. Make sure your subordinates know the plan and are kept informed on changing conditions, tactics and/or strategies.
- Use water or dirt to cool and extinguish hot spots.
- Anticipate future control action when the fire cannot be contained promptly.
- Construct fireline uphill from an anchor point.
- As a first effort, keep fire out of the most dangerous fuels, and prevent it from becoming established in explosive types of fuels, such as grass, thickets of tree seedlings, heavy brush, or slash areas.
- Confine fire as quickly as possible.
- Locate and build firelines. Move all rollable material so it cannot roll across firelines.
- Leave no significant areas of unburned material close to fireline.
- To gain control, swiftly locate and build fireline in the easiest and safest places for line construction that can be held. Burn out as needed when line is constructed and burning out can be controlled.
- Utilize existing barriers to full extent.
- If fire spread cannot be contained, notify dispatch and do some safe, effective work on at least a part of the fire.
- Where improvements (houses, other buildings, fences) are involved, consider all the facts before determining which point to attack first. No improvement or piece of property is worth firefighter injury or fatality.

Now a decision must be made concerning how to attack a fire. The methods of attack are direct, parallel, and indirect.

Direct attack is made directly on the fire's edge or perimeter (see Figure 3). The flames may be knocked down by dirt or water and the fire edge is generally treated by a follow-up fireline. Or, a fireline is constructed close to the fire's edge and the fuel between the fireline and the fire is burned out or the fire is allowed to burn to the fireline.

Figure 3 – Direct Attack



Direct attack generally works best on fires burning in light fuels or fuels with high moisture content burning under light wind conditions. Direct attack works well on low intensity fires (flame lengths less than 4 feet) which enable firefighters to work close to the fire.

A major advantage of direct attack is firefighter safety. Firefighters can usually escape back into the burned area for a safety zone. This is known as "keeping one foot in the black."

Parallel attack is made by constructing a fireline parallel to, but further from, the fire edge than in direct attack (see Figure 4). This tactic may shorten fireline construction by cutting across unburned fingers. In most cases the fuel between the fireline and the fire edge is burned out in conjunction with fireline construction.

Figure 4 – Parallel Attack

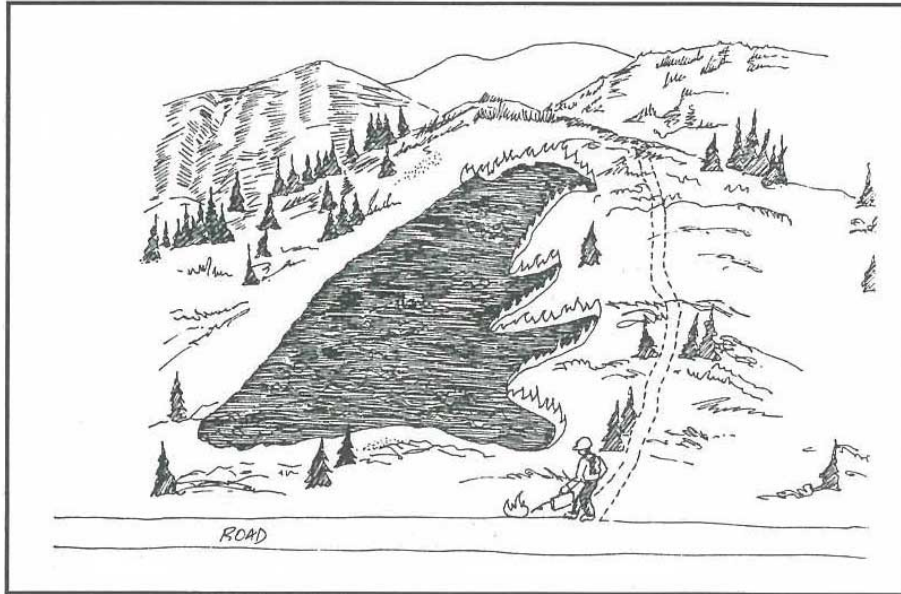

Indirect attack is accomplished by building a fireline some distance from the fire edge and backfiring the unburned fuel between the fireline and the fire edge (see Figure 5). Indirect attack takes advantage of using natural and human-made barriers as fireline and allows a choice of timing for backfiring. Indirect attack is generally used on hot fires with high rates of spread where direct attack is not possible.

Figure 5 – Indirect Attack

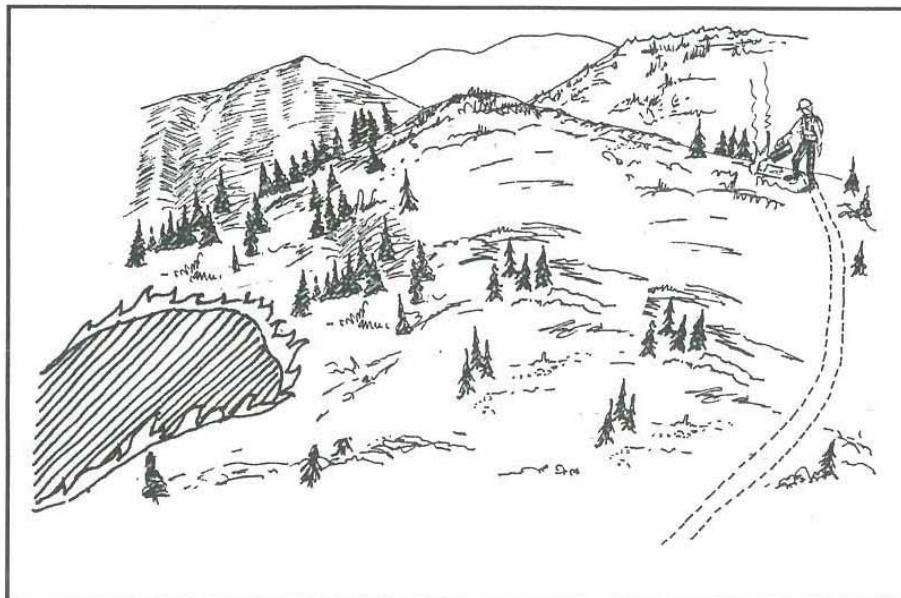

WHERE TO ATTACK A FIRE

The parts of the fire to be controlled are the head, the flanks, and the rear (see Figure 6).

Figure 6 – Parts Of A Fire

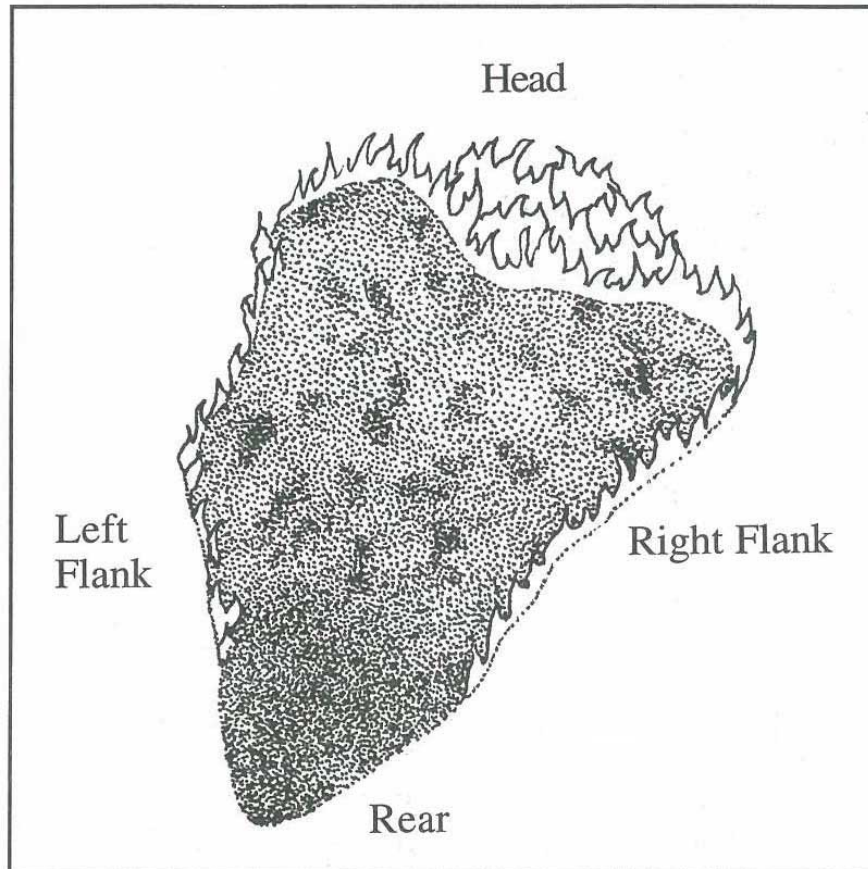

Fires are generally attacked where they are most likely to escape and this may require attacking the fire at the head, flanks, rear, or any combination of the three. However, your primary concern is attacking the fire where it can be done safely. A good practice is to always pick an anchor point to start fighting the fire and to prevent the fire from outflanking you.

Fireline intensity (flame length) and rate of spread generally determine which part of the fire to attack in both initial attack and suppressing large fires. Figure 2-Fire Suppression Limitations Based On Flame Length, page 12, provides guidance to make decisions on which part of the fire to attack and whether to make a direct, parallel, or indirect attack.

A technique to attack a fire where it is most likely to escape or stop hotter burning portions of a fire is called hotspotting (see Figure 7).

Figure 7 – Hotspotting, Using Temporary Lines
To Check Fire Spread And Gain Time

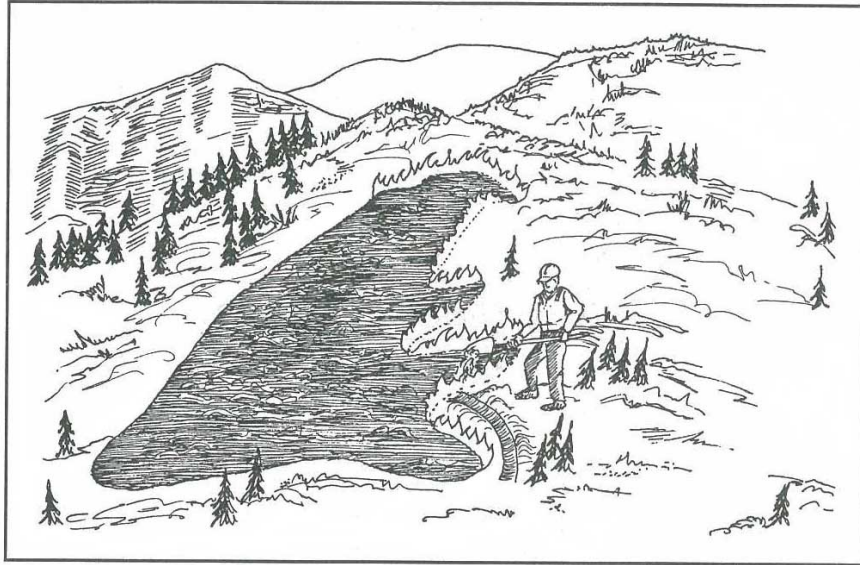

Hotspotting can be used to cool hot portions of a fire and allow firefighters more time to construct fireline or cool certain portions of a fire to prevent it from making a run. Hotspotting can be accomplished by building temporary check lines or applying dirt or water to knock down and cool hot portions of a fire. Hotspotting can be dangerous to firefighters because they are working without an anchor point, can be out-flanked by fire, and they are exposing themselves to intense burning portions of a fire.

FIRELINE LOCATION

Following are some general principles of fireline location:

Locate the fireline as close to the fire edge as possible. This generally means a direct attack which provides firefighters more safety as they can usually get into the burned area for a safety zone.

Always anchor the fireline to a barrier or other control line to prevent being outflanked by the fire (see Figure 8). Barriers can be natural or human made i.e., roads, trails, rivers, lakes, old burns, rocks. Also burn out the fuels between the fireline and the fire edge beginning at the anchor point and continue burning out as the fireline is constructed.

Figure 8 – Begin Fireline At Anchor Point

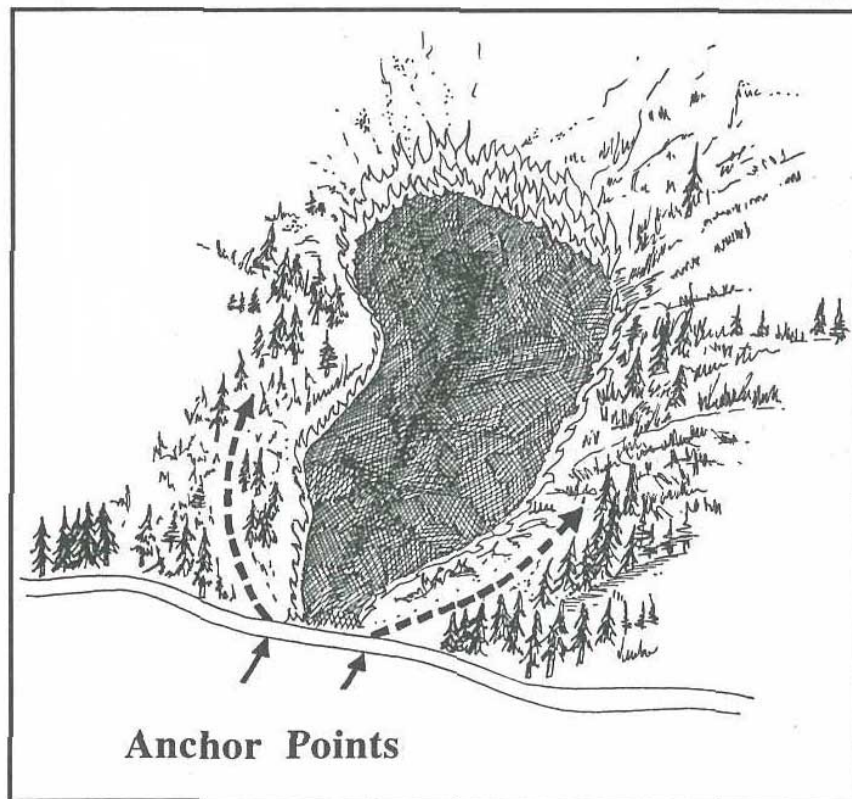

If the fire is spreading rapidly or is too hot for direct attack, place the fireline far enough back from the fire's edge to allow sufficient time for fireline construction and burning out to be completed safely.

Avoid downhill fireline construction with the fire directly below. Building fireline downhill when fire (either wildland fire, burnout, or a backfire) is directly below you can be hazardous and is one of the Watch Out Situations (see Figure 9). Fire spreads more rapidly upslope. Firefighters above the fire building fireline downhill can easily be outflanked or overrun by the fire.

Figure 9 – Building Fireline Downhill



When building fireline downhill of the following safety precautions must be adhered to:

1. The decision is made by a competent fireline supervisor after thorough scouting.
2. Downhill fireline construction should not be attempted when fire is present directly below the proposed starting point.
3. The fireline should not be in or adjacent to a chimney or chute that could burn out while firefighters are in the vicinity.
4. Communication is established between firefighters working downhill and firefighters working toward them from below. When neither crew can adequately observe the fire, communications will be established between the crews, supervising overhead, and a lookout posted where the fire's behavior can be continuously observed.

5. Firefighters will be able to rapidly reach a safety zone from any point along the line if the fire unexpectedly crosses below them.
6. Downhill fireline will be securely anchored at the top. Avoid underslung line if at all practical.
7. Burning out should be done as the fireline progresses, beginning from the anchor point at the top. The burned out area provides a continuous safety zone for firefighters and reduces the likelihood of fire crossing the line.
8. Be aware of and recognize the Watch Out Situations.
9. Full compliance with the Fire Orders is assured.
10. Implement LCES.

Fireline should not be constructed in or adjacent to chutes or box canyons that can channel the fire and produce extreme fire behavior (see Figure 10).

Figure 10 – Fireline Constructed Near Chute or Box Canyon

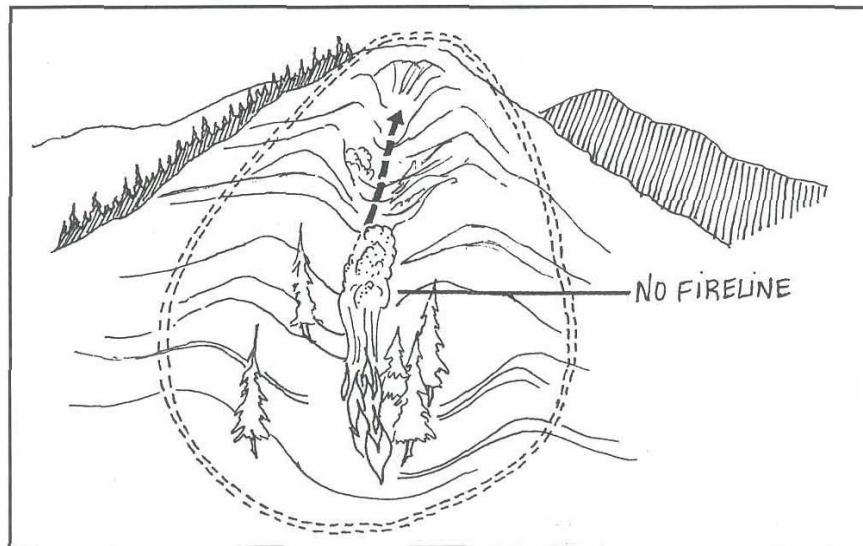

Make the fireline as short as possible (see Figure 11). Tie ends of fingers together with a fireline and promptly bum out. Cold trailing is a method of using the extinguished edge of a fire as the fireline. The cold fire edge must be carefully inspected to detect any fire and every live spot must be lined and extinguished. Cold trailing can shorten the fireline to be constructed, but must be accomplished with caution.

Figure 11 – Short Fireline

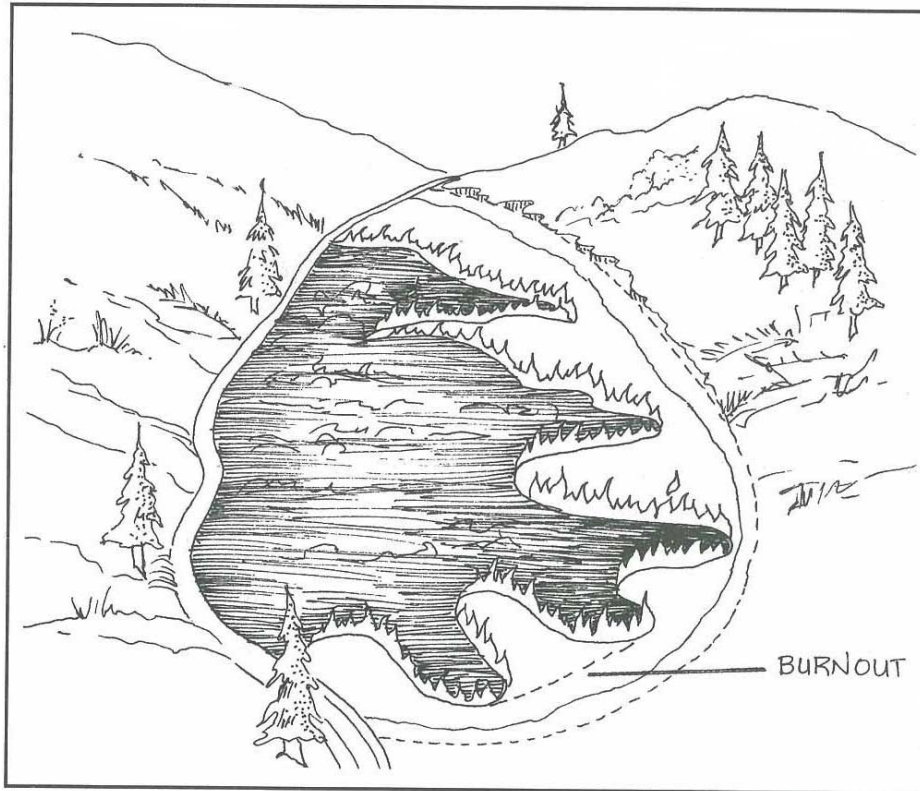

Capitalize on existing barriers to fire spread in selecting fireline location.

When possible put the fireline through open areas to reduce clearing work.

Avoid sharp angles in the fireline.

Block off high hazard fuels where possible by leaving them outside the fireline.

When constructing fireline on a ridgetop, locate the fireline on the back side of the ridge (see Figure 12).

Figure 12 – Properly Located Fireline On Ridgetop

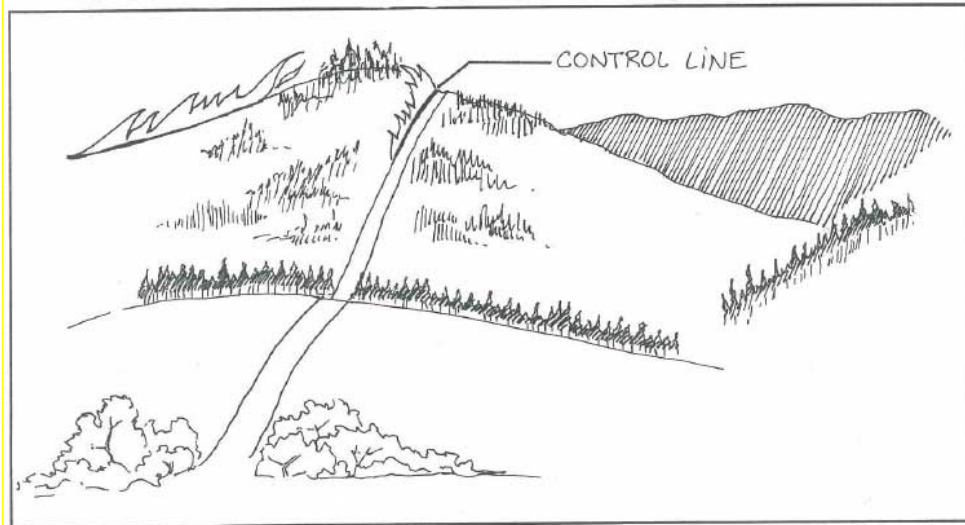

When constructing fireline in the bottom of a canyon locate line on the opposite side to prevent underslung line and the need for cup trenching (see Figure 13).

Figure 13 – Properly Located Fireline In Canyon Bottom

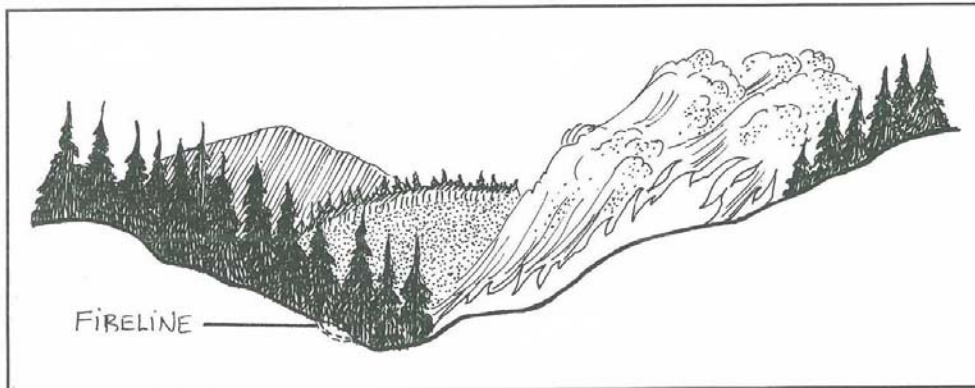

Locate the fireline far enough away from burning snags to enclose them if they fall over or are cut down (see Figure 14).

Figure 14 – Properly Located Fireline With Snags Close to Fire Edge

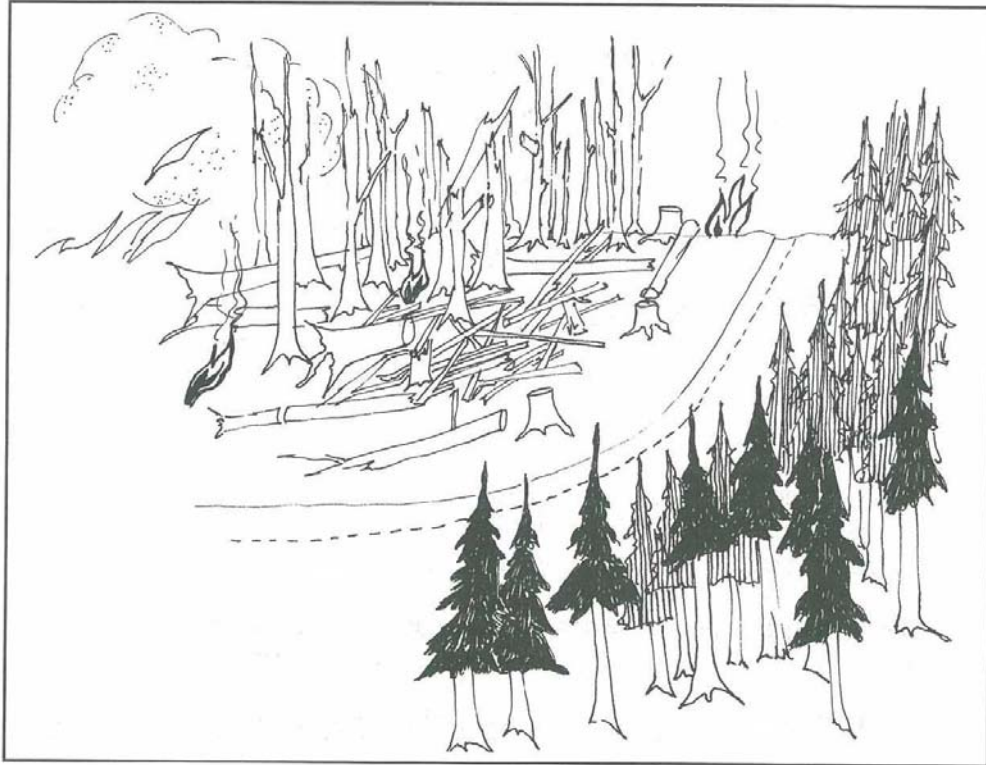

Encircle the area where spot fires are so numerous that individual control of them is impracticable.

Where a definite topographic feature, such as a ridge, cannot be used for fireline location, oblique (slanting) lines should be used for frontal attack to pinch off the fire head, rather than a line squarely across the front.

Take advantage of the normal daily shift between local up-canyon drafts during the day and down-canyon winds during the night. Unless general winds counter the effect of local drafts, fires generally burn up-canyon during the day and down-canyon at night.

FIRELINE FLAGGING

Line location is a common practice in some types of terrain and fuels, particularly when a fire is burning in timber.

When locating firelines, consider the following flagging techniques:

1. When tying and positioning individual flags, allow enough time for crew or mechanical equipment to construct line before fire edge approaches flag line.
2. Avoid flagging long sections of line. Flagging long sections of line separates you from your crew and equipment creating possible communication problems and unsafe situations.
3. Use a high visibility/reflective color whenever possible that can be easily seen in day light or night time conditions. Notify the crews constructing fireline what color of flagging was used.
4. Deploy an adequate amount of flagging for conditions. Flagging must be deployed heavier for night operations and/or during heavy fuel buildups because of poor visibility. Resources that can't find flag lines are nonproductive and may be put at risk during critical fire behavior situations and/or when working in adverse topography.
5. Avoid flagging dog legs or sharp angles. Whenever possible flag away from snags, widow makers, and other potentially hazardous areas.
6. If possible avoid flagging underslung line conditions which will require trenching and future holding problems. Depending on the size or the complexity of the fire, more than one individual with radio(s) may be required to accomplish this task. Whether locating line downhill or uphill, the outside perimeter will take on an overall wedge shape configuration and all unburned material should be burned out. On larger fires, an indirect method of attack may be warranted requiring flag lines to take advantage of ridges running parallel to the main fire. The unburned area then should be backfired.
7. If an existing flag line must be rerouted, remove enough flagging to ensure crews or other adjoining resources will not mistake the old flagged line for the new flagged line. This situation can create nonproductive periods and expose crews to potentially unsafe conditions. Use a different color flagging and make sure crews following behind are aware of the change.

8. At night, when cold trailing, constructing parallel line across unburned fingers, and/or flagging indirect line, use two or more individuals with headlamps. The lead line locator searches out and determines where the line should be located. Once this individual has determined the approximate line location, a second person commences flagging staying on line with the lead person's headlamp. A third person may be necessary when there are larger fingers to assist in keeping the middle flagger on line with the lead line locator. This is accomplished by positioning the rear flagger at the opposite side of the finger from the lead line locator in a location where they can keep the middle flagger centered between their two locations. Once all three individuals are in position, there are two common alternative flagging procedures recommended. The first alternative requires the middle flagger to commence flagging, working away from the rear flagger keeping visual contact with the headlamps of the rear flagger and lead line locator. The second alternative requires the middle flagger to move to a position normally half way between the rear flagger and the lead line locator. After the center flagger is in position, the rear flagger commences flagging to the center flagger's position. After the first half of the line is flagged in, one of the two individuals remains at that location and the other commences flagging to the lead line locator's position.
9. Spot fires should be flagged and tagged with a written note. Flag lines leading to spot fires should originate from the existing main line. Always tie and secure a note or write directly on the flagging the following information:
 - a. Date found
 - b. Time found
 - c. Size of spot fire
 - d. Location from main fireline
 - e. Determine if spot is lined or unlined
 - f. Color(s) of flagging used to flag the spot fire
 - g. Name of crew or individual reporting spot

It is suggested that each time the spot is checked, the time, date and individual's name be recorded on the initial note.

10. It is necessary to understand the relationship of the flag line to the proposed control line. This must be communicated to the resources responsible for constructing the line. It becomes especially important when numerous saw teams are constructing line in heavy fuel conditions. In this situation the flag line is normally positioned at the point that will end up being the outside green edge of the completed line. The initial saw team should commence cutting its assigned strip just to the inside of the flag. This provides additional saw teams an edge to cut from and/or a location to place their cut material.
11. Always designate whether your flag line is to remain intact during line construction. Many times when using a saw team during night periods the operator will cut down a flag line in scattered brush or timber leaving only stubs. This situation may cause the personnel scraping the line to become disoriented, resulting in production loss.
12. Hazards such as bees, hornets, wasps and/or snags should be identified using yellow and black striped flagging. This is a universal flagging color recognized by most wildland firefighting agencies.
13. Escape routes and safety zones should be identified using lime green flagging.

FIRELINE CONSTRUCTION

Following are some of the more important principles of fireline construction:

Make fireline no wider than necessary (see Figure 15). The time and energy saved by keeping firelines no wider than necessary to stop a fire can be better utilized in construction of more fireline to encircle or control the fire.

Figure 15 – Make Fireline No Wider Than Necessary

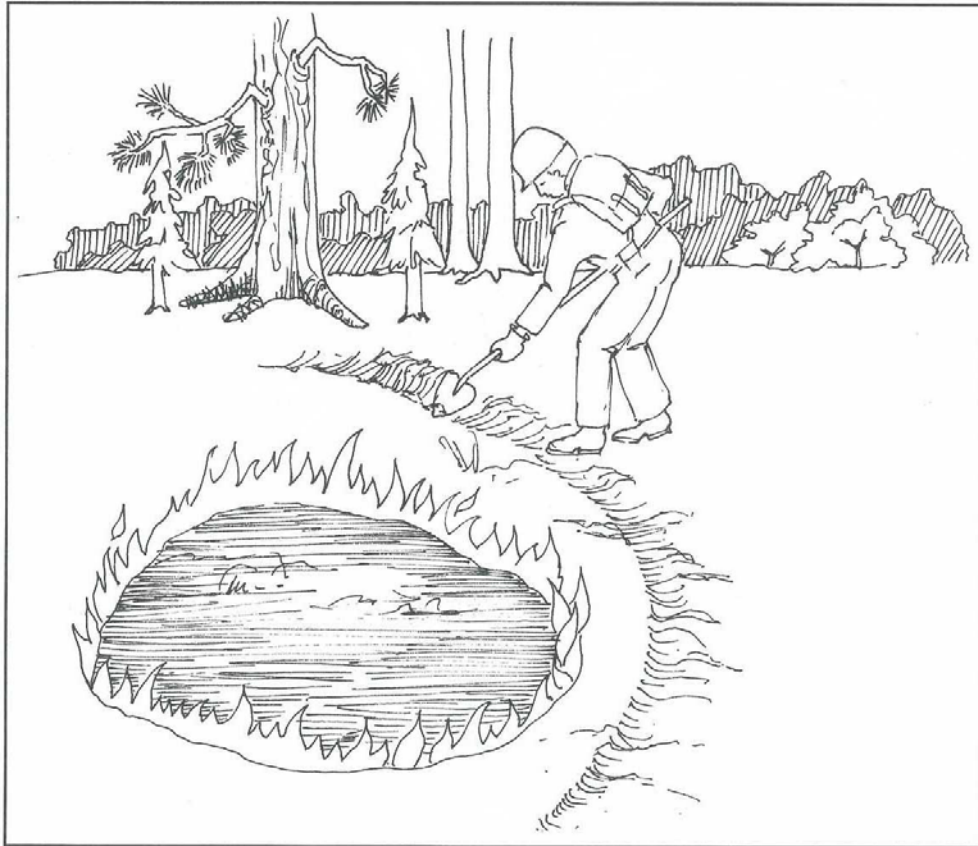

Clean all fireline to mineral soil for all or part of width (see Figure 16). Cleaning a fireline to mineral soil prevents the fire from spreading through fuel across the fireline, particularly dead roots. However, constructing fireline to mineral soil may not be practical in some types of fuel such as bogs, peat, tundra, etc.

Figure 16 – Fireline Cleaned To Mineral Soil

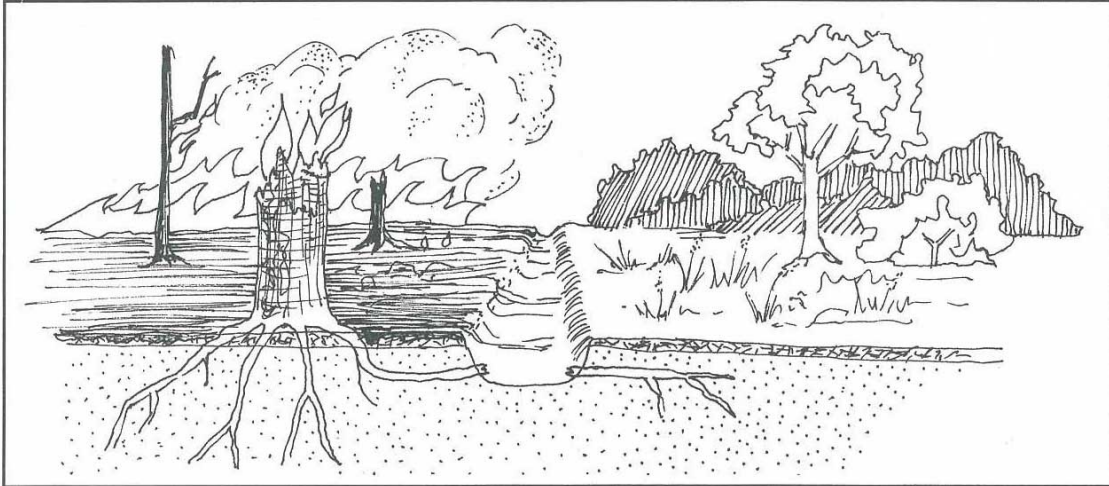

Scatter charred or burning material from fireline construction inside the burned area.

Unburned material from fireline construction is generally scattered outside the fireline. Unburned material can be scattered on either side of the fireline, provided this does not increase burning and heat at the line and make the line too hard to hold or complicate mopup; if fuel is needed for burning out, place inside the fireline.

Underslung or undercut fireline is fireline constructed across a slope below the fire. Protect underslung or undercut firelines from rolling material by building a cup trench (see Figure 17). A cup trench is sometimes called a roll trench or "V" trench.

Figure 17 – Cup Trench Below A Fire On A Slope

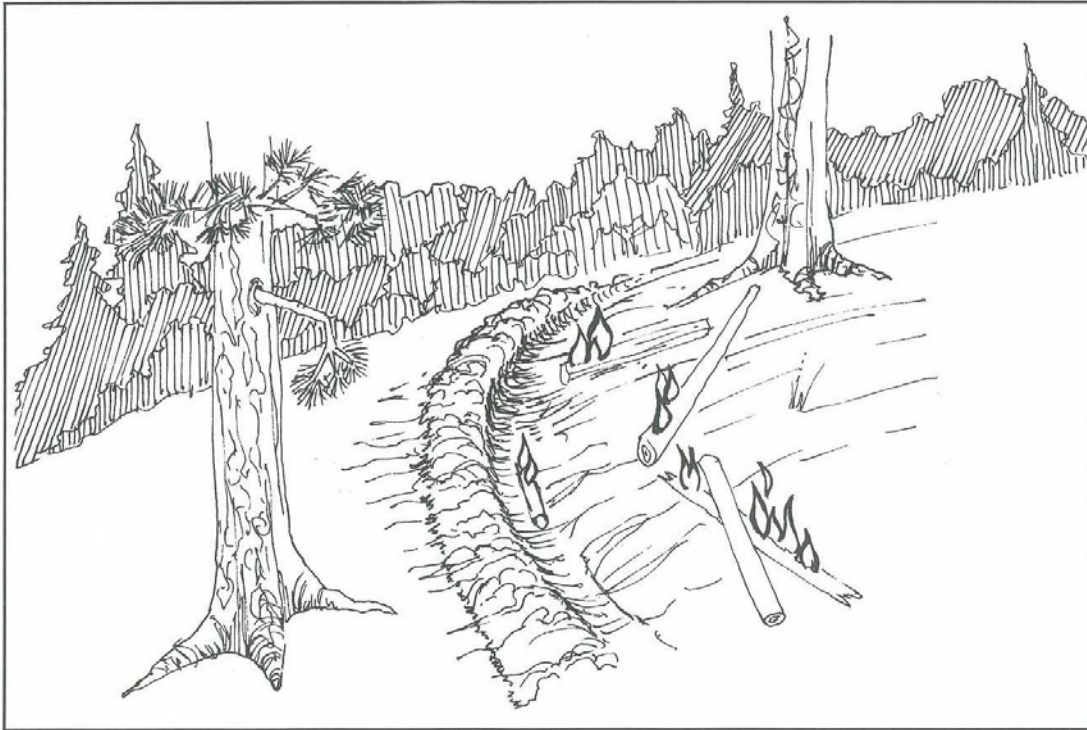

Effectiveness of a given width of line can be increased by using dirt or water to cool down adjacent fire.

Fuels outside the fireline can be pretreated with retardant or foam, covered with dirt, or wet down. (see Figure 18).

Figure 18 – Protection of Stumps and Logs Outside Fireline

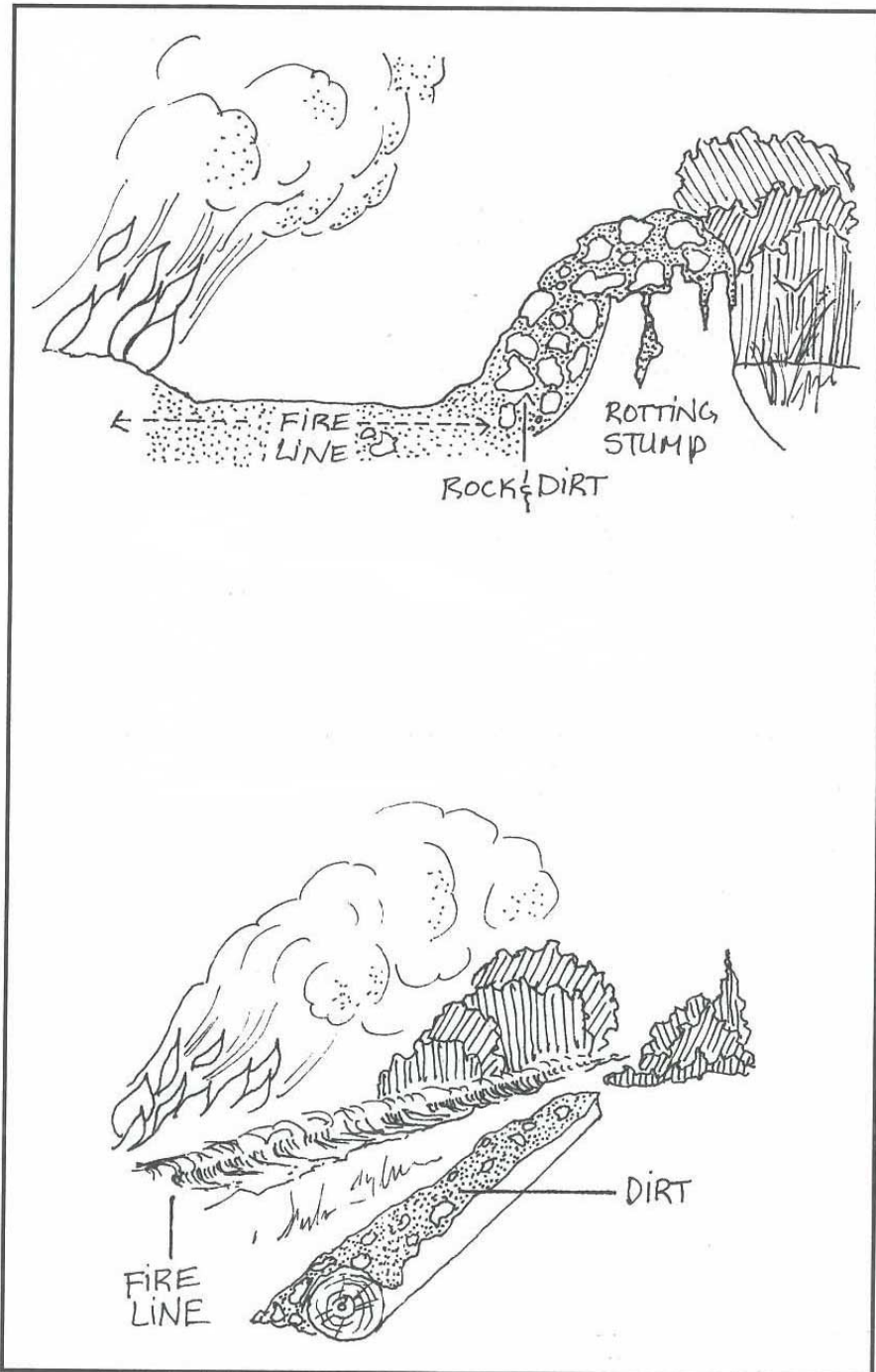

Remove low hanging limbs from trees on both sides of the fireline to prevent the fire from spreading across the line (see Figure 19).

Figure 19 – Low Hanging Limbs Can Spread Fire Across Fireline



Heat can ignite fuel across or above the fireline even if flames do not reach the fuel. Radiant or convective heat may ignite fuel on the opposite side of a fireline which is too narrow or has too little overhead clearance.

Radiation is transmission of heat through the air by rays. The heat may be radiated in all directions, horizontally as well as vertically (similar to heat radiated from a stove). Fuels too close to intense heat can be ignited even if they are not in contact by flame (see Figure 20).

Figure 20 – Fire Spread Across Fireline By Radiation

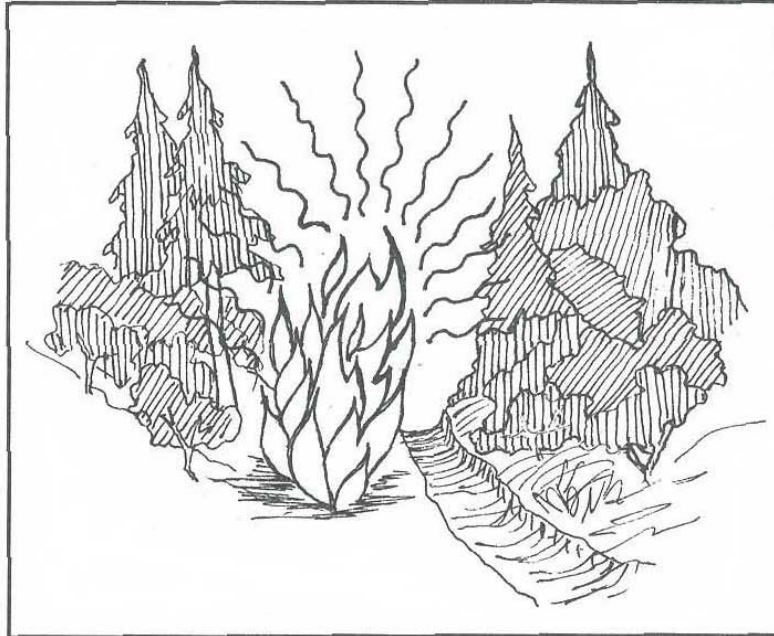

Convection is transmission of heat by currents of air. Convection currents preheat the fuel ahead of a fire (across and/or above the fireline) and make the fuel easier to ignite (see Figure 21). If too close, fuel can actually be ignited by convection currents.

Figure 21 – Fire Spread Across Fireline By Convection

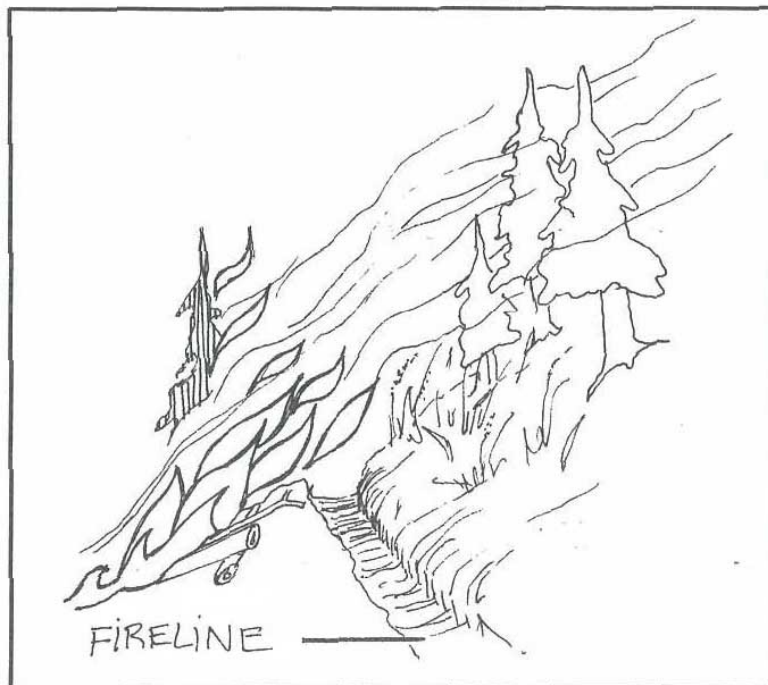

Anything that affects how a fire burns must be considered in deciding the width of fireline needed to hold or control a fire. The hotter or faster the fire burns, the wider the control line must be. Six important factors in determining fireline width are: 1) fuel, 2) slope, 3) weather, 4) part [head, flanks, rear] of fire, 5) size of fire, and 6) possibility of cooling.

The width of a fireline is generally accomplished by clearing and scraping (see Figure 22). Brush, trees, and logs must be removed by clearing a strip wide enough to prevent the flames, radiation or convective heat or any combination of the three from igniting fuel across the fireline. All flammable material must be removed by scraping to mineral soil a strip wide enough to prevent fire from spreading through roots and other ground fuel across the fireline. The scraped strip must be placed on the outside (side away from the fire) of the cleared strip.

Figure 22 – Fireline Showing Cleared and Scraped Area

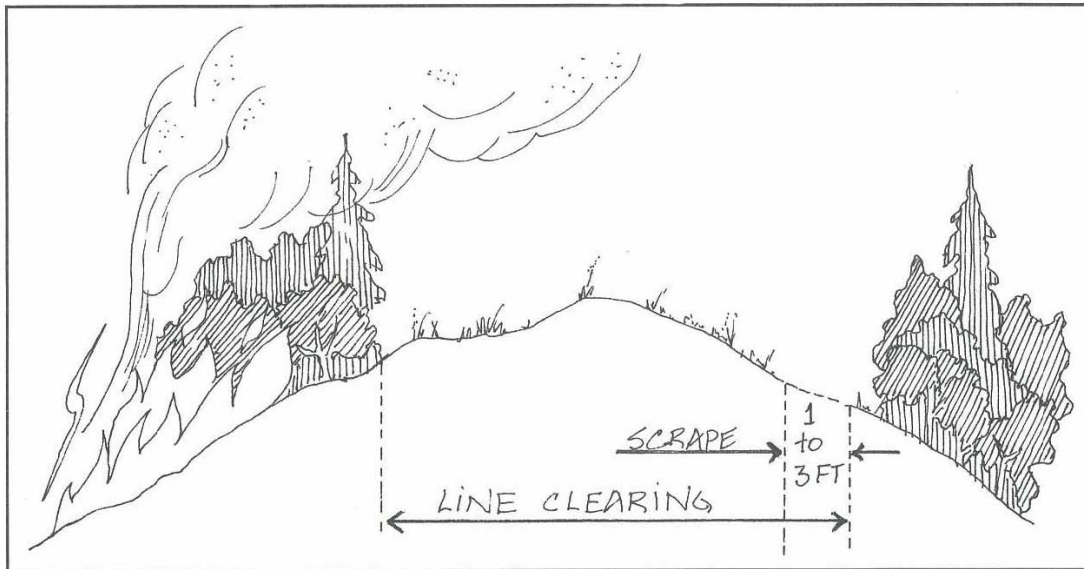

A general guideline for determining the width of a fireline is that it should be one and one half times as wide as the dominate fuel is high. The scraped portion of a fireline is generally one to three feet wide. However, in timber a fireline is generally 20 to 30 feet wide with a three to four foot scrape. A fireline in timber should be constructed to stop the burning surface and lower aerial fuels. Most firelines will be unsuccessful in stopping a crown fire in timber.

COYOTE TACTIC

The "coyote tactic" consists of a progressive line construction technique involving self-sufficient crews who build fireline until the end of an operational period, remain overnight (RON) at/near that point, and then begin again on the next operational period. Crews should be properly equipped and be prepared to spend several shifts on the line with minimal support from the incident base.

Operations and Logistical Considerations

1. Meals during "coyote tactic" operational periods may consist of rations and/or sack lunches.
2. The "coyote tactic" generally will not last over three or four operational periods for any one crew.
3. Division supervisors will be responsible for establishing on and off operational period times.
4. Operations personnel will ensure that crews understand "coyote tactic" policy before the crews go to the line.
5. Crews working "coyote tactic" operational periods will be re-supplied on the fireline as close as possible to the RON point.

Coyote Tactic Guidelines

1. Can "coyote tactic" meet the Fire Orders, Watch Out Situations and LCES?
2. Can emergency medical technicians (EMTs) be provided on the line?
3. Can a timely medivac plan be implemented?
4. Can daily communications (verbal and written) be maintained?
5. Can daily logistical support of food and water be provided?
6. Does each individual crew boss feel comfortable with the assignment?

Crew bosses, strike team/task force leaders and division supervisors should consider the following prior to and during a coyote assignment:

1. Operations personnel should consider bringing with them in their gear a toothbrush/paste, extra pair of socks/underwear, light coat, double lunch, space blanket, etc.

2. Anticipating early in the operational period where the crew(s) will remain overnight (RON) and that the RON location provides for safety and logistical needs of the crew, i.e., main fire poses no threat, helicopters can long line or land at site, personnel are provided semi-flat ground to sleep on, there is adequate firewood for warming fires, etc.
3. Anticipating re-supply needs early in the operational period and placing those orders early through appropriate channels. Crew leaders should make arrangements to have qualified individuals at RON locations to accept those orders by long line or internal helicopter operations.
4. Bears may be a valid concern in some areas and personnel should take appropriate measures to prevent problems with food, trash, etc. It is a common practice to leave one or more individuals with radio communications at the RON location to coordinate the "back haul" of trash or the pre-positioning of re-usable supplies to advanced RON locations.
5. How will crew time and commissary items be managed during the operation? Normally this function can be provided by using in/out bound helicopter flights at the RON location, or the time is turned in upon returning to the incident base.
6. How will medical emergencies be managed during the operation? An emergency medical technician may need to be provided at the RON location.

HANDCREW PRODUCTION RATES

Table 1 shows average overall handcrew production rates for initial attack. Table 2 shows Type 1 and 2 handcrew production rates for sustained attack. Remember, these tables are guidelines only as there are many factors that influence a handcrew's fireline production.

Table 1 – Handcrew Production, Initial Attack
(Chains per hour per person)

Fire behavior fuel model	Conditions used in	Construction rate
1 Short grass	Grass Tundra	1.0
2 Open timber Grass understory	All	3.0
3 Tall grass	All	0.7
4 Chaparral	Chaparral High pocosin	0.4 0.7
5 Brush (2 feet)	All	0.7
6 Dormant brush/ hardwood slash	Alaska black spruce All others	0.7 1.0
7 Southern rough	All	0.7
8 Closed timber litter	Conifers Hardwoods	2.0 10.0
9 Hardwood litter	Conifers Hardwoods	2.0 8.0
10 Timber (litter and understory)	All	1.0
11 Light logging slash	All	1.0
12 Medium logging slash	All	1.0
13 Heavy logging slash	All	0.4

Table 2 – Handcrew Production, Sustained Attack

Chains per hour per crew (Chains per hour per person)

Fire behavior fuel model		Conditions used in	Crew category	
			Type 1	Type 2
1	Short grass Tundra	Grass	30 (1.50)	18 (0.90)
2	Open timber/ grassy understory	All	24 (1.20)	16 (0.80)
3	Tall grass	All	5 (0.25)	3 (0.15)
4	Chaparral High pocosin	Chaparral	5 (0.25)	3 (0.15)
5	Brush (2 feet)	All	6 (0.30)	4 (0.20)
6	Dormant brush/ hardwood slash	Black spruce	7 (0.35)	5 (0.25)
7	Southern rough	All	4 (0.20)	2 (0.10)
8	Closed timber litter Hardwoods	Conifers	7 (0.35)	5 (0.25)
9	Hardwood litter Hardwoods	Conifers	28 (1.40)	16 (0.80)
10	Timber (litter and understory)	All	6 (0.30)	4 (0.20)
11	Light logging slash	All	15 (0.75)	9 (0.45)
12	Medium logging slash	All	7 (0.35)	4 (0.20)
13	Heavy logging slash	All	5 (0.25)	3 (0.15)

FIRELINE EXPLOSIVES

Fireline explosives are linear explosives that enable crews to construct firelines under certain conditions much faster and with less environmental impact than conventional methods. The quality of line constructed varies from a nearly finished line in light brush or grass fuels to a lower quality line than required in heavy brush and slash fuel types. However, even in heavy brush and slash the cleaning action of explosives can enhance access and effectiveness of fire crews who finish the line. Fireline explosives are also effective in falling hazard trees during line construction, but even more so during the mopup and rehabilitation of a fire.

All fireline explosives are tested by the Bureau of Mines to ensure that they will not accidentally detonate in conditions found in the field. They are impact tested to insure that they will not detonate when paracargoed even if the parachute fails to deploy. They will not detonate when shot with a 30 caliber projectile and they will not mass detonate if accidentally caught on fire. Only those fireline explosives that pass the tests and that are accepted on the qualified products list can be used for this activity. In conjunction with fireline explosives, the exploding bridgewire detonator (EBW) system is exclusively used to ensure the safest system for building firelines.

Advantages of Fireline Explosives

As labor and overhead costs rise, fireline blasting offers real time savings. Smaller crews may be used to suppress fires because less cutting and/or digging hand line is required, particularly in heavy fuels or ground cover. Increased speed of building the line can save wildland resources. Sometimes smaller crews equipped with explosives can be delivered to a fire faster than larger, conventionally equipped crews. Other advantages include:

- Brush and other debris (fuel and slash) are scattered rather than piled next to the finished line.
- Mineral soil in the line is loosened and easy to dig for use in hotspotting and mopup.
- A fine layer of soil dusts fuels close to the line and acts as a retardant. Blasting is generally more environmentally sound than using hand tools or dozers.
- Fireline explosives can be paracargoed into extremely remote locations.

Disadvantages of Fireline Explosives

- Use of explosives for fuels management or wildfire projects can be limited by lack of adequate explosive storage facilities.
- Personnel using fireline explosives must be carefully selected and thoroughly trained.
- Transportation and handling demand special precautions.
- Cost (very expensive)

Procedures

A typical blasting team is made up of the Blaster-In-Charge, Assistant Blaster, and Guards/Flaggers (see Figure 23). Guards are numbered by the Blaster-in-Charge.

Figure 23 – Example of Explosive Layout and Placement of Guards

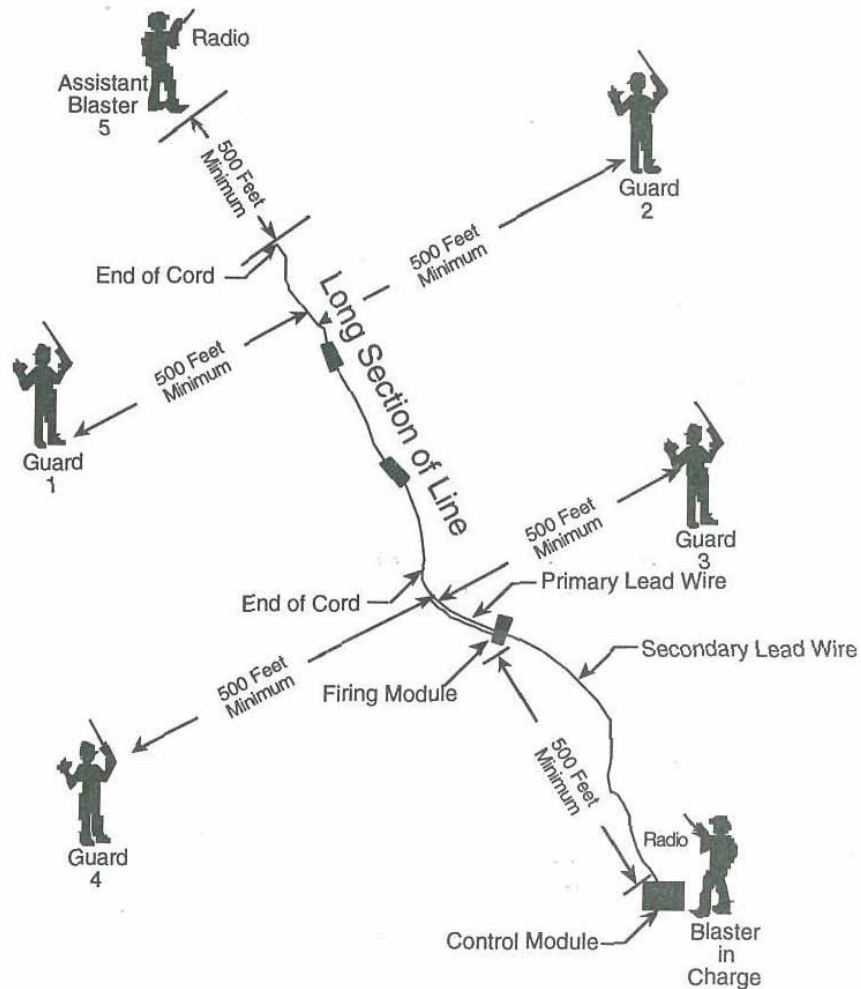

The Blaster-in-Charge will plan communications with designated blasting team regarding:

- Safety
- Layout and firing procedures
- Location of guards and/or flaggers
- Length of explosive that can be safely guarded and controlled

The blasting team should have a clear channel while in actual operations. Each team member should have a radio.

The Blaster-in-Charge must brief the team and ensure good communications within the blasting team and with personnel in the division using fireline explosives (see Figure 24). Guards are numbered by the Blaster-in-Charge.

Figure 24 – Example of Placement of Guards When Blasting Close to Roads or Any Public Facility

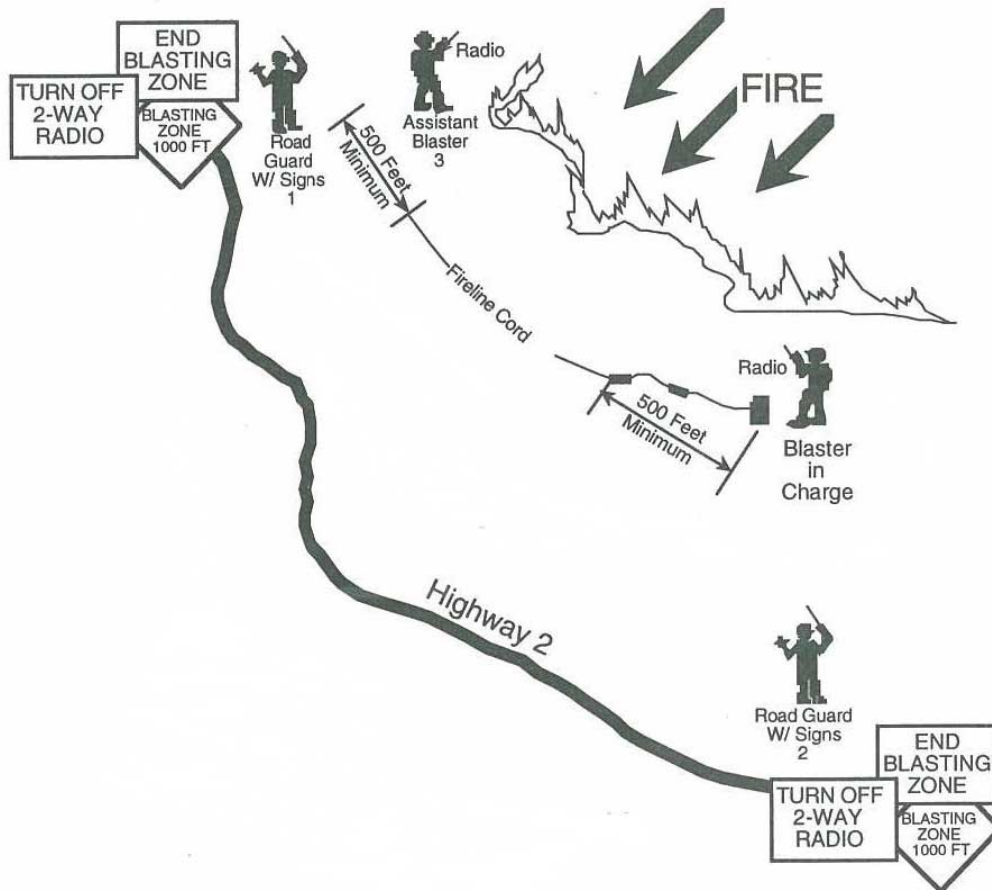

MOPUP

After primary fireline construction is completed many things remain to be done to make the fireline "safe" and put the fire out. This work is called mopup. The objective of mopup is to put out all fire embers or sparks to prevent them from crossing the fireline.

A certain amount of mopup work is done along with line building. Mopup becomes an independent part of firefighting as soon as the spread of the fire is stopped and all line has been completed. Ordinarily, mopup is composed of two actions; putting the fire out, and disposing of fuel either by burning to eliminate it, or removing the fuel so it cannot burn.

The principles of mopup are as follows:

Start work on each portion of fireline just as soon as possible after the fireline has been constructed and burning out is completed. Treat the most threatening situations first.

Allow fuel to burn up if it will do so promptly and safely.

On small fires, all fire should be extinguished in mopup, whenever quantities of burning material are not so large as to make this impracticable.

Mopup considerations on large fires include potential/predicted weather and fire behavior, fuels involved, social impacts, etc. Generally the fire perimeter is mopped up a specified distance; i.e., 100 feet, 500 feet, etc.

On large fires, completely mop up enough of the area adjacent to the line to be certain no fire can blow, spot, or roll over the fireline under the worst possible conditions anticipated (see Figure 25).

Page 45 Figure 25 – Mopup Area Adjacent To Line

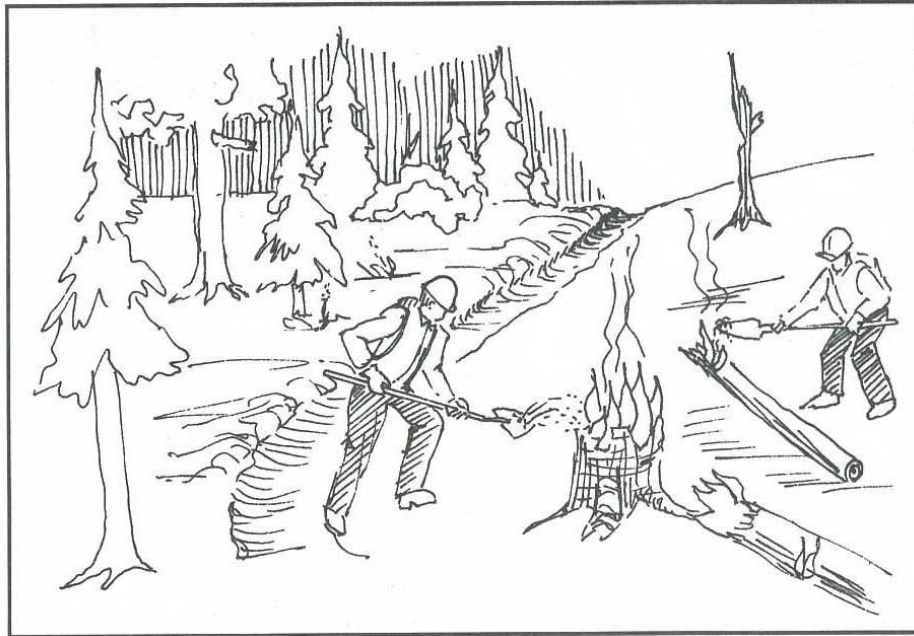

Search for smoldering spot fires.

All smoldering material not put out with water or dirt should be spread well inside the fireline.

Consider potential for problems from snags, punky logs, and fuel concentrations outside of the fireline

Look for and dig out burning roots near the fireline.

Use water wherever possible and practical in mopup.

Use water sparingly, but use enough to do the job. Match the amount of water to the job. Let no person use water alone, but always with another person with a hand tool to scrape or stir the fuel while applying water.

Add wetting agents to water to mop up deep burning fuels such as peat, duff or needles. Scrape or stir the fuel while applying water. In dry mopup, stir and mix hot embers with dirt.

Separate masses of large fuel to reduce heat and danger of spotting.

Figure 26 – Separate Masses of Large Fuel

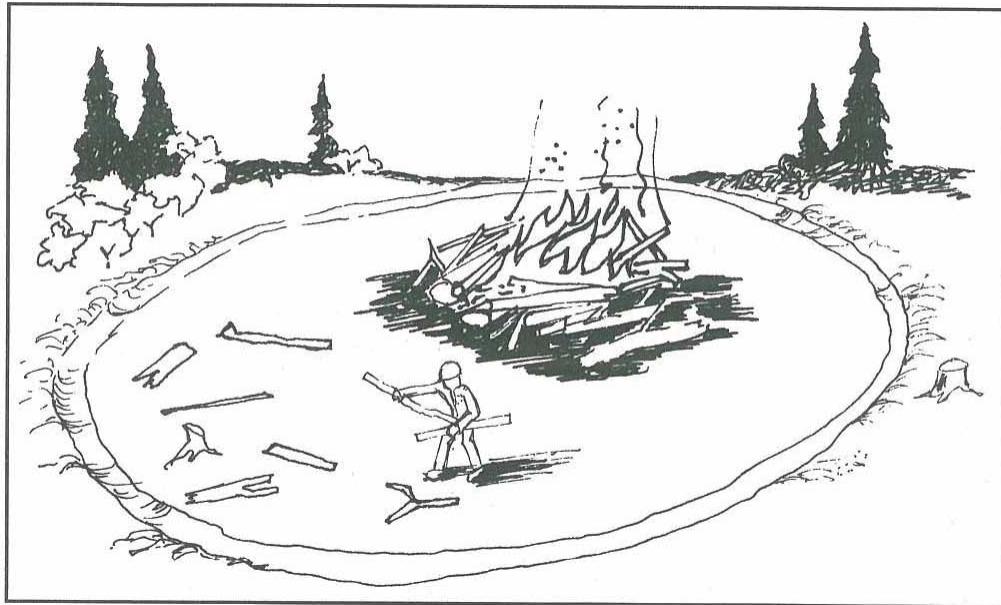

Eliminate all snags inside the fireline that could result in spotting or fire spread across the fireline (see Figure 27). Exercise extreme caution when working near snags as they can fall over anytime.

Figure 27 – Eliminate Problem Snags

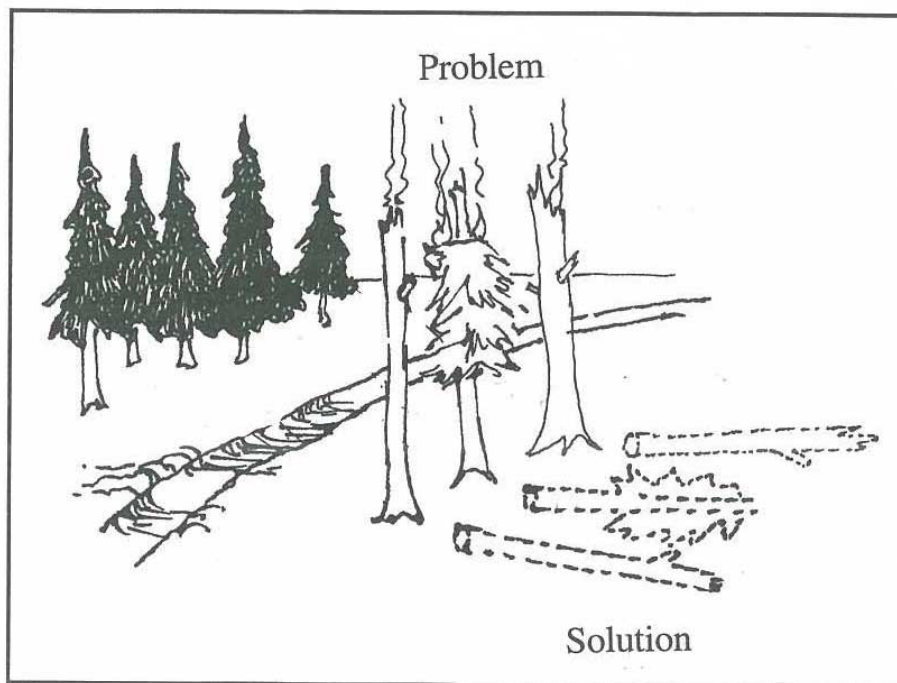

Put all rolling material into such a position it cannot possibly roll across the fireline (see Figure 28).

Figure 28 – Turn Logs Perpendicular To Slope

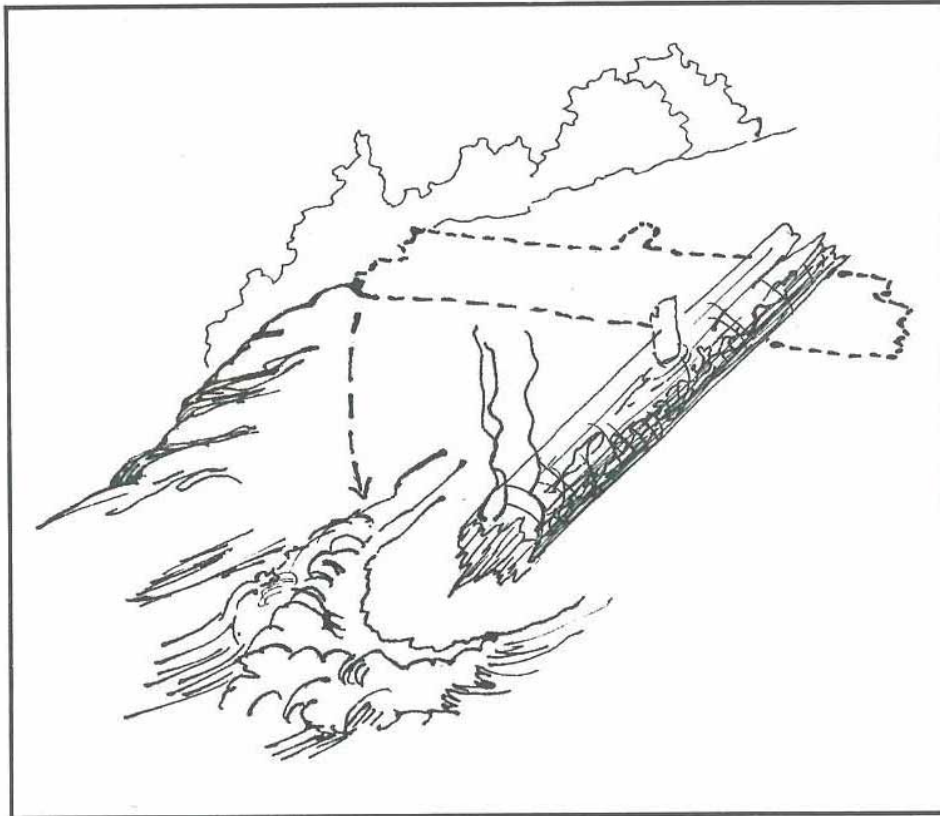

Dig trenches immediately below all heavy material which might roll across the fireline.

Look for indications of hot spots. Some indicators are gnats swarming, white ash, ground which shows pin holes, and wood boring insects. Feel with hands for possible smoldering spots. Use caution to prevent burning of hands and/or fingers.

Portable infrared devices may be available to assist in locating "hot spots." If so, use with a trained operator.

MINIMUM IMPACT SUPPRESSION TACTICS (MIST)

The following guidelines for MINIMUM IMPACT SUPPRESSION are for agency administrators, incident management teams, and firefighters to consider. Some or all of the items may apply, depending upon the situation.

Managers and firefighters need to ask, "Are suppression and mopup tactics commensurate with the fire's potential to spread and cause resource damage in this land allocation? What tactics are adequate for the behavior of this fire? Are our tactics causing long-term adverse impacts on the land? Will MIST compromise firefighter safety?'

One evident tactic is the choice of fireline to use. There are good examples where cattle trails in fine fuels on 30% slopes were used as fireline and as the anchoring point for burnout. There are bad tactical examples in similar or lighter fuels where blade-wide dozer lines were used. In some cases, several blade-wide parallel dozer lines through grass/scab areas were made. Dozer lines are now in places where vehicle trails did not exist, thus opening additional area to possible destructive vehicle use.

Good tactical examples exist on easily accessible ground where fire spread was halted by engines driven along the fire perimeter using water for holding and extinguishing fire spread. In similar situations, bad examples exist where dozer lines were constructed parallel to existing gravel roads that could have served as adequate firelines.

Another very evident tactic that causes long-term lasting impact and resource loss is tree cutting. A bad tactical example exists in a situation, where up to 400 yards inside the fire's perimeter, living ponderosa pine that had minimum fire in the base have been cut. Instead of using hand pumps and/or dirt, the chain saw served as a means to extinguish the fire from the base of these trees, which often have evidence of past fires extinguished naturally or by some other means. The question needs to be asked. "Even if a tree is on fire and may never be used for timber volume, why is it being cut?" Dead, standing trees are acknowledged as a resource for some specific management objectives.

Consider

COMMAND AND GENERAL STAFF

- Evaluate each and every suppression tactic during planning and strategy sessions to see that they meet agency administrator objectives and minimum impact suppression guidelines.
- Include agency resource advisor and/or local representative in above sessions.
- Discuss MIST with other overhead during operational period briefings, to gain full understanding of tactics.
- Ensure MIST are implemented during line construction **as** well as other resource disturbing activities.

PLANNING SECTION

- Use resource advisor to evaluate that suppression tactics are commensurate with land/resource objectives, and incident objectives. Use an assessment team for a different perspective of the situation.
- Use additional consultation from "publics" or someone outside the agency, especially if the fire has been, or is expected to be, burning for an extended period of time.
- Adjust line production rates to reflect the minimum impact suppression tactics.
- Use brush blade for line building-when dozer line is determined as necessary tactic.
- Leave some trees randomly in fireline.
- Ensure that instructions for minimum impact suppression tactics are listed in the Incident Action Plan.
- Detail objectives for extent of mopup necessary - for instance:
"_____ distance within perimeter boundary."
- If helicopters are involved, use long line remote hook in lieu of helispots to deliver/retrieve gear.

- Anticipate fire behavior and ensure all instructions can be implemented safely.
- Consider coyote camps versus fixed camp site in sensitive areas.
- If extremely sensitive area, consider use of portable facilities (heat/cook units, latrines).

OPERATIONS SECTION

- Emphasize minimum impact suppression tactics during each operational period briefing.
- Encourage strike team leaders and crew superintendents to provide input on firefighter safety as it relates to MIST.
- Explain expectations for instructions listed in Incident Action Plan. Consider showing minimum impact suppression slide-tape program or video to the crews upon arrival at airport/incident.
- Consider judicious use of helicopters-consider long lining instead of helispot construction.
- Use natural openings so far as practical.
- Consider use of helibucket and water/foam before calling for air tanker/retardant.
- Monitor suppression tactics/conditions.

LOGISTICS SECTION

- Ensure actions performed around areas other than incident base, i.e., dump sites, camps, staging areas, helibases, etc., result in minimum impact upon the environment.

DIVISION/GROUP SUPERVISOR AND STRIKE TEAM/TASK FORCE LEADER

- Ensure crew superintendents and single resource bosses understand what is expected.
- Discuss minimum impact tactics with crew,
- Ensure dozer and falling bosses understand what is expected. If helicopters are involved, use natural openings as much as possible; minimize cutting only to allow safe operation.
- Avoid construction of landing areas in high visitor use areas.
- Monitor suppression tactics/conditions.

CREW SUPERINTENDENTS

- Ensure/monitor results expected.
- Discuss minimum impact suppression tactics with crew.
- Provide feedback on implementation of tactics-were they successful in halting fire spread; what revisions are necessary.
- Look for opportunities to further minimize impact to land and resources during the suppression and mopup phase.
- Emphasize use of lookouts.

MIST Implementation Guidelines

Minimum impact suppression is an increased emphasis to do the job of suppressing a wildland fire while maintaining a high standard of caring for the land. Actual fire conditions and your good judgment will dictate the actions you take. Consider what is necessary to halt fire spread and ensure it is contained within the fireline or designated perimeter boundary.

SAFETY

- Safety is of utmost importance.
- Constantly review and apply the Watchout Situations and Fire Orders.
- Be particularly cautious with:
 - burning snags you allow to burn down
 - burning or partially burned live and dead trees
 - unburned fuel between you and the fire
 - hazard trees (identify them with either observer, flagging, and/or glow-sticks)
- Be constantly aware of the surroundings, of expected fire behavior, and possible fire perimeter one or two days hence.

FIRELINING PHASE

- Select procedures, tools, equipment that least impact the environment.
- Give serious consideration to use of water as a firelining tactic (fireline constructed with nozzle pressure, wetlining)
- In light fuels:
 - cold-trail line
 - allow fire to burn to natural barrier
 - consider burn out and use of gunnysack or swatter
 - constantly recheck cold trailed fireline

- if constructed fireline is necessary, use minimum width and depth to check fire spread
- In medium/heavy fuels:
 - consider use of natural barriers and cold-trailing
 - consider cooling with dirt and water, and cold-trailing
 - if constructed fireline is necessary, use minimum width and depth to check fire spread
 - minimize bucking to establish fireline; preferably build line around logs
- Aerial fuels:-brush, trees, and snags:
 - adjacent to fireline: limb only enough to prevent additional fire spread
 - inside fireline: remove or limb only those fuels which if ignited would have potential to spread fire outside the fireline
 - brush or small trees that are necessary to cut during fireline construction will be cut flush with the ground
- Trees, burned trees, and snags:
 - MINIMIZE cutting of trees, burned trees, and snags
 - live trees will not be cut, unless determined they will cause fire spread across the fireline or seriously endanger workers. If tree cutting occurs, cut stumps flush with the ground
 - scrape around tree bases near fireline if hot and likely to cause fire Spread
 - identify hazard trees with either an observer, flagging and/or glowsticks

- When using indirect attack:

- do not fall snags on the intended unburned side of the constructed fireline, unless they are an obvious safety hazard to crews working in the vicinity
- on the intended bum-out side of the line, fall only those snags that would reach the fireline should they burn and fall over. Consider alternative means to falling, i.e., fireline explosives, bucket drops.
- review items listed above (aerial fuels; brush, trees, and snags)

MOPUP PHASE

- Consider using 'hot-spot' detection devices along perimeter (aerial or hand-held).

- Light fuels:

- cold-trail areas adjacent to unburned fuels.
- do minimal spading; restrict spading to hot areas near fireline only.
- use extensive cold-trailing to detect hot areas.

- Medium and heavy fuels:

- cold-trail charred logs near fireline; do minimal scraping or tool scarring.
- minimize bucking of logs to check for hot spots or extinguish fire: preferably roll the logs.
- return logs to original position after checking or ground is cool.
- refrain from making boneyards: burned/partially burned fuels that were moved should be arranged in natural positions as much as possible.
- consider allowing larger logs near the fireline to bum out instead of bucking into manageable lengths. Use lever, etc., to move large logs.

- Aerial fuels-brush, small trees and limbs
 - remove or limb only those fuels which, if ignited, have potential to spread fire outside the fireline.
- Burning trees and snags
 - If possible allow burning trees/snags to burn themselves out or down. (Ensure adequate safety measures are implemented and communicated.)
 - identify hazard trees with either an observer, flagging, and/or glowsticks.
 - if burning trees/snags pose serious threat of spreading fire brands, extinguish fire with water or dirt. FELLING by chain saw will be last means--consider falling by blasting, if available.

CAMP SITES AND PERSONAL CONDUCT

- Use existing campsites if available.
- If existing campsites are not available, select campsites that are unlikely to be observed by visitors/users.
- Select impact-resistant sites such as rocky or sandy soils, or opening within heavy timber. Avoid camping in meadows, along streams or lake shores.
- Change camp location if ground vegetation in and around the camp shows signs of excessive use.
- Do minimal disturbance to land in preparing bedding and campfire sites. Do not clear vegetation or do trenching to create bedding sites.
- Toilet sites should be located a minimum of 200 feet from water sources. Holes should be dug 6-8 inches deep.
- Select alternate travel routes between camp and fire if trail becomes excessive.
- Evaluate coyote camps versus fixed camp site in sensitive areas.

RESTORATION OF FIRE SUPPRESSION ACTIVITIES

- Firelines

- after fire spread is secured, fill in deep and wide firelines, and cup trenches.
- waterbar, as necessary, to prevent erosion, or use woody material to act as sediment dams.
- ensure stumps from cut trees/large size brush are cut flush with ground.
- camouflage cut stumps, if possible.
- any trees or large size brush cut during fireline construction should be scattered to appear natural.

- Camps

- restore campsite to natural conditions as much as possible.
- scatter fireplace rocks, charcoal from fire; cover fire ring with soil; blend area with natural cover.
- pack out all garbage and unburnables.

- General

- remove all signs of human activity (plastic flagging, small pieces of aluminum foil, litter).
- restore helicopter landing sites.
- cover, fill in latrine sites.

SECTION 2 - USE OF WATER AND ADDITIVES

This section covers types of pumps, basic hydraulics, pump setups, hose lays, and tactical use of water and additives. This section is not intended to replace the Portable Pumps and Water Use, S-211 training course. Safety is a primary concern in any fireline job and will be discussed as it relates to water and additives.

Water is beneficial to firefighting because it cools through its heat absorbing capability. Flaming combustion occurs around 600 °F in woody fuels. By reducing the temperature of the air and the exposed surface of the fuels, combustion will be retarded or even stopped. This effect is best realized in fine fuels.

Second, water when properly applied can reduce the oxygen supply to the fire by smothering. A fine spray can saturate the air with water vapor, or a solid stream of water can block off the oxygen supply to the fire. If water is plentiful, you can literally drown a fire.

Third, water dampens fuels to make them less combustible. Wet fuels will not burn until liquid moisture has been driven out. It takes a great deal of heat energy to convert water in liquid form to water vapor.

Whether water is abundant or scarce on your fire, it can play an important role in the suppression of the fire. Its availability will certainly affect how well you manage its use.

TYPES OF PUMPS

It's important to understand the differences between the two types of pumps available, their capabilities and limitations, and when to use each. There are two basic types of pumps--centrifugal and positive displacement. The centrifugal pump has a more or less open chamber that contains an impeller to move water (see Figure 1).

Figure 1 – Centrifugal Pump

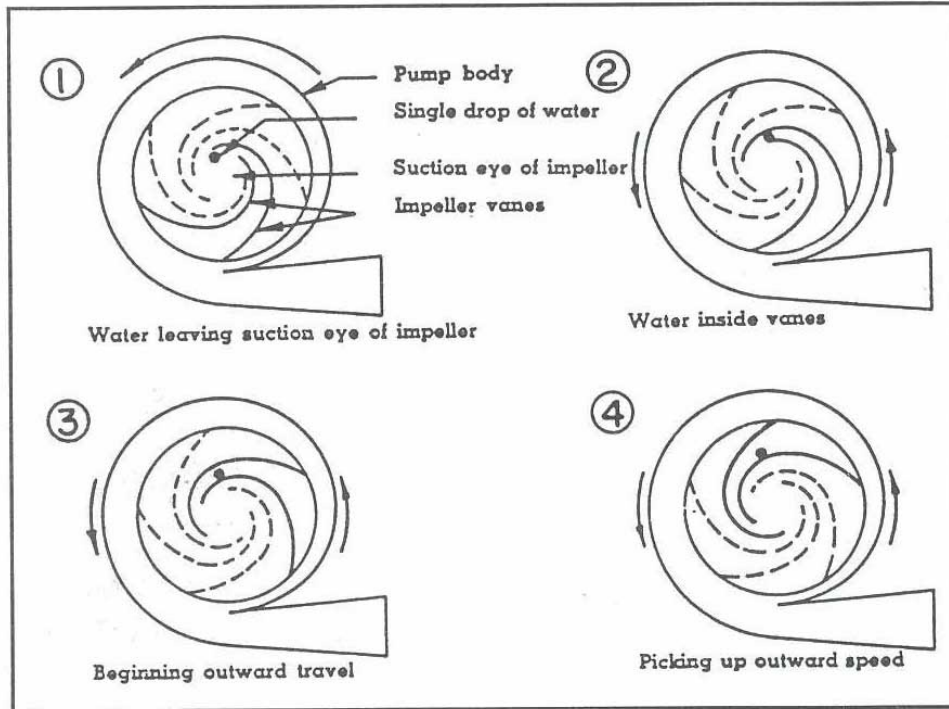

The positive displacement pump uses gears or pistons to do the same job (see Figure 2).

Figure 2 – Rotary Gear Positive Displacement Pump

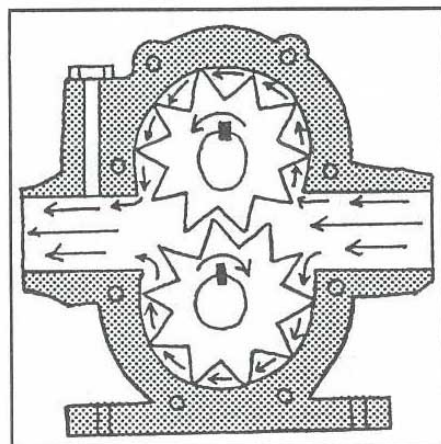

Although the results can be the same at the nozzle, you should realize there are advantages and disadvantages to using either type of pump.

Positive Displacement Pump Advantages:

- Does not usually require priming.
- Will draft water higher than a centrifugal pump - 15' to 20'.
- Does not require a foot valve on suction hose.

Positive Displacement Pump Disadvantages:

- Water must be free from sand and grit.
- Pump must be shut down when nozzle is off unless there is a pressure relief valve in line.
- Pumps cannot be started when there is head pressure on them, i.e., an uphill hose lay full of water.
- Almost always has to be returned to shop for maintenance or repairs.

Centrifugal Pump Advantages:

- Water does not need to be clean.
- Less maintenance cost. Can sometimes be repaired in the field.
- Nozzle can be shut off for a short period of time while pump is running.
- Pump can be started with head pressure.
- A pressure relief valve is not required, but is highly recommended.
- Pressure and volume can be changed by adjusting the speed of the pump motor.

Centrifugal Pump Disadvantages:

- Requires priming.
- Cannot draft water as high as a rotary pump.
- Should have a foot valve with the suction strainer.

Each type of pump is better adapted to certain jobs than the other. The high pressure positive displacement pump may be found on engines. They use shorter hose lines but have higher pressures at the nozzle. Centrifugal pumps are better

adapted for moving large volumes of water where lower pressures can be tolerated. This is the practice on most wildland fires where hose lays are commonly used.

If a primed pump is not able to lift water, or its performance is poor, there are three things you should consider to improve its performance. Three ways to improve the pump's suction capabilities are:

1. Locate the pump at or near water level.
2. Decrease the length of the suction hose. This usually means placing the pump close to the water source.
3. Tighten fittings.

HYDRAULICS

It's important to understand the hydraulic forces that influence the performance of pumps and hose lay systems. These forces are: suction or lift, head or back pressure, friction loss, and nozzle pressure.

The first force encountered in any pumping system is suction or lift at the input side of a pump. The maximum practical vertical lift capability from a water source to the pump is approximately 20 feet at sea level. Lift is reduced one foot for each 1,000 feet of rise in elevation above sea level. The more lift or suction required, the less efficient the pump will be on the discharge side. This is why a pump should be set up as close as possible to the water source to reduce the suction or lift (see Figure 3).

Figure 3 – Set Up Pump Close To Water Supply



The second hydraulic force is head (H) or back pressure. This is the pressure generated by the weight of water in a vertical column, such as the hose above or below a pump. When converted to pressure, it will equal approximately one pound per square inch (psi) for each two feet of vertical rise (see Figure 4). A hose line with a 200 foot vertical rise will exert 100 psi of head pressure. Without considering friction loss or nozzle pressure it will take a pump pressure of 100 psi to lift the water 200 feet in elevation. Head pressure is the primary force which prevents pumping water high vertical distances uphill.

The reverse is also true for head pressure. One psi of pressure will be gained for each two feet loss in elevation. A hose line with a 200 foot vertical drop will gain 100 psi of pressure due to head pressure. Exercise caution when pumping downhill because more pressure can be obtained than a hose can withstand or there may be more nozzle pressure than a nozzle person can safely handle.

Figure 4 – Head or Back Pressure

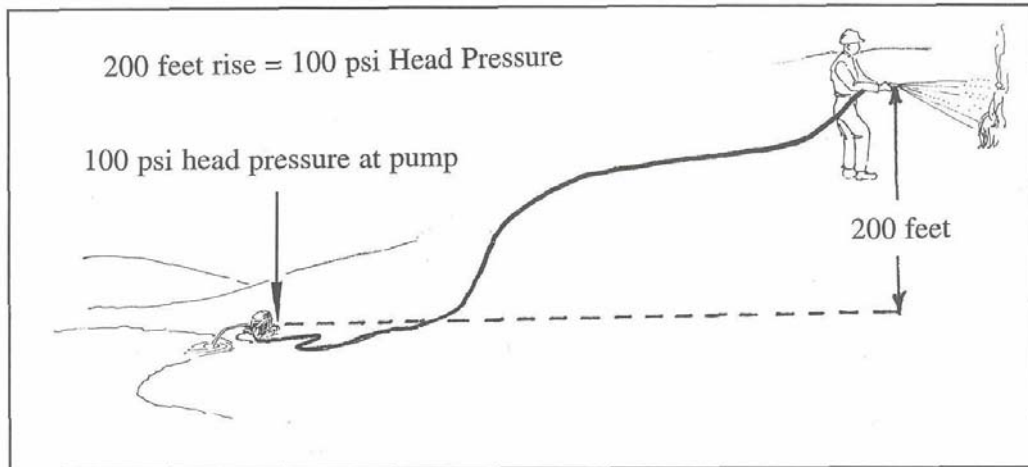

The third hydraulic force affecting a hose lay system is friction loss (FL). Friction, anywhere in the system, will reduce pressure. The amount of friction and pressure loss due to the hose depends on the diameter of the hose, its length, its inside texture, and the loss through nozzles and other hose lay appliances. Lined hose has a layer of rubber inside the collapsible fabric exterior. Friction loss through lined hose is considerably less than through unlined hose. Figure 5 shows the eddy effect of water flowing through a hose. The water flowing on the outer edges is slowed down (friction loss) due to the loss of energy caused while rubbing against the lining of the hose.

Figure 5 – Friction Loss In Hose

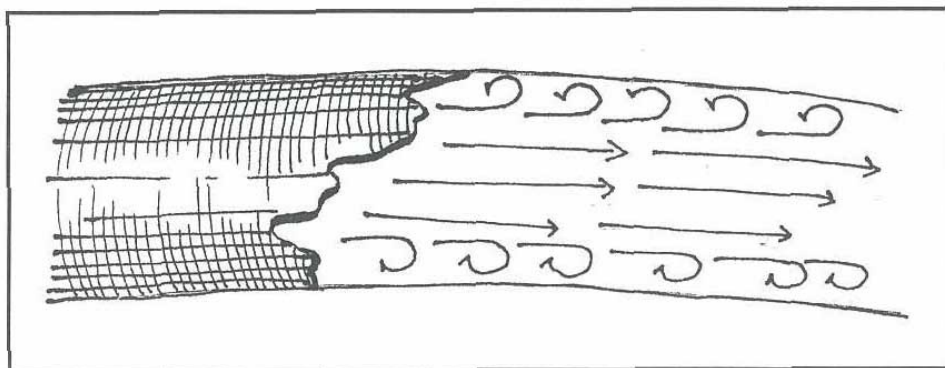

A drop in pressure will occur when a fitting (appliance) is added to a hose lay. This pressure change is affected by the following variables: fitting size, fitting bends, design, condition, and flow rate. This friction loss should be added in hose lays when determining friction loss.

Add five psi pressure loss due to friction for each appliance (gated wye, Siamese, tee, water thief, etc.) used in the hose lay.

The fourth force to be considered is nozzle pressure (NP). Nozzle pressure depends on the pressure of water to the nozzle and the size of the orifice in the nozzle. A smaller orifice will reduce volume, but increase nozzle pressure. The length of a straight stream can be increased by using a smaller nozzle orifice. However, this gain in pressure always results in less volume in the water stream.

The effective nozzle pressure for firefighting purposes depends on the specific nozzle used. Each is designed for more efficient use at a certain pressure. However, nozzles can be divided into two categories for basic hydraulics and pump pressure determination for wildland firefighting.

1. Straight streams, effective working pressure 50 psi.
2. Fog nozzles, effective working pressure 100 psi.

The only exception is the "Forester" nozzle which has an effective working pressure of 50 psi.

Each of the four hydraulic forces has an effect on the delivery of water to the fireline, some positive, some negative. How can you be sure that your hose lay system will deliver water to the fireline and with enough nozzle pressure to be effective? Of course, one way is to set it up and try it out. A better way is to perform a few simple calculations which will tell you whether or not it will do the job before you set it up.

The standard hydraulic equation for determining pump pressure is as follows:

PP = NP + or - H + FL + A where:

PP = Pump pressure at the discharge side of the pump.

NP = Nozzle pressure which is the pressure delivered to the nozzle.

H = Head. Add (+) if pumping uphill and subtract (-) if pumping downhill.

FL = Friction loss. The smaller the hose the greater the friction loss and the larger the hose the lower the friction loss.

A = Number of appliances used in the hose lay such as in-line T's, gated Wye's, etc. Each appliance increases friction loss and decreases nozzle pressure by about five psi. **DO NOT COUNT THE NOZZLES OR HOSE CONNECTIONS AS APPLIANCES.**

A drawback of using this equation is you must: 1) know the nozzle bore size, 2) use a Nozzle Discharge and Friction Loss Calculator or some other method to determine hose flow rate in gallons per minute and 3) apply the determined flow rate to a table for different size and types of hose to determine friction loss per 100 foot section of hose.

Tables 1 through 4 display the necessary pump pressure to achieve 50 and 100 psi nozzle pressure for 1 and 1 1/2 inch hose. However, remember nozzle pressure will be reduced approximately five psi for each appliance used in the hose lay.

Table 1 – Pump Pressure for 50 psi Nozzle Pressure (1-inch hose)

Length Hose in feet	Nozzle Above Pump in feet	<u>Tip size in Inchs</u>				
		1/8	3/16	1/4	5/16	3/8
100	0	51	52	55	62	75
	100	94	95	98	105	118
300	0	52	56	65	86	121
	100	95	99	108	129	164
	200	139	143	152	173	208
500	0	53	60	75	110	167
	100	96	103	118	153	210
	200	140	147	162	197	254
	300	183	190	205	240	297
1000	0	56	70	110	170	282
	100	99	113	153	213	325
	200	143	157	197	257	369
	300	186	200	240	300	
	400	229	243	283	343	
	500	273	287	327	387	
	600	316	330	370		
Discharge (GPM)		3	7	12	19	28
PSI Loss/100 ft.		0.3	1.8	4.7	11.0	23.0

Table 2 – Pump Pressure for 50 psi Nozzle Pressure (1 1/2-inch hose)

Length Hose in feet	Nozzle Above Pump in feet	Tip Size in Inchs				
		1/8	3/16	1/4	5/16	3/8
100	0	51	51	51	52	53
	100	94	94	94	95	96
300	0	51	52	53	56	60
	100	94	95	96	99	103
	200	138	139	140	143	147
500	0	51	53	55	60	66
	100	94	96	98	103	109
	200	138	140	142	147	153
	300	181	183	185	190	196
1000	0	51	55	59	68	82
	200	138	142	146	155	169
	400	224	228	232	241	255
	600	311	315	319	328	342
2000	0	52	59	67	84	114
	200	139	146	155	171	201
	400	225	232	241	257	287
	600	312	319	328	344	374
	800	298	405			
3000	0	53	64	75	100	146
	200	140	151	162	187	283
	400	226	237	248	273	319
	600	313	324	335	360	
	700	356	367	378	403	
Discharge (GPM)		3	7	12	19	28
PSI Loss/100 ft.		< 0.1	< 0.1	0.1	1.5	3.1

Table 3 – Pump Pressure for 100 psi Nozzle Pressure (1-inch hose)

Length hose (ft.)	Nozzle above pump (ft.)	Tip orifice size (inch)					
		1/8	3/16	1/4	5/16	3/8	1/2
100	0	101	103	109	118	135	200
	100	141	146	152	161	178	243
200	0	101	106	118	136	170	300
	100	144	149	161	179	213	343
300	0	102	109	127	154	205	400
	100	145	152	170	197	248	443
	200	189	196	214	241	292	487
400	0	103	112	136	172	240	500
	100	146	155	179	215	283	543
	200	190	199	223	259	327	587
	300	233	242	266	302	370	630
500	0	103	115	145	190	275	600
	100	146	158	188	233	318	643
	200	190	202	232	277	362	687
	300	233	245	275	320	405	730
1,000	0	107	131	190	280	450	
	100	150	174	233	323	493	
	200	194	218	277	267	537	
	300	237	261	320	410	580	
	400	281	305	364	454	624	
	500	324	348	407	497	667	
	600	368	392	451	541	711	
Discharge (gpm)		4.7	10.5	18.7	28.7	42.1	74.7
Psi loss/100 ft.		0.7	3.1	9.0	18.0	35	100

Table 4 – Pump Pressure for 100 psi Nozzle Pressure (1 1/2-inch hose)

Length hose (ft.)	Nozzle above pump (ft.)	Tip orifice size (inch)					
		1/8	3/16	1/4	5/16	3/8	1/2
100	0	101	101	102	103	106	117
	100	144	144	145	146	149	160
200	0	101	102	103	107	112	134
	100	144	145	146	150	155	177
300	0	101	103	105	110	118	151
	100	144	144	148	153	161	194
	200	188	190	192	197	205	238
400	0	101	102	106	113	124	168
	100	144	145	149	156	167	211
	200	188	189	193	200	211	255
	300	231	232	236	243	254	298
500	0	101	103	108	117	130	185
	100	144	146	151	160	173	228
	200	188	190	195	204	217	272
	300	231	233	238	247	260	315
1,000	0	101	105	115	133	160	270
	100	144	148	158	176	203	313
	200	188	192	202	220	247	357
	300	231	235	245	263	290	400
	400	275	275	289	307	334	444
	500	318	322	332	350	317	487
2,000	0	102	110	130	166	220	410
	100	145	153	173	209	263	433
	200	189	197	217	253	307	527
	300	232	240	260	296	350	570
	400	276	284	304	340	394	614
	500	319	327	347	383	437	657
	600	363	371	391	427	481	701
	700	406	414	434	470	524	744
3,000	0	103	115	145	199	280	610
	100	143	158	188	242	323	653
	200	190	202	232	286	367	697
	300	233	245	275	329	410	740
	400	277	289	319	373	454	784
	500	320	332	362	416	497	827
	600	364	376	406	460	541	871
	700	407	419	449	503	584	
800	451	463	493	547	628		
Discharge (gpm)		4.7	10.5	18.7	28.7	42.1	74.7
Psi loss/100 ft.		0.1	0.5	1.5	3.3	6.0	17

Caution---Pump pressures over 450 psi exceed the normal working pressure of Single Jacket, Cotton-Synthetic Lined Hose (USDA Forest Service Specification 5100-186).

Following is an example to determine pump pressure from the previous tables.

What pump pressure will be required to deliver a nozzle pressure of 50 psi using a 318-inch nozzle attached to 1000 feet of 1 1/2-inch lined hose? The rise in elevation is 200 feet. There are three in-line T's in the hose lay.

From Table 2-Pump Pressure for 50 psi Nozzle Pressure (1 1/2-inch hose), the pump pressure for the 1000 foot hose lay with a 200 foot rise in elevation using a 318-inch nozzle is 169 psi. Add 15 psi for the three in-line T's and the required pump pressure is 184 psi.

There may be times when some interpolation is needed to use the tables, but the main thing to remember is to use a little common sense with hydraulic calculations. Remember, the purpose of hydraulic calculations is to give you some idea if the proposed hose lay system will work. Table 5 gives the operating psi and maximum lift for some of the common pumps used in wildland firefighting.

Table 5 – Expected Output of Commonly Used Portable Pumps*

Pump Type	Operating psi	Maximum lift (ft)
Waterous (Floto Pump)	150	200
Gorman Rupp (621/2)	190	280
Mark 3	250	400

*All calculations were made using 1 1/2 inch hose and Forester Nozzle with 3/16" tip and a nozzle pressure of 50 psi.

From the above example, 184 psi pump pressure is required to produce 50 psi nozzle pressure with a 318" tip attached to a 1,000 foot hose lay with a three inline T's and a 200 foot rise in elevation. From Table 5 both the Gorman Rupp and Mark 3 will produce enough psi to accomplish this setup.

SERIES, PARALLEL AND STAGED PUMPING

If a single pump is inadequate to supply enough pressure or volume of water, an alternative is to use a series, parallel, or staged pumping setup. This concept applies to all types of pumps. It is extremely useful and important that you understand the various effects of these methods.

With series pumping, two pumps are connected "in-line." Water is pumped by the first pump directly into the second pump. The hydraulic effect is to **increase pressure** (see Figure 6).

Figure 6 – Series Pumping

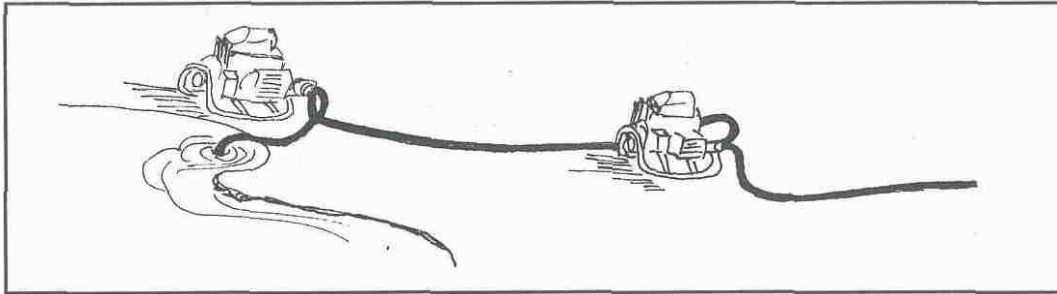

Pumps in series will almost **double the pressure**. The volume will be limited to that of the first pump. This assumes that both pumps have equal capabilities in term of pressure and volume. In field applications, the pressure will be slightly less due to hydraulics.

Example: One Mark 3 pump will produce a flow of 12 gpm and 275 psi. By adding another Mark 3 pump in series, the combination will still only produce 12 gpm. However, the theoretical pressure will be 550 psi, while in field applications the pressure will be closer to 450 psi.

The Water Handling Equipment Guide, NFES No. 1275, available through the Publication Management System provides performance and output capabilities of many of the portable pumps used in wildland firefighting.

Series pumping can produce more pressure than the hose can withstand so be careful. It's a good idea to use one or two sections of lined hose at the beginning of a hose lay when setting up pumps in series.

Pumps with different capabilities may be connected in series. Usually, the pump with the highest capability is placed closest to the water source. Then the lower capability pump is placed "in-line." The limiting factor is the ability of the first pump to supply enough water to the second pump. The following situations illustrate this principle.

The first step in series pumping is planning the system. This should include:

1. Required water needs. This should be based on the desired nozzle pressure and volume needed at the application. In other words, you need to know how much water is needed in order to supply it.
2. Location and type of water sources. The water source should have enough water to supply the users. The type refers to streams, ponds, portable tanks, etc.
3. Personnel requirements. Determine how many operators will be needed to ensure the pumps can be adequately monitored and operated. Establish communication procedures between the pump operators and the users.
4. Pump, hose, and fitting requirements. Determine how many pumps, hose, etc., will be needed to supply the desired volume and pressure at the end of the hose lay. In many field situations, the hose and fittings available will determine how the pumps are arranged. In some cases, it may not be possible to meet the water needs with the available equipment.

With parallel pumping two pumps are connected "side by side." Water flows from each independent pump into a single hose lay. The hydraulic effect is to nearly double water volume (see Figure 7). Ideally, pumps should have equal capabilities in terms of pressure and volume.

Figure 7 – Parallel Pumping

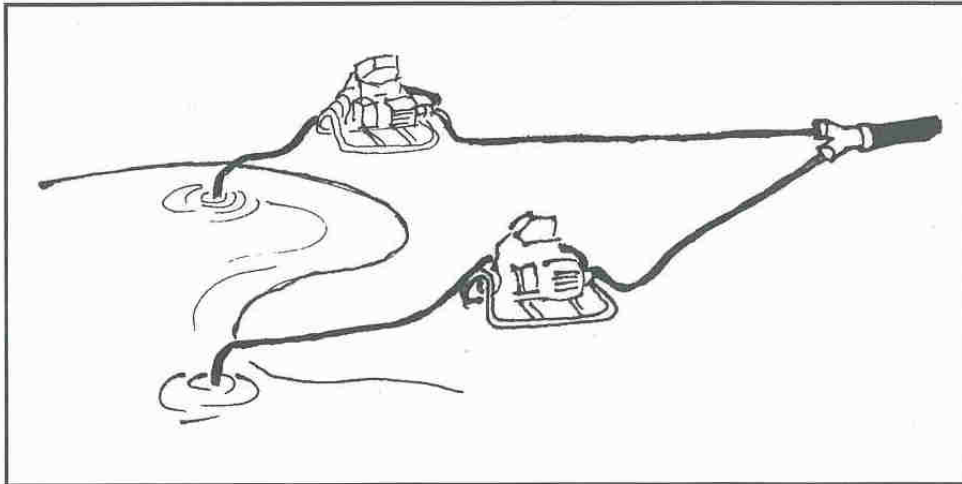

Pumps with unequal capabilities may be connected in parallel. However, pressure and volume will be limited by the capability of the smallest pump. In field applications, the actual volume produced will be less than double primarily due to friction loss.

With staged pumping the pumps are not directly connected, but are operated independently from each other (see Figure 8). The hydraulic effect is equal to the capability of each pump.

Figure 8 – Staged Pumping

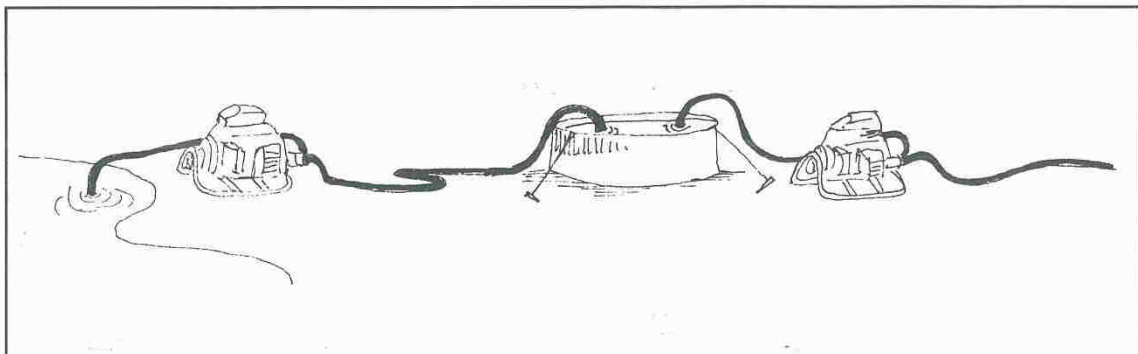

Staged pumping moves water to a temporary storage reservoir which is then relayed by a second pump. The second pump can then supply the water directly to the fireline or supply another reservoir. An advantage of staged pumping over series is that the water supply is less likely to be interrupted if a pump must be shut down for repairs or servicing.

There is no limit to the number of times water can be relayed. Staged pumping is only limited by the capability of any of the pumps.

Pumps may also be connected in any combination of parallel or series to supply temporary reservoirs depending on the desired volume and pressure.

It is possible to have several combinations of series, parallel, and staged pumping arrangements all at the same time to supply water. It takes skill and knowledge to make the pump combinations effective. The more complex system that is designed, the more planning is needed to ensure the system will meet the fire's needs.

Remember: **KEEP IT SIMPLE.**

HOSE LAYS

Once the firefighter is familiar with how to set up, operate, and maintain a portable pump, they then must get the water to the fire in an efficient and safe manner. This is accomplished by flowing water through the hose, fittings, and nozzles. There are numerous ingenious methods for dispensing hose and fittings to accomplish this. Here we will discuss the types of hose lays, not the methods used to lay the hose out.

The two types of hose lays are simple and progressive. Both types of hose lay may use either 1 inch or 1 1/2 inch hose of whatever type construction that is preferred.

Simple - one that comes straight off the pump and goes directly to the nozzle with no junctions in between.

Figure 9 – Simple Hose Lay

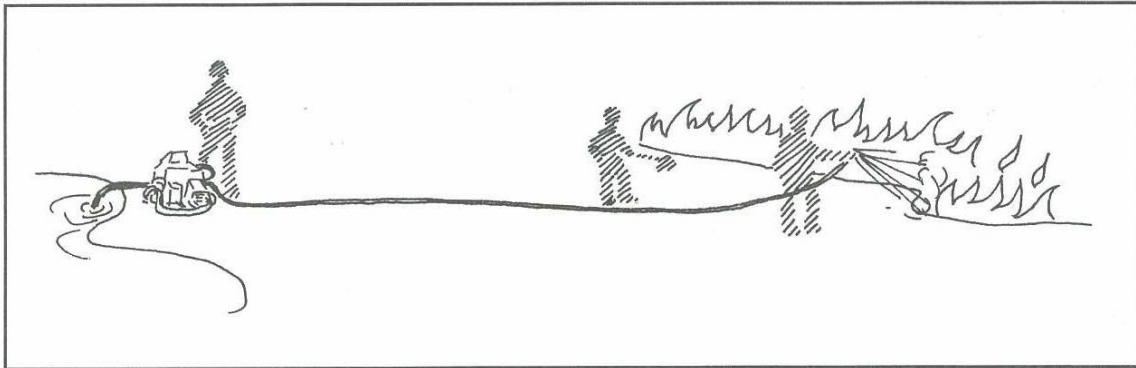

A simple hose lay is easily installed and can vary in length as needed. This type of hose lay does not have a lot of friction loss due to additional fittings, which is an advantage. The key disadvantage of the simple hose lay is that the water flow must be stopped before it can be extended by adding a length of hose. There also are no provisions for safety should the fire flare up behind the nozzle operator. A simple hose lay is more difficult to use in mopup as you must either revise the installation process or pull large amounts of hose.

Progressive - one that comes from a pump source to the fire which has a series of lateral junctions in place between the pump and lead nozzle.

Figure 10 – Progressive Hose Lay

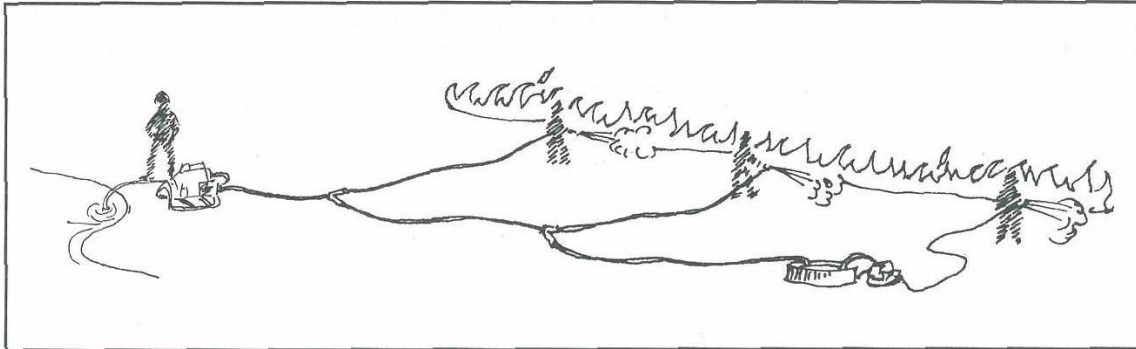

A progressive hose lay is one that incorporates a series of lateral lines off of a main trunk line. The progressive hose lay has several advantages over the simple hose lay in that it provides for a continuous attack on a fire without risking shutting down the hose lay to extend its reach. The progressive hose lay provides a security margin for the lead nozzle operator in that there is a charged or easily charged lateral line left behind should there be a flare up. It also can provide for multiple attack lines on spot fires across the control line. A progressive hose lay does create a higher friction loss in your hose lay due to the increased numbers of fittings (approximately five psi each). A progressive hose lay may be slower to install, but is inherently safer for direct attack and much more efficient in mopup.

To install a progressive hose lay (see Figure 11) a crew first stretches a trunk line of 1 1/2 inch hose from the pump to the fire as a simple hose lay. Once they reach the fire, they install a gated wye and proceed 100 to 150 feet with the trunk line to install another gated wye, which has a 1 1/2 inch to 1 inch reducer on one side (towards the fire) and attach 100 feet of 1 inch hose with the preferred nozzle. One person can then operate this nozzle to attack the fire as another person stretches the next section of the trunk line which is attached to the remaining side of the gated wye. Once the trunk line is stretched and the second lateral gated wye is in place the first nozzle operator then charges the trunk line and returns for more hose once the second lateral attack line is flowing water. This process is repeated until the fire is contained or the pump has reached its capacity.

A progressive hose lay is very efficient when mopup time arrives. A progressive hose lay from a Mark 3 pump can easily supply three to five nozzles depending on friction loss and required head pressure. This can efficiently keep a 20 person crew busy. A progressive hose lay provides numerous opportunities for lateral lines to speed up mopup and prevent having to move 1 1/2 inch trunk lines.

Figure 11 – Steps of a Progressive Hose Lay

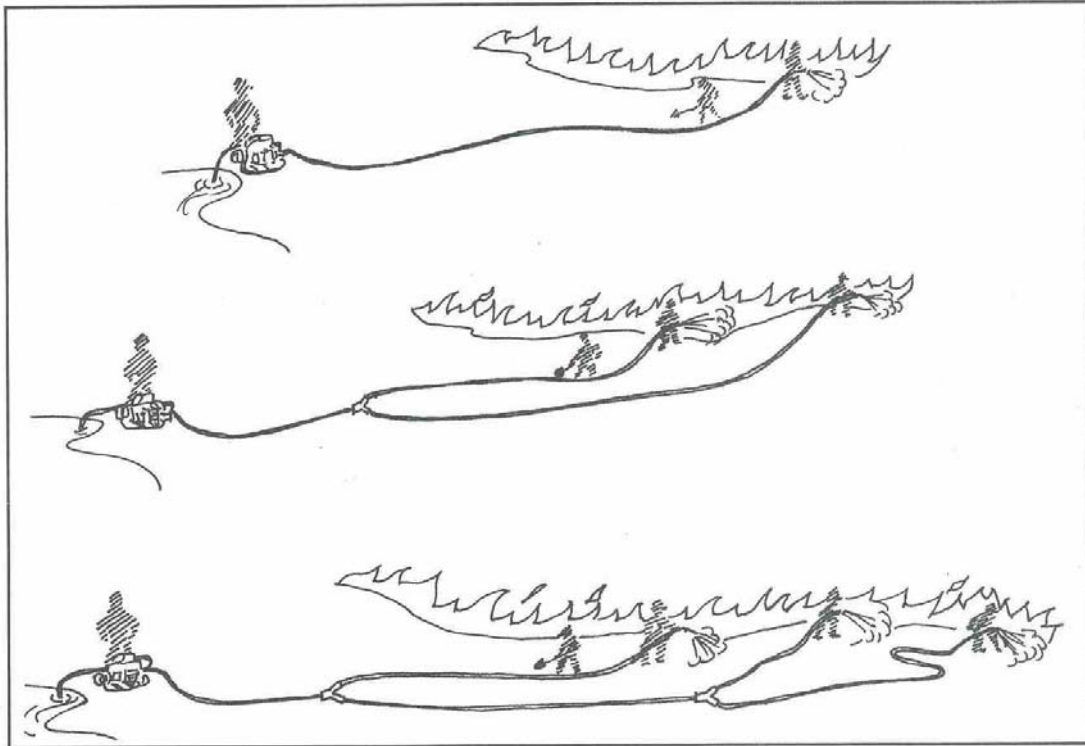

Hose Lay Safety

Avoid using hardlines (or any other 1-inch lines) on extended hose lays. Friction loss is too great and there may be an inadequate volume of water to protect the nozzle operator and effectively extend the line as the fire progresses.

Combination nozzles providing a fog pattern will add an extra measure of safety, as long as adequate water is available at the nozzle.

Always provide communications between the nozzle operator and the pump operator and have an anchor point for the hose lay.

MOPUP

One effective use of water is for mopup. Where and how to use the available water supply is always a concern to fireline supervisors. Here are some priorities usually set during mopup:

1. Put out any spot fires outside the fireline.
2. Extinguish any hot spots immediately inside the fireline that could possibly threaten the line.
3. Put out hot spots further inside the burn, but adjacent to unburned islands of hazardous fuels.
4. Mop up all smokes inside the line for a reasonably safe distance.
5. Patrol and/or mop up the entire burn area until the fire is dead out.
6. On peat fires, peat nozzles or flooding using irrigation pumps are effective methods of mopup.
7. On deep burning ground fires, moderate to high volume sprinklers are effective methods of mopup.

Water can be used very sparingly but effectively when hand tools are used to expose burning fuels and mix soil with fire. Wetting agents and foam will greatly help water penetrate into fuels and hot spots.

Mopup is normally a slow, tedious job. Water does not necessarily reduce the amount of work required, but it can save you time. Some firefighters attempt to drown out fire, but find this usually doesn't work. Water does not readily penetrate deep organic layers and can actually insulate hot spots under the ground. These hot spots can come to the surface later.

The most effective procedure is to break up and scatter burning fuels, then cool them down with water. Dig, scrape, and scatter-hard work, but necessary to insure that the fire is out and safe to leave.

High water volumes and pressures at the nozzle generally are not needed during mopup and often cause a hazard from steam and blowing debris and ash. Gloves and goggles should be worn when doing mopup with water. A few squirts from a backpack pump can easily cool down hot embers. Mopup kits which contain a series of garden hoses as laterals are excellent for mopping up large sections of

fireline. Remember, a combination of water and hand tool work is a winning team for a speedy mopup.

TACTICAL USE OF WATER

From your fire behavior training, you have studied the fire triangle as a model for the process known as combustion.

Figure 12 – Fire Triangle

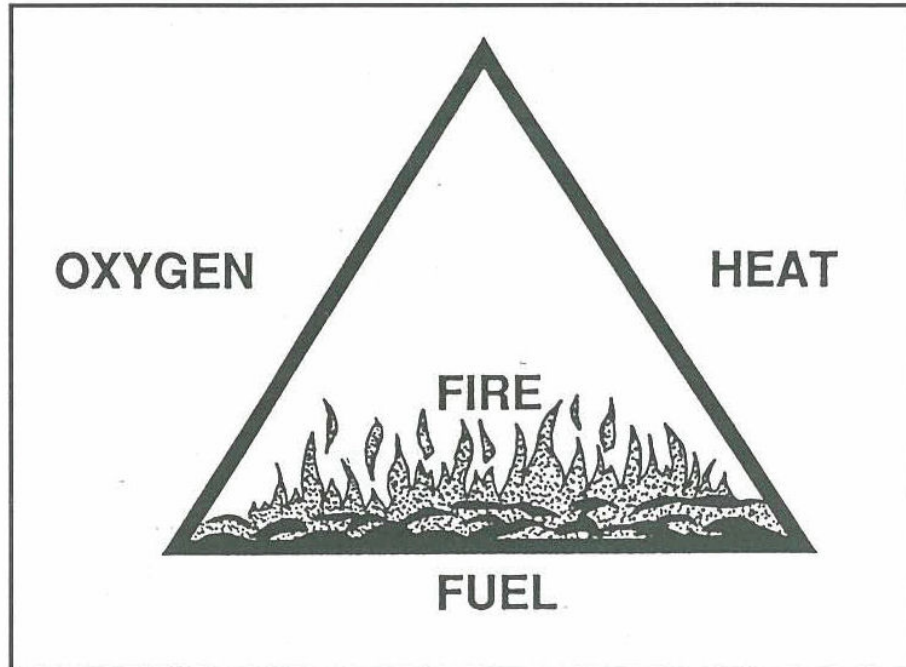

The basic principle of fire suppression is to remove one or more of the three essential components of the fire triangle. This may be accomplished through the removal of the fuels; by reducing the temperature of the burning fuels below their ignition point, or by excluding oxygen. Equipment used to apply water carries out a dual function by excluding the amount of available oxygen and in reducing the temperature of the fuels.

The water triangle (see Figure 13) serves as a useful model to explain how water, when applied in the **right amount, right form and right place** can increase your success in extinguishing flame and burning fuels.

Figure 13 – Water Triangle

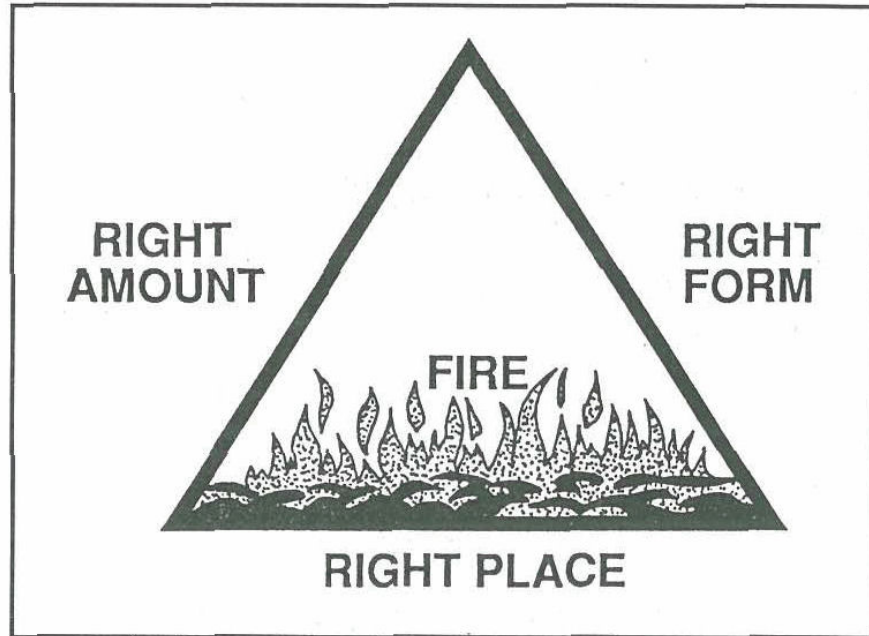

First, let's look at how you can increase your effectiveness through the application of water in the **right place** on the fire.

Figure 14 – Apply Water at Right Place

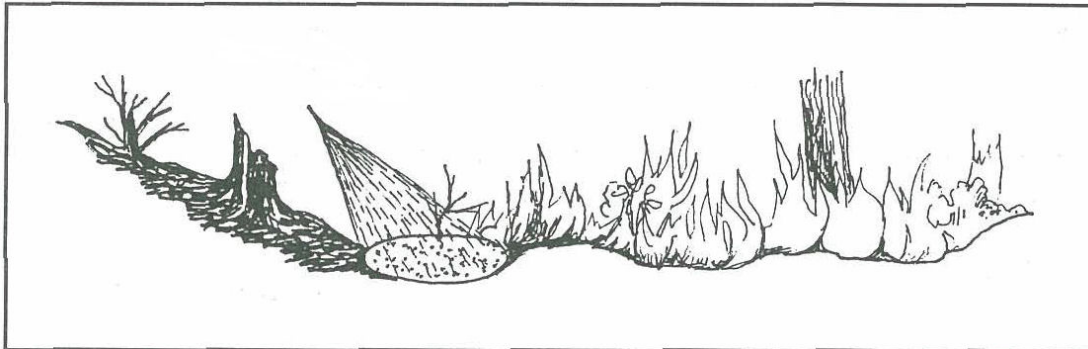

If water is applied in the right place, the temperature of the burning fuel will be reduced below its kindling point. To accomplish this, the stream of water should be directed at the base of the flame, where the heating of the fuel and its conversion to a flammable vapor is taking place. The rapid lowering of fuel temperature effectively excludes the heat component of the fire triangle and flaming combustion is extinguished. This is particularly effective where flaming combustion involves fuels burning at or above the surface.

Where the fire is burning in the organic fuels below the surface, the same principle applies. You must get the water down to the source of the heat where combustion is taking place to be effective. Water applied elsewhere is a wasted effort.

This concept of right place applies to fires under all circumstances.

Water in the **right form**, is the next segment in the water triangle.

Nozzles allow you to form and direct a stream of water under pressure at the fire (see Figure 15). The nozzle and the skill of the operator at the point of application determine the degree of success which is achieved. Water can be highly effective or largely wasteful depending on which nozzle is selected and how it is used.

Figure 15 – Nozzle Types

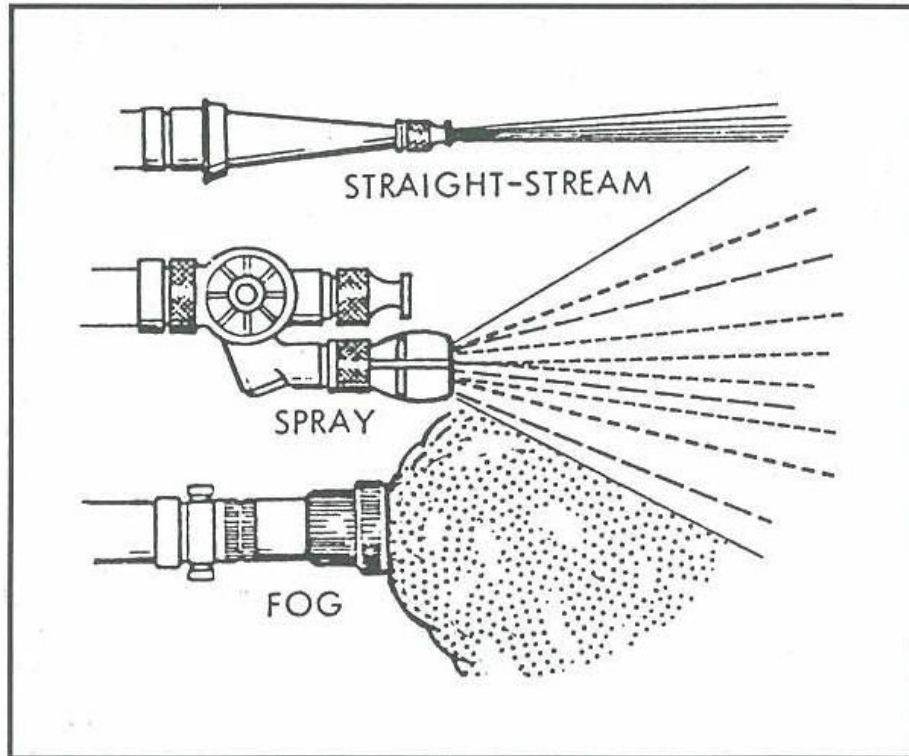

While there is a large variety of nozzles to choose from, the types most often used for wildland fire applications can be broadly grouped as:

1. Plain: Plain screw on tips, either straight stream or spray pattern.
2. Select Tip Combination Shutoff: Multiple tip nozzle such as the "Forester" six-shooter.
3. Single Tip Shutoff: Straight stream or spray pattern with shutoff.
4. Twin Tip Combination Shutoff: Combination straight stream and fog pattern with shut off.
5. Adjustable Combination: Adjustable sequence from shut off to straight stream or spray pattern.

The various types of nozzles offer you the ability to make your selection based on rate of delivery (gallons per minute), pressure requirements and a variety of water patterns, from solid streams to spray patterns to a fine fog.

Combination nozzles that provide both straight stream and spray patterns are usually required in most wildland fire applications because of the need to vary the water stream to the conditions encountered along the fireline. To be effective with water, the nozzle operator must adjust water streams to the job at hand.

Solid water streams provided from the nozzles which flow water as a single straight stream are used where the ability to reach, or distance, is the key aspect in getting water onto the fire. Fire burning high up in a snag may require the additional reach which you can obtain from a straight stream. Where the fire is burning too intensely for the nozzle operator to work close to the fire's edge, the straight stream is used to cool the fire from a distance so that closer work can be performed later. In some situations where strong winds prevent you from directing spray patterns accurately, it may be necessary to switch to a straight stream to get the water into the right place. Straight streams can also be effective where penetration into matted grass, needles and duff is necessary.

While straight streams satisfy the requirement for reach and distance, they tend to use a higher volume of water than other methods. This is largely due to the delivery of water as a solid stream, which affects only a narrow piece of the fire area treated. These types of nozzles usually operate effectively at 50 p.s.i., though higher pressures may be needed when distance or surface penetration is needed.

Spray and fog patterns offer the nozzle operator more effective application of water because of the small droplet size. These types of patterns absorb more heat and treat a greater burning fuel surface area with a smaller volume of water. For these reasons, spray and fog patterns are used extensively for close work along the fireline and where protection from intense heat is needed for the nozzle operator.

The final component of the water triangle is water in the **right amount** (see Figure 16).

Figure 16 – Apply Water in Right Amount

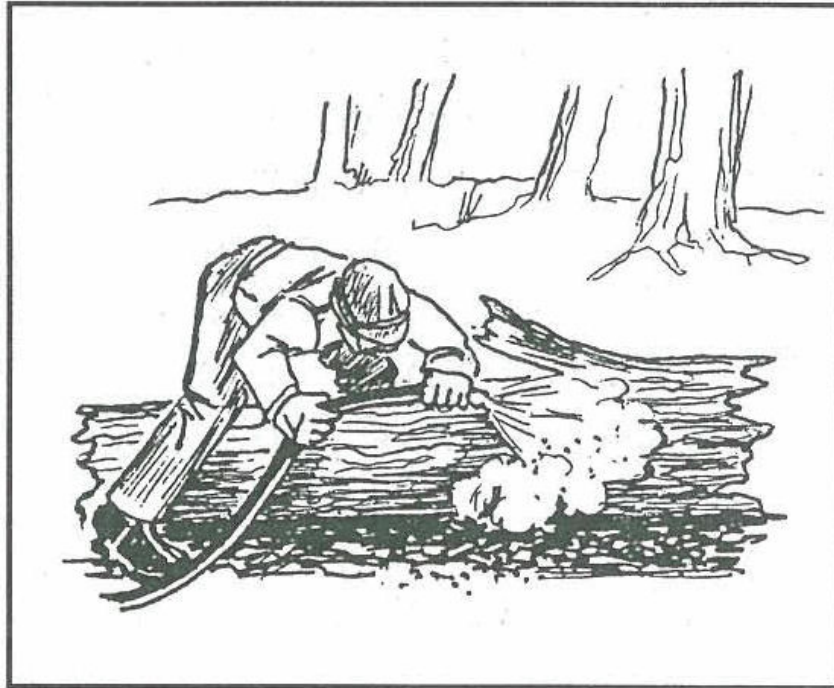

When you think about the right amount of water, it is important to realize that a small amount of water is capable of extinguishing a lot of burning fuel. One of the ideas which is established early in your career as a firefighter, is that one volume of water is capable of extinguishing 300 volumes of burning fuel, if properly applied. Many nozzles are capable of producing a fine spray, which breaks the water stream into many droplets. Through the high heat absorbing capacity of water, many droplets can cool and extinguish many units of fire if applied to the right place and form.

In any given situation, the amount of water required to extinguish a fire will largely depend upon the fire intensity and the type of fuels burning. Generally, we can say that more fire intensity will take more water and less fire intensity will take less water.

Water Conservation

Whenever possible, add a surfactant to your water supply. Surfactants have an advantage over plain water whenever complete wetting is needed. They will speed up the wetting of the ground fuels and less water will be wasted through runoff from the fuel surface. Surfactants used to produce foam work by holding the water on the surface of the fuel.

Good communications should be established and maintained between the nozzle operator and the pump operator, by either radio or hand signals. The nozzle operator should always know how much water is available at the source, since this could make a difference in what type of action is taken on the fire. In turn, the nozzle operator should communicate whether the supply and delivery system is meeting the needs at the fire scene or not.

Personnel with hand tools should work closely with nozzle personnel. Mineral soil applied with skilled hand tool use can be effective to exclude oxygen, knock down flame and to cool burning embers leaving nozzle operators available to apply water where the greatest benefit can be attained. Where water is applied to extinguish flaming combustion and fuels are left in a glowing or smoldering state, have personnel with hand tools follow up by raking and mixing the treated fuels with mineral soil. The pulaski is an excellent tool for scraping and peeling heavy fuels, so that water can be applied directly to the source of heat. If a pump should fail, enough hand tools should be available to extinguish the fire with mineral soil.

Figure 17 – Handtools and Water

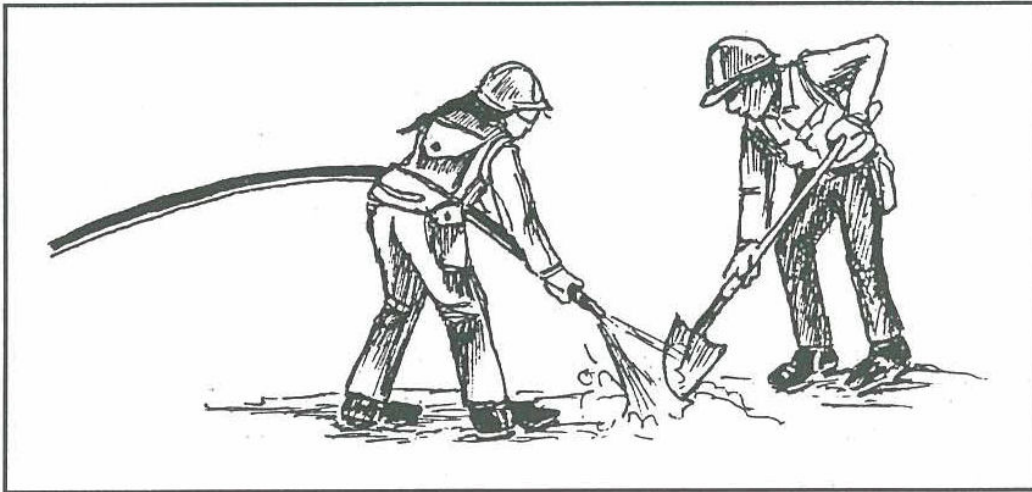

Know Your Equipment

A lot can be done to conserve water by knowing which fittings contribute to the effort, and assuring that they are used. There are four fittings which are commonly used to conserve water: low gallonage nozzles, the check and bleeder valve, the pressure relief valve and shut-offs. Let's take a look at each one of these to see how they contribute to the effort of water conservation.

First, by selecting the lowest gallon per minute nozzle(s) to safely do the job, you can, to a large extent, control the amount of water arriving at the fire. It doesn't make sense to select a 30 gallon per minute nozzle, when the same job can be safely accomplished by using a nozzle rated at 12 gallons per minute. Your knowledge of the gallon per minute rating of nozzles available to you is going to make a big difference in your contribution to water conservation.

The installation of the check and bleeder valve contributes to the water conservation effort by allowing the pump operator to circulate water back to its source while starting the pump against a head of water pressure. The check valve feature not only protects the pump from water flowing back against it when it is stopped, it also maintains the volume of water already in the hose lay system. This can be a substantial amount when you consider that each 100 foot length of 1 1/2 inch hose holds approximately 9 gallons of water and the same length of 1 inch hose holds about 4 gallons of water.

The main feature of the pressure relief valve is its sensitivity to pressure and its ability to relieve excessive pressure on the discharge side of the pump back to the water source. By presetting this valve to the desired working pressure, water under pressure which is not needed at the nozzle is then returned to the water source through a 1 inch hose at the valve. The ability to maintain constant pressure is an important feature for the protection of nozzle operators. Any sudden change in one line can cause a pressure surge on the other.

Shut-offs of various types represent the final water handling device used to conserve water. Hose clamps, in-line tees, gated valves and nozzles with shut-offs all allow you more control over maintaining water within the delivery system. By clamping off or shutting down gated valves, you can keep a broken hose from wasting water on cold ground. Nozzles with a shut-off allow you to move from one point of application to another, without wasting water where it isn't needed.

Role Of The Nozzle Operator

The nozzle and the skill of the operator at the point of application can determine the degree of success which is achieved. Water can be either highly effective or largely wasteful depending on which nozzle is selected and how it is used.

To be effective with a limited water supply, the nozzle operator must learn to master the use of the nozzle, the shut-off, the pressure and the method with which water is applied.

Nozzles vary in gallons per minute, pressure requirements and type of water streams produced. Your selection of the nozzle should be based on the lowest gallon per minute rating which will allow you to safely do the job. Whenever possible, select a nozzle which will offer you the versatility needed to do various tasks along the fireline without sacrificing high delivery rates or gallons per minute. Spending a few minutes with an experienced firefighter will get you started in the right direction.

Learn to adjust the nozzle pattern to match the water output to the fire intensity. As a general rule, we can say that more fire intensity will take more water and less fire intensity will take less water. Learn what types of fuel models and the fire intensity levels associated with them are attained during the average and worst conditions to help determine what works well.

Always apply water at the base of the burning flame.

Figure 18 – Apply Water at Base of Flame

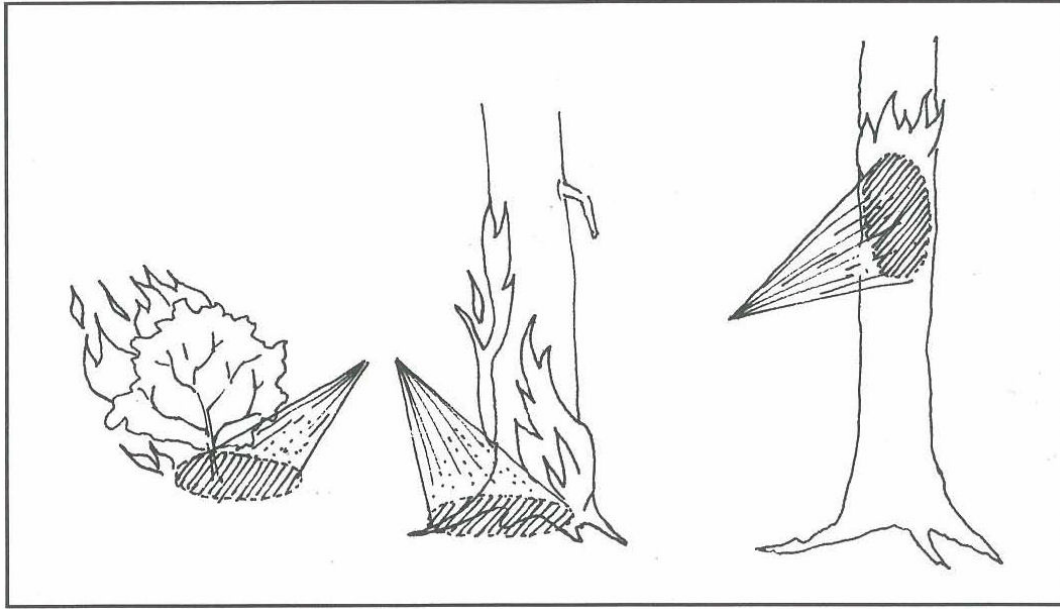

Straight streams should only be used to:

- Cool a hot fire, in order to get in closer.
- Knock fire out of snags or Gee tops, where distance and reach are important.
- Hit a dangerous hot spot ahead of you.

When it is necessary to use straight streams to cool a hot fire or hit a dangerous hot spot ahead of you, you can cool a greater volume of burning fuel by aiming your stream at the base of the hot spot and bouncing some of it off the ground in a fan shape.

Water can best be conserved by using spray and fog patterns to absorb more heat and cover a larger volume of burning fuel. Work the nozzle close to the fire whenever possible, you will have better accuracy and will achieve better penetration into fuels.

Learn the effects that pressure has on your nozzles. Some nozzles at high pressures deliver air and water on the fire which has the effect of fanning the

flames at the edge of the application instead of knocking them down. Straight stream nozzles usually operate effectively at 50 p.s.i. Spray and fog patterns usually require more pressure to break the stream of water up into a fine spray or fog. They usually require 100 p.s.i., though many will continue to develop good patterns with less pressure. Aspirating nozzles usually require pressures of more than 100 p.s.i. to achieve the desired results of air induced foam. Your best opportunity here is to practice with various combinations of nozzle types and openings under different pressures.

While you may need the full potential of the system during the early stages of the fire, you can usually reduce operating pressures after the initial actions are completed and increase your water use time with lower discharge rates. As a general rule, flow rates are reduced to 314, when nozzle pressure is reduced from 100 p.s.i. to 50 p.s.i. With good communications, pressures can be increased or decreased to meet your needs.

Technique Of Applying Water

Learn to develop an on-again, off-again technique of application. This method is used in all fire situations and should serve as the basis for your application of water. An essential feature of this type of application is a quick acting shut-off.

On the fireline, direct a small amount of your stream at the base of the burning fuels and then shut off your nozzle and prepare to move on working parallel to the fire edge. Watch the line already treated, if the fuel re-kindles, apply additional water in a short burst. The fuels treated are then mixed by personnel with hand tools and water is applied if needed. When moving from one hot spot to another, shut off your water at the nozzle. Water should be applied intermittently on specific areas of fire to gain the most from your water supply.

This technique of on-again, off-again is continued all around the perimeter of the fire until it is out. By applying the water parallel along the fireline, you will cover more fireline area and be less likely to leave fire behind you. Water applied intermittently gives you a better chance of applying the least amount of water necessary to do the job.

It takes practice and experience to use just enough water to do the job and then shut off the nozzle, so that you can move on. Practice will save you water and increase your skill with this technique.

Tactical Methods Of Application

Four tactics commonly used in the application of water are: **hot spotting, deluge, containment and exposure protection**. As you look at each one of these tactics of application, you should pay particular attention to how water is applied and what the objectives are.

Hot Spotting

The tactic of hot spotting is usually associated with direct attack. It is often the initial step in initial attack with emphasis on first priorities. The rule here is to attack the point where the fire is most likely to escape. This means giving first attention to cooling down the head of the fire and any hot spots along the fire edge which threaten to ignite new fuels. The objective is to slow down or to stop the spread until adequate help arrives. Water is applied intermittently, moving from one hot spot to another making them temporarily safe.

Emphasis may be given to hitting hot spots ahead of the main fire, or to cutting the fire off from making runs through dangerous fuels such as young trees, heavy brush, logging slash, or grassy fuels leading into heavier fuels. Flare-ups are knocked down and hot spots are cooled to a safe condition. As you can see, the key to hot spotting is the continual size-up of the fire and staying as mobile as possible.

Deluge

With the deluge method, water is applied in sufficient volume for quick and complete extinguishment of the fire. The entire burning area is treated with water. The objective is to rapidly and completely extinguish the fire with little, if any, other help. This method is usually associated with small fires, since the availability of an adequate water supply is a key factor here. The decision to use this tactic is usually based on where an agency may be experiencing multiple fires over a relatively small geographical area, or where the fire danger and lack of additional resources necessitate it. In this respect, the fire is quickly drenched, allowing equipment to be available for reassignment to another fire. It is also used where good judgment shows that the fire can be kept from spreading to threatened high values in the path of the fire.

Your experience and good judgment is the key to the use of this tactic. You should know how much water you have and how much fire you can extinguish; what pressures and discharge rates are necessary to extinguish the fire. The application of foam is very compatible with the tactic of deluge, due to its ability to effectively knock down flaming combustion and form a blanket over the fire which acts **as** a vapor barrier. The potential to use less water is very strong since fuels are coated and less water is wasted from running off the surface of the treated area.

As with hot spotting, work should always begin where the fire is most likely to escape. If you run out of water, follow up with hand tools working as close to your original plan as possible.

Containment

The containment method is a progressive, stop the spread of the fire strategy. Tactically, water may be applied in as large a volume as necessary to knock the fire down and stop its spread. This method is often used where it is not possible to perform work at the head of fire. Instead, application is started at the rear of the fire where the control action can be safely anchored to a road or a natural barrier. From here, water is applied and progressive hose lays are continued down either flank, or both flanks as close to the fire **as** possible until the fire is completely surrounded. The objective here is the containment of the fire, rather than the complete extinguishment, fuels within the fire perimeter are allowed to burn out or mopup progresses when containment is achieved.

Figure 19 – Containment Tactic

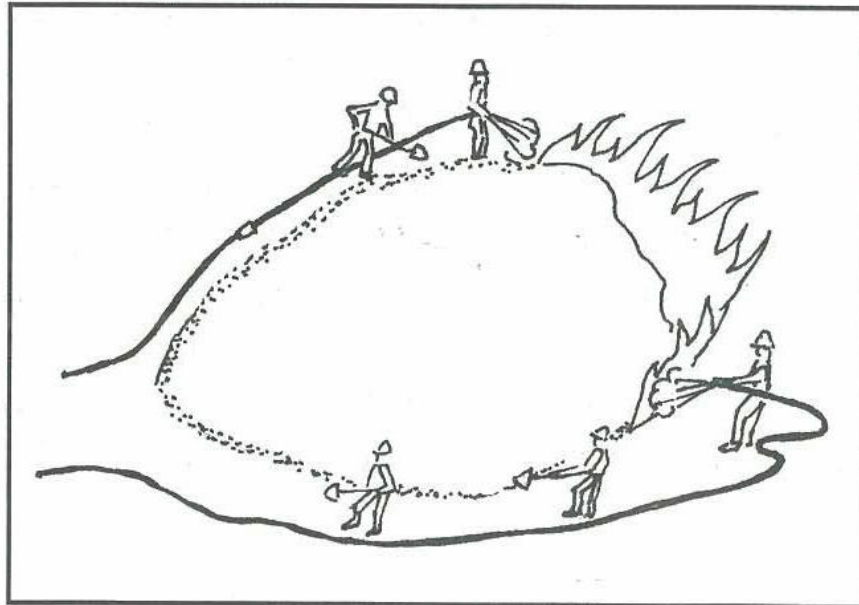

Flanking fires with this method of suppression, especially those spreading in one direction, is a common practice for several good reasons. The rate of the fire spread and fireline intensity on the flanks is often less than at the head of the fire, allowing personnel to work closer to the fire's edge and to make better progress than would be otherwise possible. Narrower firelines are required to contain the spread of the fire. Firelines can be safely anchored to natural barriers and it is generally easier to plan for and provide escape routes. And it may be the only safe area in which to work a direct attack.

Exposure Protection

The tactic of exposure protection involves using water to cool fuels or property ahead of, or adjacent to, the fire. The objective is the protection of values and exposures which are threatened by the fire.

Figure 20 – Exposure Protection

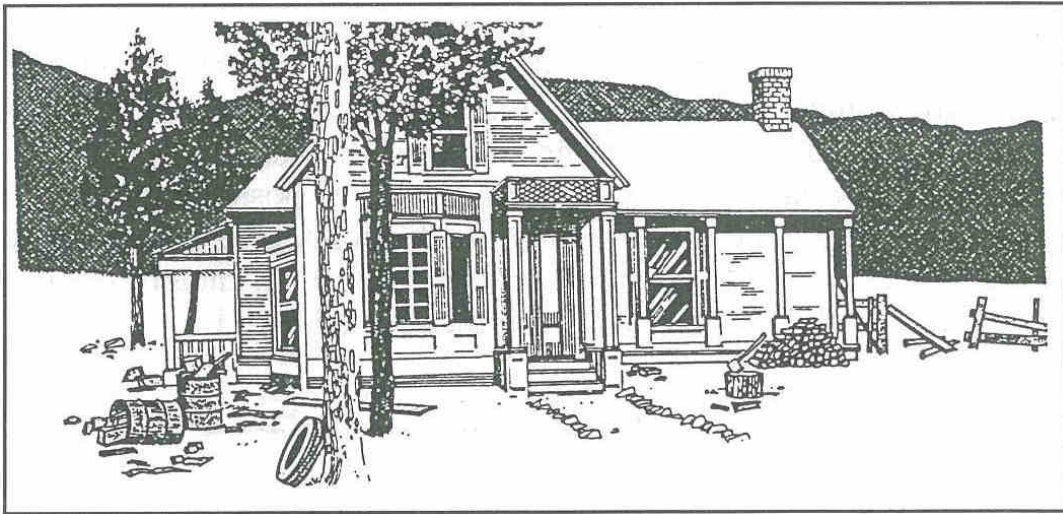

This method is used where priority is given to keeping fire out of high hazard fuel areas, away from high value property and away from public danger areas. The application here may be indirect or direct depending on whether fuels are being protected in advance of the fire or wetted as the fire directly threatens them.

With this method, water is used to protect fuels and exposures by forming a C) protective barrier against ignition, or by cooling and wetting the fuels in advance of the fire's spread. By raising the fuel moisture content of fuels they become less susceptible to ignition. The activities to achieve this tend to vary widely depending on the amount of water available and type of fuel protected. Where a large volume of water is available, the tactic may involve a hose lay incorporating sprinkler heads to protect a line during holding operations for burning out or backfiring or the fuels may be coated with foam to provide a barrier against radiant heat. In other situations, where water is less available, the application of water may not occur until the threat is more immediate and direct, as during holding operations for burnout and backfiring.

SURFACTANTS (WETTING AGENTS)

Surfactants are also called wetting agents. Surfactants reduce the surface tension of water which improves its wetting, penetrating, and spreading ability. Water treated with a surfactant will allow it to spread out over the fuel rather than run off.

Surfactants also change the physical properties of water. This change allows the water to bond to the carbon (charred fuels, ash etc.) which increases the penetration and ability to absorb heat.

Surface tension reduction will make the fog nozzle droplets up to three times smaller. As the water droplet size is decreased, there is more surface area to absorb heat. This is not readily visible, but its effectiveness is there.

Surfactants are effective in reducing time to extinguish fires in high hazard fuel areas, high value property areas, and public danger areas. Surfactants may reduce the potential for fire escape or rekindle in these areas.

CLASS A FOAM

Foams used in wildland firefighting today are mechanical foams, so-called because they are produced by agitating a foam concentrate mixed with water and air and are available from several commercial vendors. Class A foams have been divided into four types to describe the varied consistencies that can be generated for low expansion foams (see Figure 21). Foam type is important to understand how the foam will perform. A foam with a fast drain time and a 5: 1 expansion ratio performs differently than a foam with a slow drain time and a 15:l ratio.

Figure 21 – Types of Class A Foam

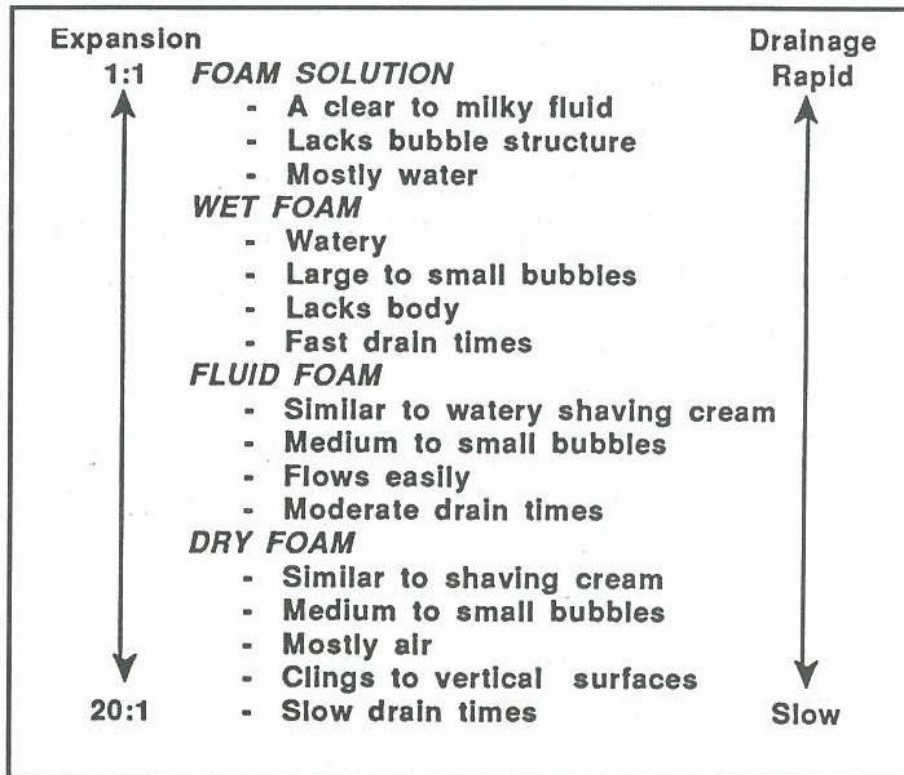

Expansion is the increase in volume of a solution resulting from the introduction of air. It is a characteristic of the specific foam concentrate being used, the mix ratio of the solution, the age of the concentrate, and the method of producing the foam. Different generators such as Compressed Air Foam Systems (CAFS) or aspirating nozzles produce foams having different expansion factors using the same foam solution.

A 10 to 1 (10:l) expansion of a one percent solution creates a foam that is 90 percent air, 9.9 percent water, and only 0.1 percent foam concentrate. The net result is a foam that is much lighter than water given the same volume.

Expansion ratios are divided into three classes related to how much foam is generated:

Low expansion foam	expands up to 20 times (1 : 1 to 20: 1)
Medium expansion foam	expands 21 - 200 times (21:l to 200:l)
High expansion foam	expands 201 -1000 times (201: 1 to 1,000: 1)

The stability of the bubble mass is measured by the rate at which the foam releases the solution from within its bubble structure. This process, known as drainage, is a measure of the foam's effective life. The use of cold water tends to decrease the rate of drainage, while the use of hard or saline water produces a much faster draining foam.

Drain time indicates how quickly the foam releases the foam solution from the bubble mass. Once the solution is released it becomes available for wetting of fuels or it may run off the fuel. Foams with short drain times provide solution for rapid wetting. Foams with long drain times hold solution in an insulating layer for relatively long periods of time prior to releasing it.

Consequently, a wet foam is a low expansion foam type with few and varied bubbles and rapid drain time which is used for rapid penetration and fire extinguishment.

A fluid foam is a low expansion foam type with some bubble structure and moderate drain time exhibiting properties of both wet and dry foam types which is used for extinguishment, protection, and mopup.

A dry foam is a low expansion foam type with stable bubble structure and slow drain time which is used primarily for resource and property protection.

Personal Safety And Protection

Foam concentrates are similar to common household detergents and shampoos. Fire suppressant foam concentrate, diluted for use in fire fighting is more than 99 percent water. The remaining one percent contains surfactants (wetting agents), foaming agents, corrosion inhibitors, and dispersants.

Approved fire suppressant foam concentrates have all been tested and meet specific minimum requirements with regard to mammalian toxicity.

Foam concentrates are strong detergents. They can be extremely drying and exposure to the skin may cause mild to severe chapping. This can be alleviated with the application of a hand creme or lotion to the exposed skin areas.

All of the currently approved foam concentrates are mildly to severely irritating to the eyes. Anyone involved with or working in the vicinity of foam concentrates should use protective splash goggles. Rubbing the eyes or face may result in injury to the eyes if hands have become contaminated with the concentrate during handling.

All containers of foam concentrate or solutions, including backpack pumps and engine tanks, should be labeled to alert personnel that they do not contain plain water, and that the contents **must not** be used for drinking purposes. If a foam concentrate is ingested, the individual should seek medical attention as soon as possible.

All personnel must follow the manufacture's recommendations as found on the product label and product material safety data sheet. To eliminate possible health problems from prolonged exposure to the skin and eye the following precautions should be taken:

1. When handling concentrates, goggles, waterproof gloves (rubber or plastic), and disposable coveralls should be worn. Leather boots should not be worn at the mixing site, since foam concentrate rapidly penetrates leather, resulting in wet, soapy feet.
2. Clothing soaked with foam concentrate should be removed and thoroughly rinsed with water.
3. Eyes splashed with foam concentrate or a foam solution should be flushed as soon as possible with large amounts of clean water for at least 15 minutes.
4. If skin contact occurs, wash off with water and remove contaminated clothing.
5. A non-allergenic lotion/hand cream should be used to avoid raw chapping of skin.
6. Inhalation of foam vapors can be irritating to the upper respiratory tract and should be avoided.

Slipperiness is a major hazard at storage areas and unloading and mixing sites. Because foam concentrates and solutions contribute to slippery conditions, all spills **must** be cleaned up immediately.

Spills of foam concentrate can be covered with sand or absorbent material and then removed with a shovel. Do not apply water directly to a spill area. Foaming and possible contamination to the surrounding area may result.

Spills **must not** be flushed into drainage ditches or storm drains. Do **not** flush equipment near domestic or natural water supplies, creeks, rivers, or other bodies of water. If a large spill occurs or concentrate enters a water supply contact your local authorities immediately. Be prepared to provide them with the appropriate manufacturer's information.

Care should be taken during planning that personnel applying foam from the ground are able to stand in untreated areas **as** they proceed. Stepping onto a foam blanket which conceals objects or holes can be dangerous.

Foam Application Techniques

In general, enough foam is required to provide adequate water to the fuels. An important feature of foam is that the applicator can see when enough has been applied because it is visible and stays where it is applied.

No matter what hardware is used to produce foam, it must be flushed with water after use to prevent corrosion and clogging of fluid passageways.

Direct Attack

Apply foam to the base of the flame. On wide hotspots secure the edge and work toward the center. While attacking the edge, direct some of the foam stream onto immediately adjacent unburned fuels.

For pump and roll (running) attack from engines, apply as you would a water stream, long enough to ensure extinguishment. This will not take as long as with water. Leave a foam blanket over the hot fuels to smother and continue to wet the fuel.

Foam's ability to wet and cool fuels long after the applicator has left the area is a key to effective foam use. Greater efficiency results as the applicator moves on to a new area because the foam will continue to work where applied.

Indirect Attack

Apply foam as a wet line adjacent to a backfire or burn out, immediately ahead of the ignitors. The foam line should be at least two and a half times as wide as the

flame lengths. Coat all sides of the fuel whenever possible. Apply foam at close range, as water would be applied, for penetration into ground and surface fuels. Then apply foam softly to the aerial fuels by lofting onto brush, tree trunks, and canopies to add an insulating barrier.

Medium and high expansion aspirating nozzles are effective for foam line construction during burn out and backfiring. Medium expansion foam can be applied in light fuels by pump and roll in single or double lines. Burnout between two parallel foam lines to create a fuel break. High expansion foam flows downhill nicely, creating foam lines from which to ignite without laying an extended hose lay.

Mopup

If foam was used in the attack, this may enable mopup to start earlier. Use of foam in mopup soon after the flaming phase is over helps prevent fires from becoming deep seated in the ground, requiring time-consuming mopup. This also eliminates residual smoke, reduces reburn potential and soil erosion. Begin applying foam on the edge of the burn and work in, concentrating on hot spots. Direct attack any flames. Apply foam as you would a water stream into burning material for best penetration. Before leaving the area, check for steam rising from the foam. Steam plumes indicate pockets of heat which need more attention.

A wet foam or fluid foam put on charred material early in mopup does the work of a conventional fog tip nozzle and a person with a hand tool. It quickly penetrates the fuel and the ground where it lays, and serves as a blanket to separate oxygen from any remaining smoldering fuel. This works extremely well on pitchy and punky material, duff and litter. For deep-seated fires in stumps, landings, and log decks a foam solution (see Figure 21-Types of Class A Foam) is the best type of foam to use. Application technique is no different than with water, but the foam is more efficient.

Medium expansion foam applied rapidly is an effective way to mop up a wide area of flame and smoldering surface heat. The foam blanket created smothers the fire, eliminates smoke, and does the work of many by slowly releasing foam solution onto hot fuels. Residual heat pockets requiring more attention will show themselves by releasing steam through the foam blanket.

Fire Proofing and Barrier Protection

The ability of foam to penetrate dead and live fuels quickly, to form an insulating blanket, and to cling to vertical and horizontal surfaces is very useful for fire

proofing and barrier protection; whether the fuel is stands of timber, areas of brush and grass, wildlife trees, snags, fuel jackpots, endangered plants, or log decks. Barrier protection is achieved with less water, less application time, and with fewer people than conventional methods.

The rate of foam application for barrier protection depends on air temperature, relative humidity, and fuel loading and moisture content. Foam is a relatively short-term treatment, longer than water, but shorter than retardant. It is most effective when applied immediately prior to ignition. Regardless of the conditions, compressed air foam remains longer than nozzle aspirated foam. Under moderate conditions where foam is expected to remain for more than a few hours, application time may be well before ignition time, but monitoring the foam blanket is a must.

The characteristics of foam important to barrier protection are its wetting ability and its durability. The foam must break down to wet the fuels and remain stable to maintain a protective barrier. Use the foam types (see Figure 21-Types of Class A Foam) as a guide for barrier protection.

Dry foam	Very slow wetting, strong blanket
Fluid foam	Good for wetting and blanketing
Wet foam	Weak blanket, rapid wetting

Apply the foam directly from a short distance at high pressure, as water might be applied, for penetration of foam mass to ground and surface fuels. For fireline application, most work can be accomplished right from the line. The width of the foam line depends on fuel and fire behavior factors. In Western Oregon Model 13 slash, 20 to 40-foot wide foam lines were used successfully. Apply foam to all sides of the fuel when possible. Apply foam to ladder fuels and crown fuels above the foam line. Apply as long as it is necessary to coat all fuels with the desired amount of foam.

Structure Protection

The ability of foam to adhere and stay in place over time to vertical, sloped, upside-down and slippery surfaces is the key to structure protection. Apply foam to outside walls, eaves, roofs, columns, or other threatened surfaces. Loft foam from a distance sufficient to avoid breakdown of the foam's insulative blanket. Durability of the foam blanket is consistent with weather and fire behavior. In general, CAFS foam lasts for one hour in hot weather, nozzle aspirated foam for 30 minutes.

Additional Material On Foam

The following material on foam is available from the Publication Management System (PMS) at the National Interagency Fire Center Warehouse.

Publications

Foam vs. Fire. Primer. 1992. (NFES 2270)

This nine page publication covers the basics of using class A foams and discusses their adaptability to present application equipment. First in a series of three "Foam vs. Fire" publications.

Foam vs. Fire. Class A Foam for Wildland Fires. 1993. (NFES 2246)

This 30 page publication explains how to get the most firefighting punch from water by converting water to class A foam. Discusses how and why foam works. Explains drain time, expansion ratio, foam type, proportioning, aspirating nozzles, and compressed air foam systems. Also discusses application for direct attack, indirect attack, mopup, structure protection, and safety considerations. Second in a series of three "Foam vs. Fire" publications.

Videotapes

Introduction to Class A Foam. 1989. (NFES 2073)

First of a videotape series dealing with foam use. This video is a brief introduction to class A foam technology covering foam chemistry, foam generating equipment, and examples of foam application (13 minutes).

The Properties of Foam. 1993. (NFES 2219)

Second in a videotape series about class A foam. This video explains how class A foam enhances the abilities of water to extinguish fire and to prevent fuel ignition. Basic foam concepts including drain time, expansion and foam types are explained (15 minutes).

Class A Foam Proportioners. 1992. (NFES 2245)

Third in a videotape series about class A foam. Explains how common foam proportioning devices which add a measured amount of foam concentrate to a known volume of water, work. Advantages and disadvantages are presented (24 minutes).

Aspirating Nozzles, 1992. NFES 2272

Fourth in a videotape series about class A foam. Explains how aspirating nozzles make foam, the difference between low and medium expansion nozzles, and appropriate uses for each nozzle (11 minutes).

Compressed Air Foam Systems, 1993, (NFES 21611

Fifth in a videotape series about class A foam. Describes equipment, including water pumps, air compressors, drive mechanisms, and nozzles used to generate compressed air foam. Presents general guidelines for simple and reliable foam production. Explains procedures for safe operation. Compares compressed air foam to air aspirated foam. Presents advantages and disadvantages of the system (20 minutes).

National Wildfire Coordinating Group Publication

Foam Applications For Wildland & Urban Fire Management, Sponsored by USDA, USDI, and National Association of State Foresters in cooperation with Canadian Forest Service. For a free copy contact:

Program Leader, Fire Management
USDA Forest Service
Technology and Development Center
444 East Bonita Avenue
San Dimas, CA 91773-3198
(909) 599-1267; FAX (909) 592-2309
DG, SDTDC:W07A

RETARDANTS

Retardants reduce the flammability of treated fuels.

Long-term retardants are commonly used in fire suppression and prescribed burning. They are more effective on heavy fuels than water, and remain effective longer (until washed off). However, the cost of long term retardant is much higher.

Short-term retardants are more effective on light fuels and are less expensive; but they lose their effectiveness when they dry out.

Retardants can be purchased in clear or colored types. Clear may be preferred in visually sensitive areas. Colored retardants are more effective to work with because treated areas are easily identified, making line location and construction more effective.

Fire retardants generally are not used much during mopup. Water is less expensive and less messy for crews to work with.

Usually, helicopter bucket drops are employed when a water source is close and abundant. It would not be a good delivery system in the case of either a limited water supply or a long turnaround time.

Delivery of water and retardant by aircraft will be covered in detail in Section 5, Tactical Air Operations.

FIREGELS

These are new additives, which like foam, expand water and adhere well to roofs, wood, and vegetation.

SECTION 3 - USE OF FIRE IN CONTROL OPERATIONS

This section is about the use of fire as an effective management tool to control wildland fires. Pay close attention to the emphasis on using anchor points, safety zones and escape routes during firing operations.

BURNING OUT AND BACKFIRING

There are two general methods of using fire to fight fire. These are burning out and backfiring.

Burning Out

Burning out is used with direct and parallel attack. In direct attack a fireline is built close to the edge of a fire. Burning out is setting fire inside the fireline to consume fuel between the fireline and the edge of the fire.

Parallel attack is generally defined as a method of suppression in which fireline is constructed approximately parallel to, and just far enough from, the fire edge to enable workers and equipment to safely operate. Parallel attack can shorten the fireline by cutting across unburned fingers. The intervening strip of unburned fuel is normally burned out as the fireline proceeds, (see Figure 1) but may be allowed to burn out unassisted where this occurs without undue delay or threat to the line.

Figure 1 – Burning Out

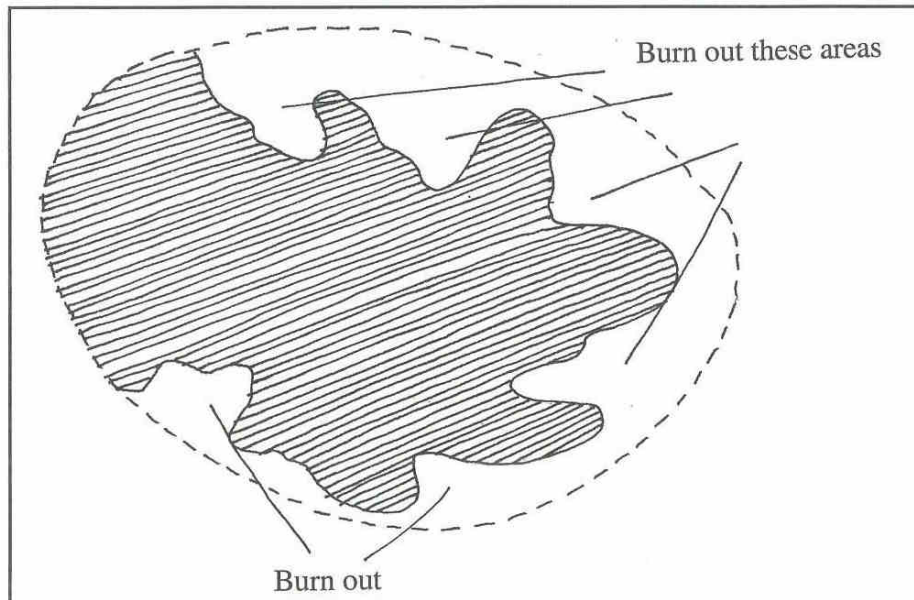

The primary objectives of burning out are:

- Removing of unburned fuels adjacent to the line.
- Reducing mopup time.

- Incorporating unburned fingers and spot fires into the control area during fireline construction.
- Hastening construction of safe, effective fireline. A "black line" is created and firefighters can keep one foot in the black (firefighters have an escape route back into the area where fuels have been consumed).

It is generally accepted that line personnel from crew boss on up have the authority to initiate a burnout operation as long as the direct or parallel attack mode is being used. Supervisory personnel must identify to subordinates the line of responsibility and authority prior to initiating the burn out. Supervisory personnel must coordinate all burning out operations with crew members and adjoining forces.

Backfiring

Backfiring is an indirect method of attack, (see Figure 2). It is the act of setting fire along the inner edge of a fireline to:

- Consume the fuel in the path of a wildland fire.
- Change the direction or force of the fire's convection column.
- Slow or change the fire's rate of spread.

Counterfires are sometimes used in conjunction with backfiring. Counterfires are set between the main fire and the backfire to hasten the spread of the backfire when large areas of unburned fuel are involved.

Page 106 Figure 2 – Backfiring

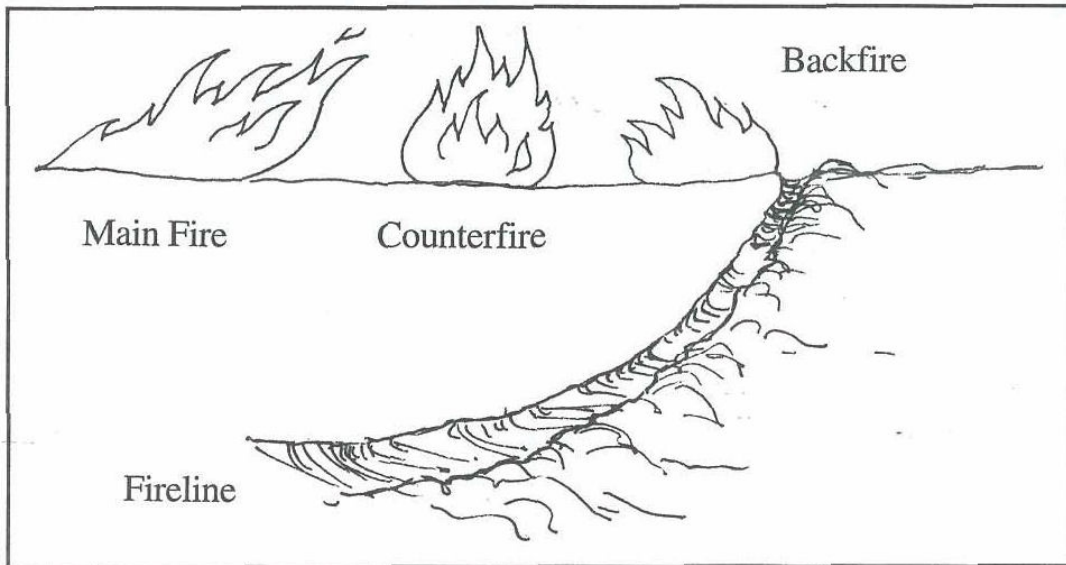

The primary objective of backfiring is:

- To eliminate fuel in advance of the fire, thus widening the fireline.
- To change the direction of the fire.
- To slow the fire's progress, allowing more time for suppression actions.
- To stop or reduce the fire's intensity and allow direct attack on the head of the fire.

The decision for backfiring is usually made by the operations section chief, based on the recommendations of other applicable personnel. It is then approved by the incident commander and put into effect at the division level.

Backfiring is an effective tactic against wildland fire, but because of the complexity, it generally requires more planning and coordination than burning out. The following items need to be evaluated before conducting a backfire operation:

- Current and expected fire behavior
- Timing
- Location of control lines
- Anchor points
- Safety zones or escape routes
- Control line preparation
- Equipment for firing and holding
- Firing methods and techniques
- Organization
- Coordination
- Communications

Remember, the distance from the fireline to the main fire is not the determining factor of whether to call it a burnout or backfire operation. The difference is the intent and the complexity of the burning operation. With burnout operations, the planning process is usually fairly rapid with immediate implementation. The complexity of backfire operations requires more thorough planning and implementation. It often is delayed until conditions warrant.

TYPES OF FIRE SPREAD

A key element one must consider prior to conducting a firing operation is the type of fire spread that needs to be created or sustained to safely accomplish the assignment. There are three types of fire spread: head fire, backing fire and flank fire. These terms describe the behavior and spread of wildland fire, as well as the type of fire spread necessary to complete a burnout and/or backfire.

Head Fire

A head fire is generally a fire front spreading with the wind. However, a fire front spreading uphill against the wind could also be termed a head fire if the angle of the flames, with respect to the unburned fuels, is less than 90 degrees (see Figure 3). Head fire spread may develop rapid and intense runs, strong convection columns, and consume large amounts of fuel in a short period of time. **Do not confuse head fire with head firing** (see Figure 13).

Figure 3 – Head Fire.

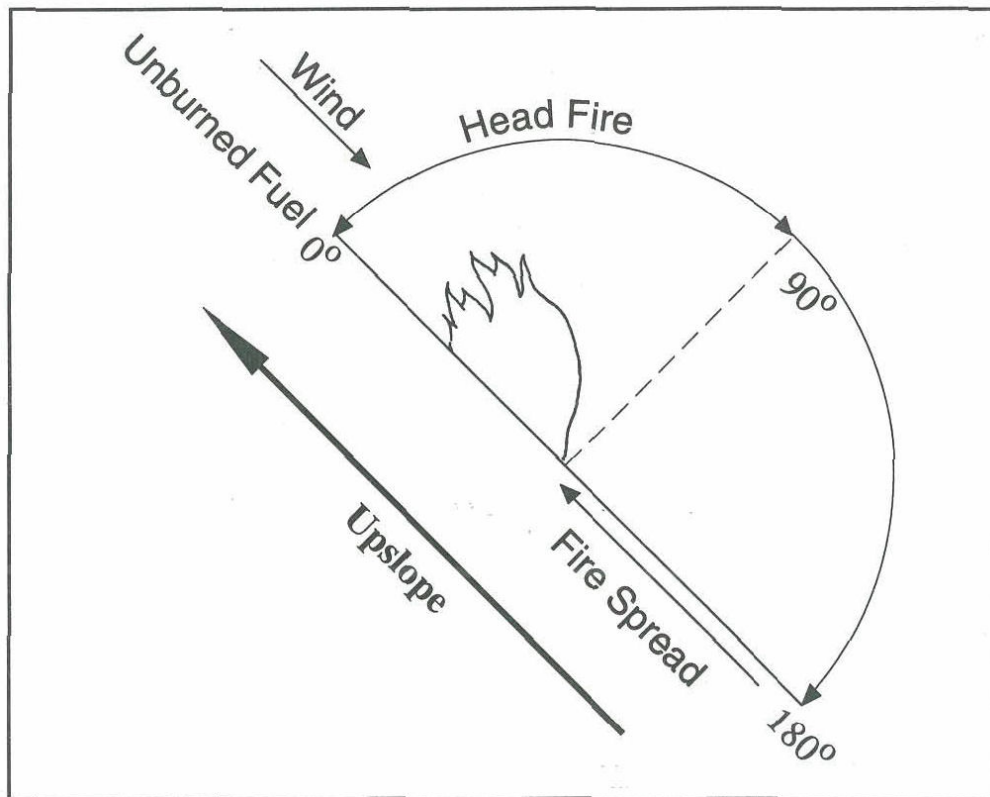

Backing Fire

A backing fire is generally a fire front spreading against the wind. However, a fire front spreading downhill with the wind would also be termed a backing fire if the angle of the flames, with respect to the unburned fuels, is more than 90 degrees (see Figure 4).

Figure 4 – Backing Fire

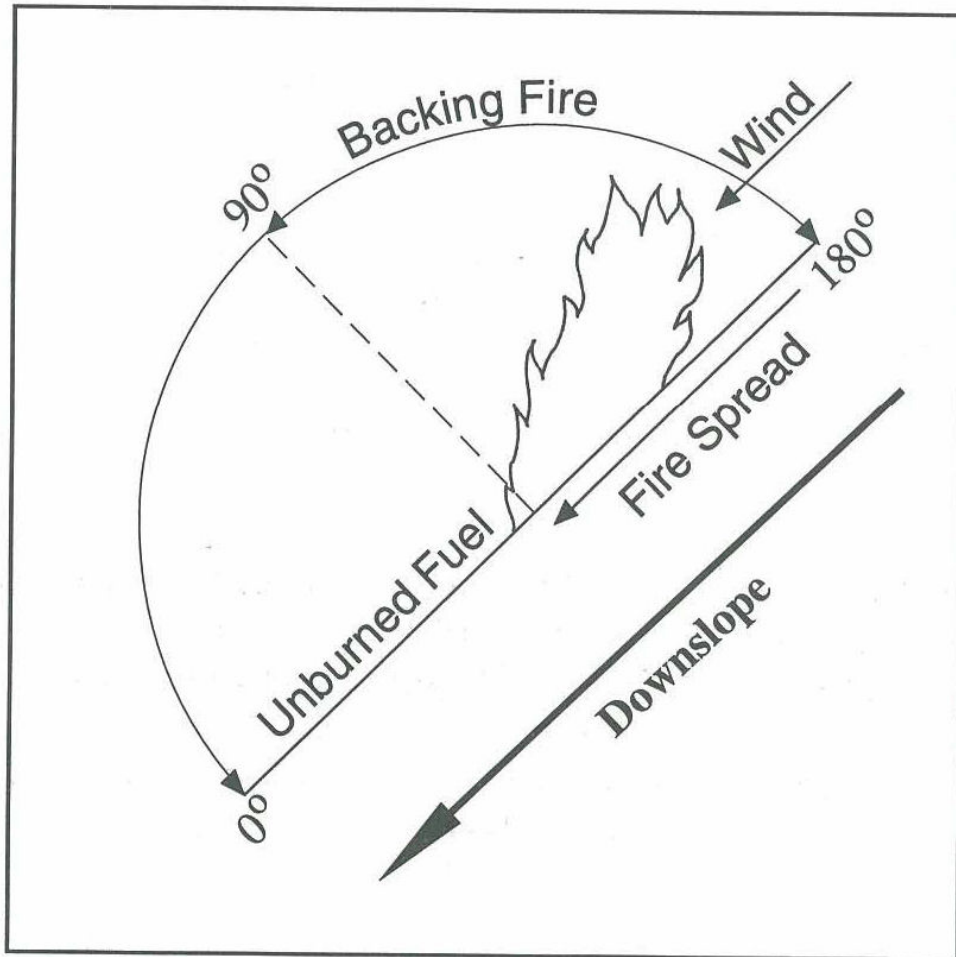

A fire spreading on level or downward sloping ground with no wind is also a backing fire. This type of fire spread involves backing fire downhill (see Figure 5) or into the wind (see Figure 6). Fire is started along a natural or constructed barrier such as a road or fireline and is allowed to back into the wind or down a slope. Using this type of fire spread results in a low intensity fire and minimum scorch height, and provides maximum safety for fire personnel. A disadvantage is that it is time consuming. **Do not confuse this type of fire spread with back firing.**

Figure 5 – Backing Fire (Slope Condition).

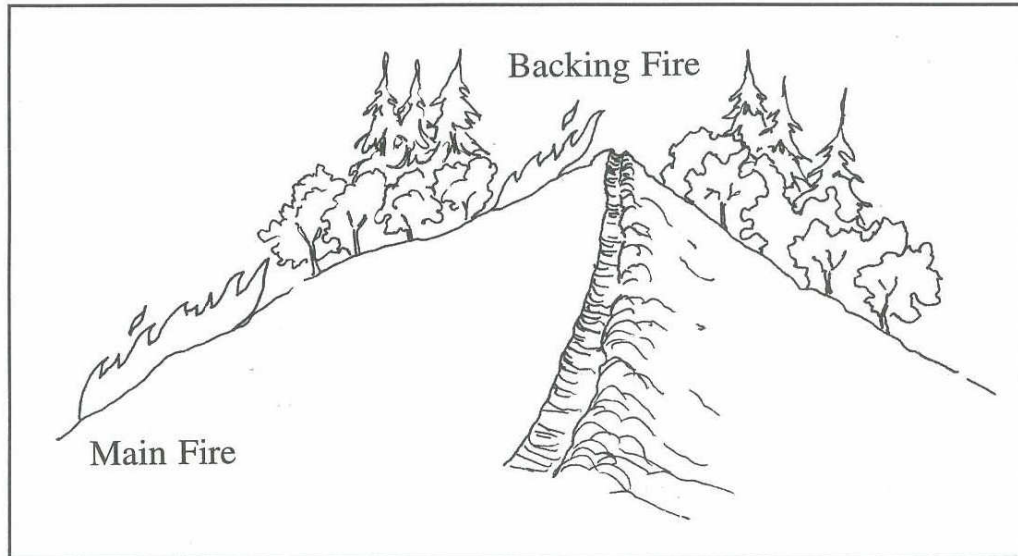
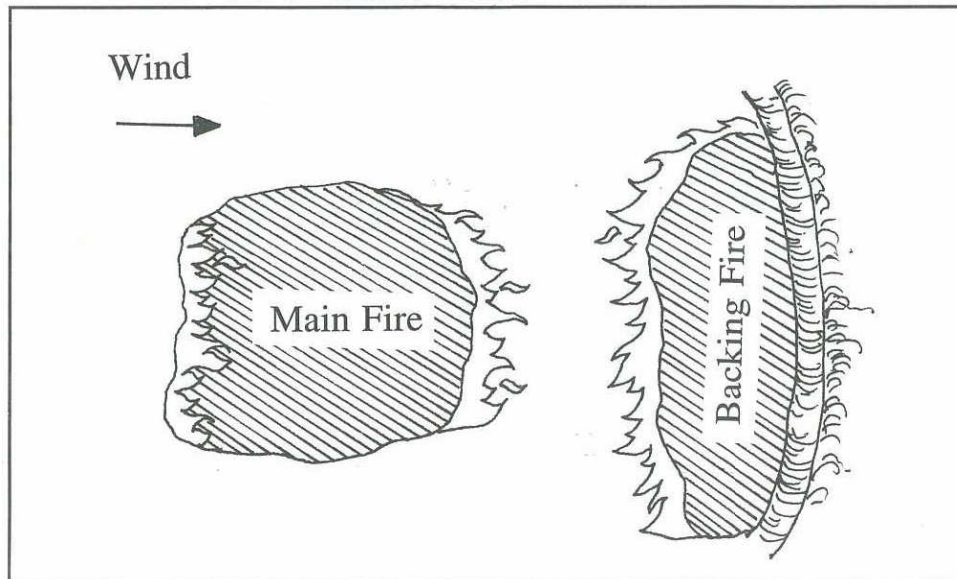

Figure 6 – Backing Fire (Wind Condition)



Flank Fire

A flank fire is a fire spreading perpendicular to the direction of the wind. However, a flanking fire is generally associated with a firing operation (burnout and/or backfire). Fire is set along a control line parallel to the wind and allowed to spread at right angles, toward the main fire. A principle use of flanking fire is to secure the flanks of a head fire or backing fire as they progress. Utilizing this kind of fire spread allows for very little variation in wind direction and requires coordination and timing to get the ignited flanking fire to burn into the main fire (see Figure 7).

Figure 7 – Flank Fire

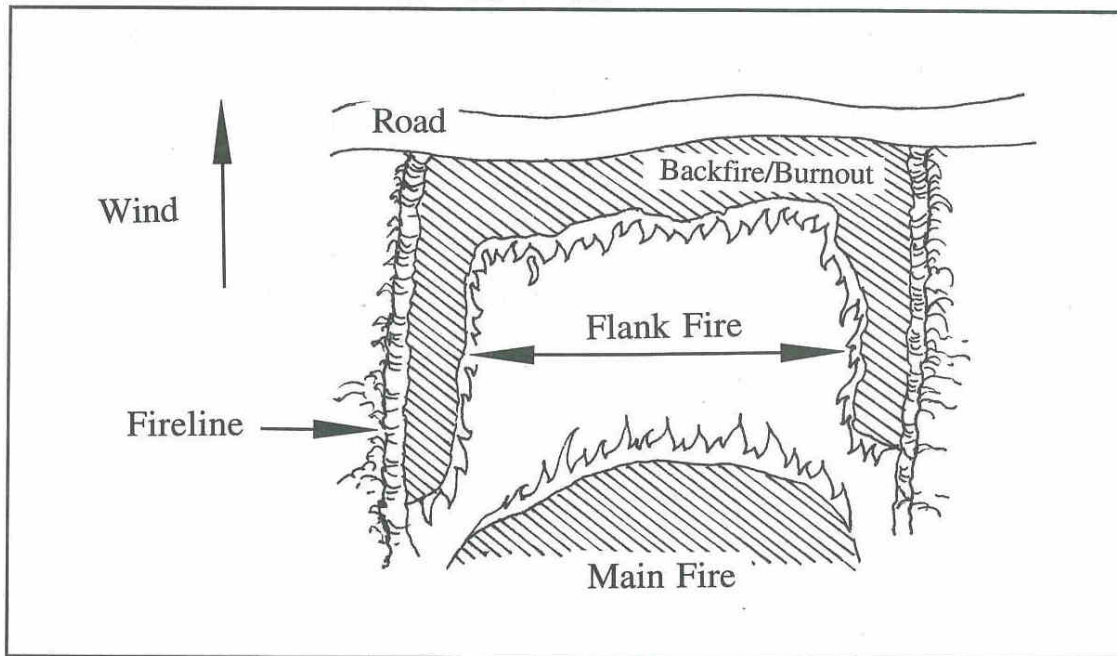

IGNITION TECHNIQUES

There are six ignition techniques and many variations commonly used in conjunction with the three fire spread types (head, backing, flank). The ignition techniques include strip firing, blowhole firing, spot firing, ring/perimeter firing, chevron firing, and burn strip. These ignition techniques are used in both burning out and backfiring. Remember, it is the method of attack (direct, parallel, indirect) and complexity that determines whether a firing operation is a burnout or backfire. The ignition technique and fire spread type used primarily control the rate of ignition, intensity, and spread direction of a firing operation. In most ignition techniques the fireline becomes the escape route for the firing personnel. **In all firing operations adequate anchor points, escape routes, and safety zones must be established and identified prior to beginning firing operations.**

Strip Firing

This is the most commonly used ignition technique. It involves setting fire to one or more strips of fuel and allowing the strips to burn together. Lighting numerous strips allows fast area ignition. By varying the width of the strips and their location in relation to the slope and/or wind direction a means of regulating the fire's intensity can be provided (see Figures 8-1 1).

Figure 8 – Strip Firing (Favorable Wind)

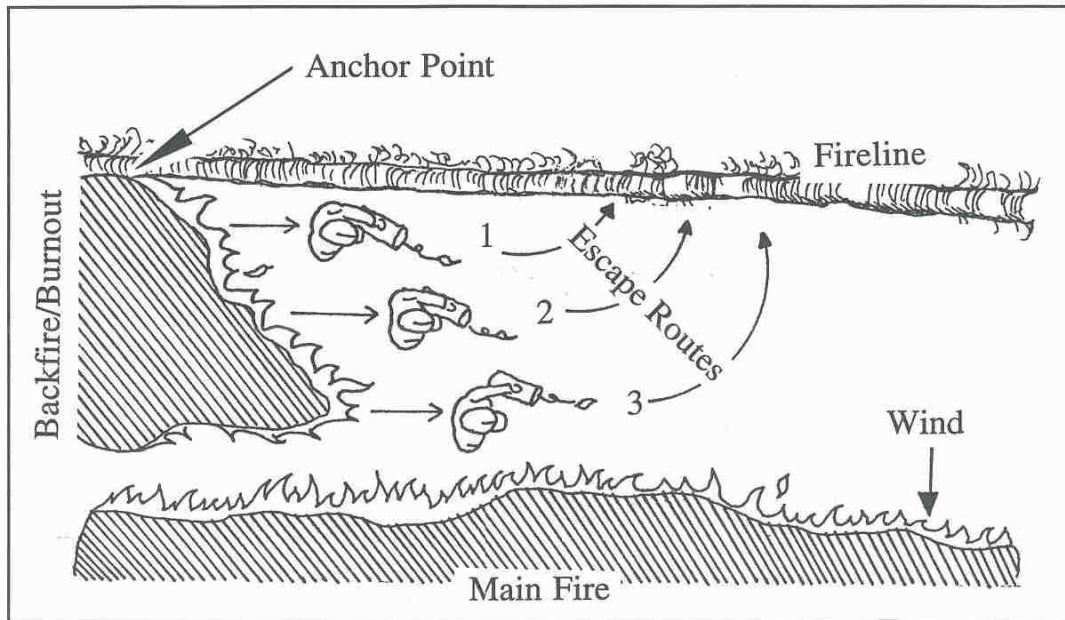

Figure 9 – Strip Firing (Favorable Slope)

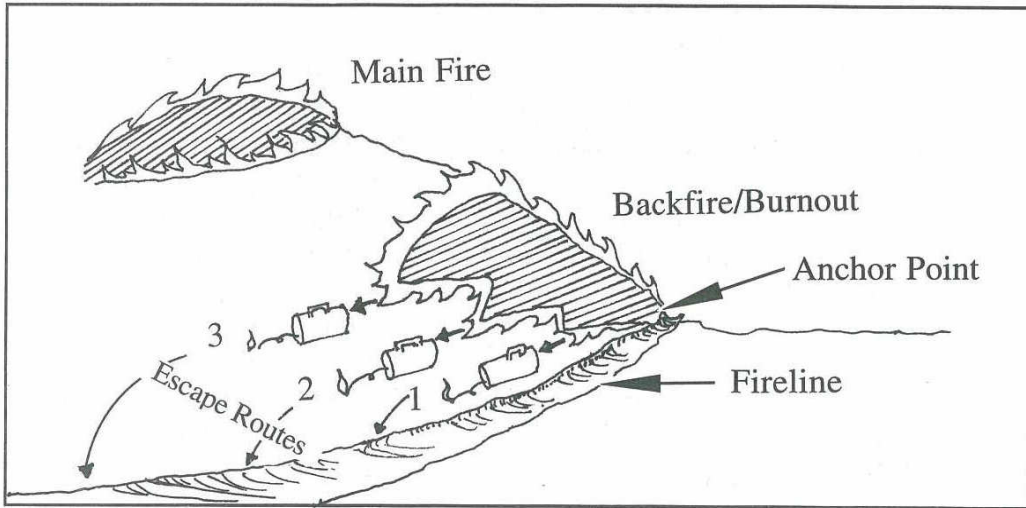

Figure 10 – Strip Firing (Adverse Wind)

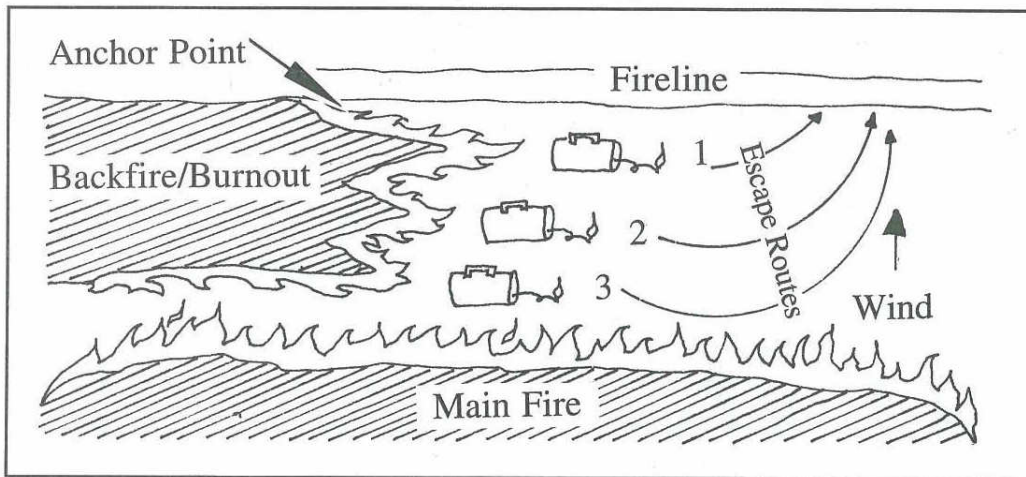
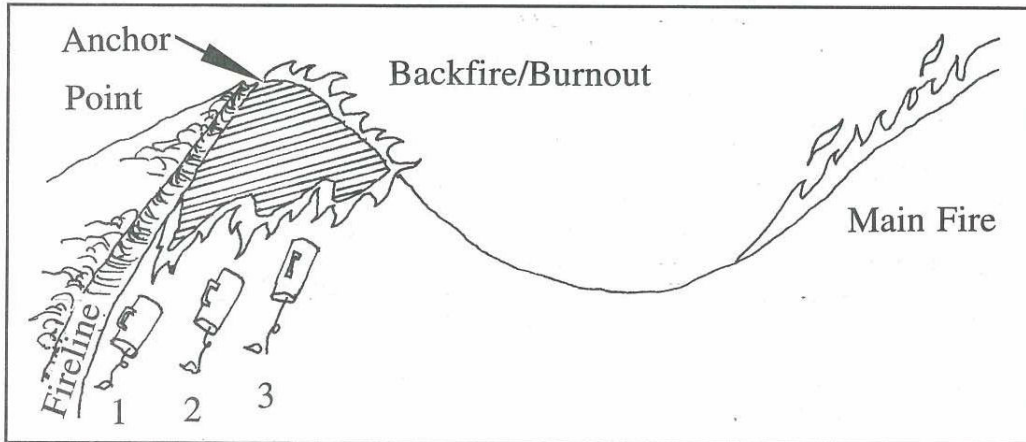

Figure 11 – Strip Firing (Adverse Slope)



A concept referred to as the "One, Two, Three - Three, Two, One" (1-2-3/3-2-1) is commonly used by crew firing organizations during strip firing operations (see Figure 12).

Figure 12 – "One, Two, Three - Three, Two, One" (1-2-3/3-2-1)

Example 1 - "1-2-3" Concept
Lighter #1 is **Always** Closest to the Control Line

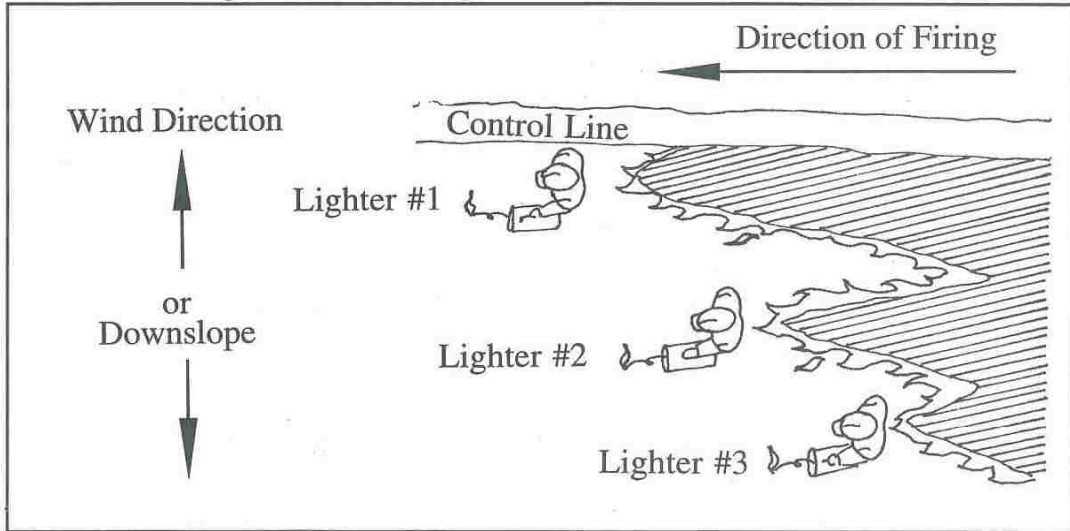

Example 2 - "3-2-1" Concept
Lighter #1 is **Always** Closest to the Control Line

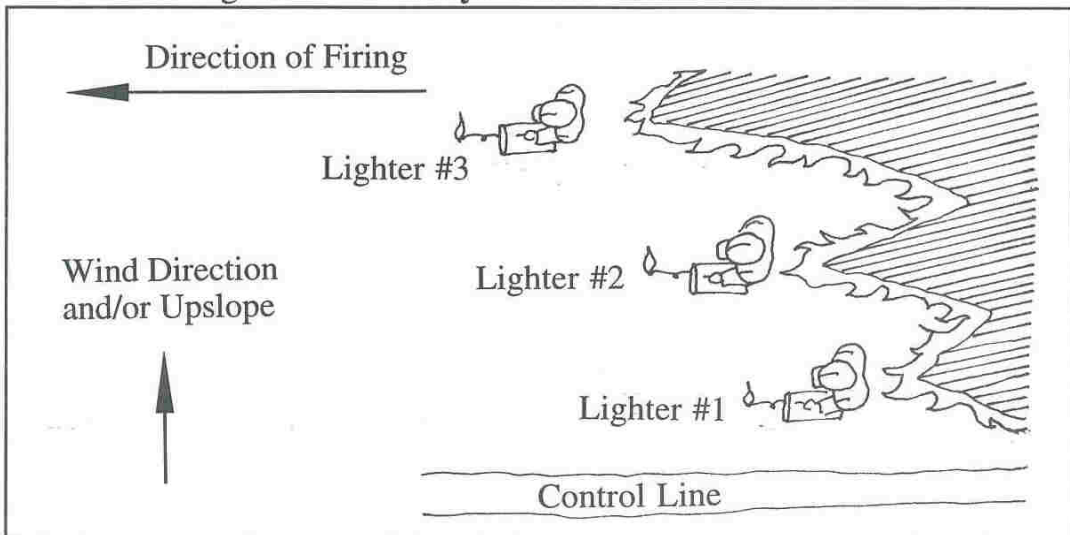

When a firing operation requires two or more lighting personnel, each lighter is assigned a number, i.e., lighter 1, lighter 2, lighter 3, etc. The lighter 1 position is always the closest to the control line. Depending on the wind and/or slope conditions, lighter 1 may not always be the lead lighter.

Example 1 of Figure 12 represents wind/slope conditions (normally considered adverse) that require lighter 1 to function as the lead lighter with lighters 2 and 3 following behind. This example is referred to as the "1-2-3" firing organization.

Example 2 of Figure 12 represents wind/slope conditions (normally considered favorable) that allow lighter 3 to function as the lead lighter with lighters 2 and 1 following behind. This is referred to as the "3-2-1" firing organization. The common element within the concept is lighter 1 is always the closest to the control line in both firing organizations.

In addition, firing team personnel can be given commands incorporating depth and width of strips when using two or more lighters during various firing operations. In a strip firing operation the entire command would be relayed to the firing team by the firing boss as in this example: "Your firing specifications are to 1-2-3 strip with 50-20 spacing." Translated: There are three lighters assigned, lighter 2's strip is 50 feet behind and 20 feet deeper into the unburned fuel from lighter 1. Lighter 3 is 50 feet behind and 20 feet deeper into the unburned fuel from lighter 2. If burning conditions allow, lighter 1 walks a position up to 20 feet inside the unburned fuel from the control line. If conditions do not allow for lighter 1 to take the entire first 20 feet, that lighter can vary the depth of the strip to regulate the required level of fire intensity in relation to control line specifications and the abilities of the holding resources. This concept adapts readily to most firing operations and is easily understood by crew personnel.

Head Firing or Strip Head Firing

Head firing or strip head firing involves setting fire and allowing the wind or slope to carry the head fire (see Figure 13). Head firing results in a high intensity fire, but consumption of fuels can be spotty because of rapid rate of spread.

Figure 13 – Head Firing

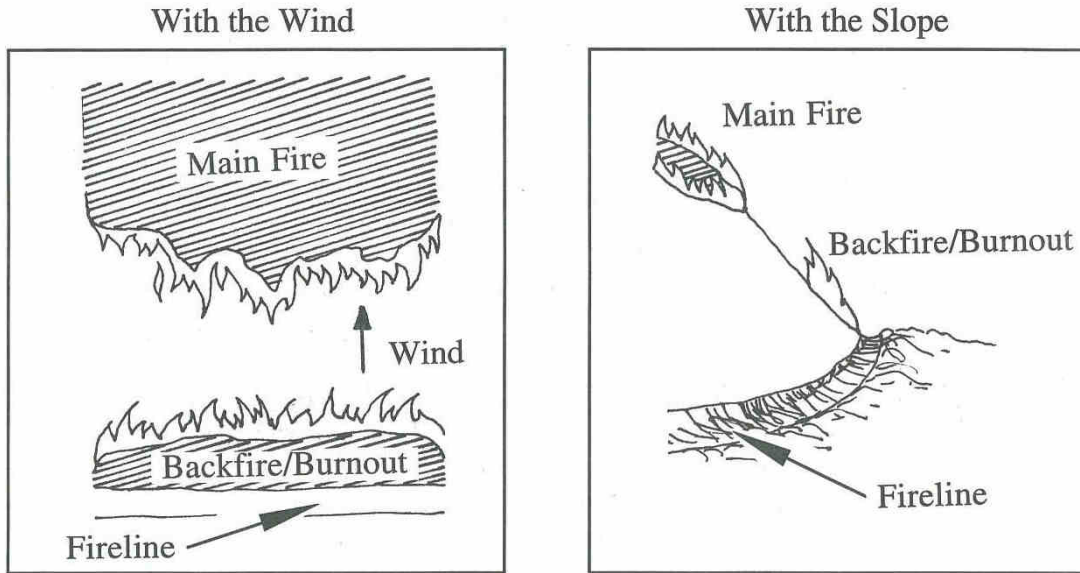

Blowhole Firing

The purpose of blowhole firing is to fire shorter sections at a time making the control line easier for crews to hold.

This ignition technique can be very dangerous for the lighting personnel. It should be used only by experienced firefighters with stringent and constant observation of lighters at all times.

Blowhole firing, when used in advance of a fire, is normally conducted as an indirect attack and backfire operation (see Figure 14). Firing commences from the control line on a 45 degree angle towards the main fire to a point dictated by the current fire behavior and other conditions and then the strips are turned back to the control line. The depth of firing is determined by personnel safety, wind, slope and desired effect. This technique, when hand fired, should be practiced only where the firing area can be traversed fairly easily on foot.

Figure 14 – Blowhole Firing Backfiring Against the Wind (1-2-3 Organization)

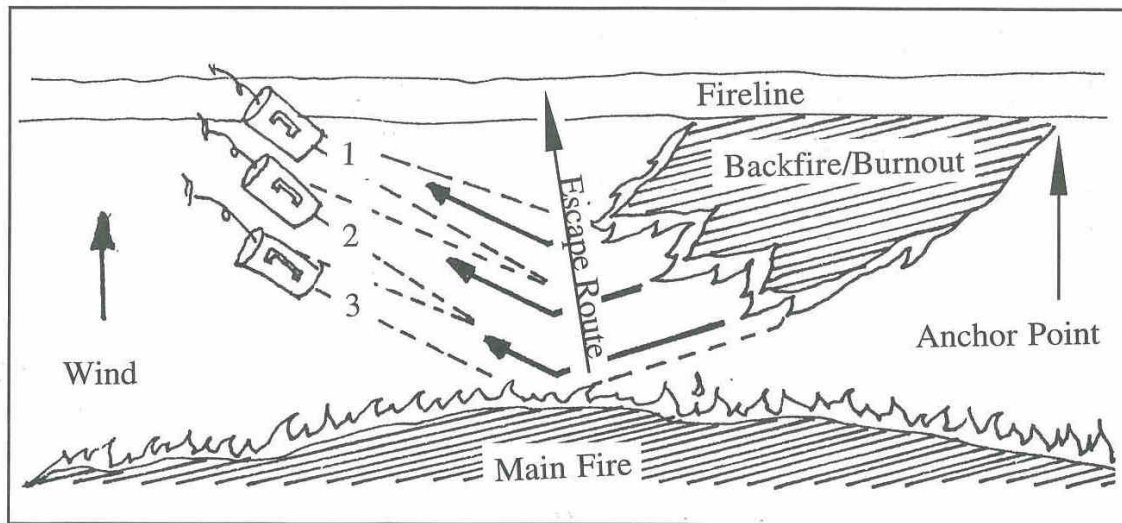

It is more commonly used on the flanks as a form of strip firing when crews are making direct or parallel attack. When used on the flanks, strips are fired on a 45 degree angle downhill or into the wind. One or more strips are lit (either by aerial device or hand fired) on a 45 degree angle from the control line towards the main fire to a point (determined by the current conditions) and then back to the control line (see Figure 15).

Figure 15 – Blowhole Firing (Backfiring/Burning Out on Flanks)

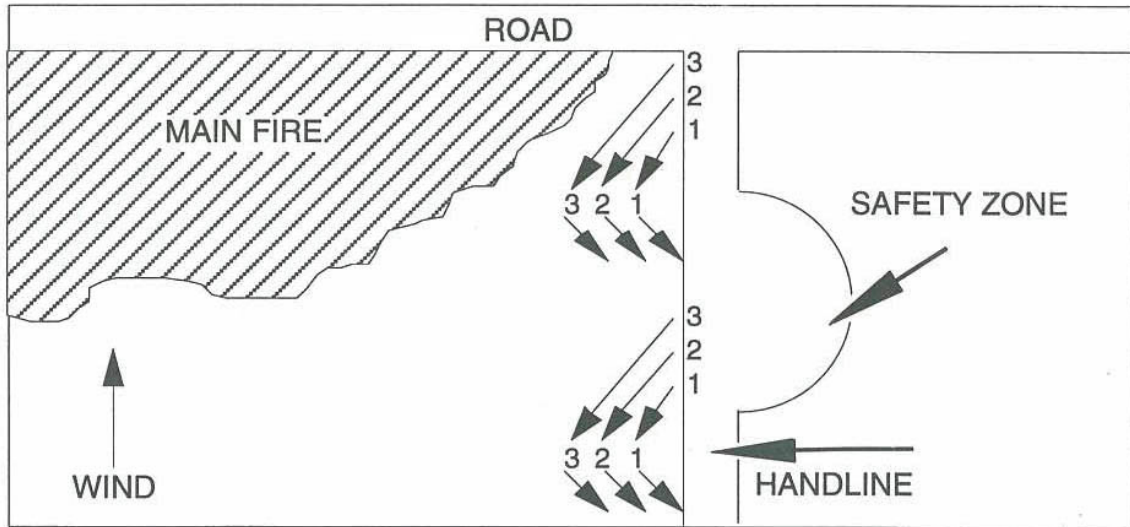

Spot Firing

This technique allows fast ignition and elimination of pockets of heavy fuel when fine fuel moistures are high.

This technique employs a series of small spot fires. These spot fires burn in all directions and come together, minimizing the possibility of any one spot gaining sufficient momentum to start a hot run. Timing and spacing of spot ignitions is the key to successful application of this technique (see Figure 16). Aerial mounted firing devices produce this type fire. Spot firing is commonly used in conjunction with strip firing. **Do not confuse this technique with spot fire.**

Figure 16 – Spot Firing

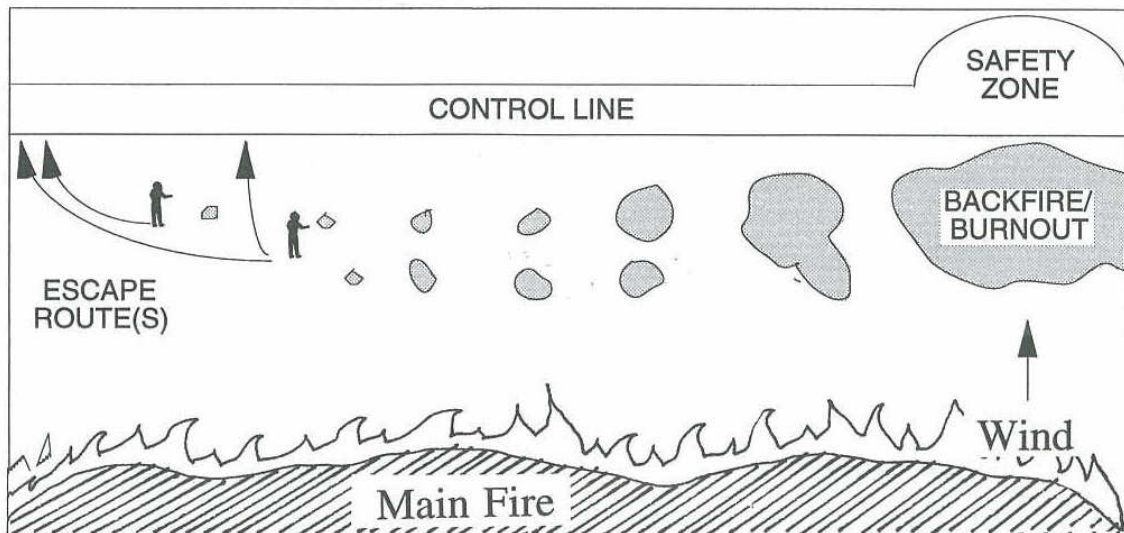

Ring Firing

This technique is generally used as an indirect attack and backfire operation. It involves circling the perimeter of an area with a control line and then firing the entire perimeter (see Figure 17). Ring firing is often used to bum out around structures, preserve historic or archeological sites, or protect endangered species. However, firing personnel may not have a strong anchor point to commence firing. Escape routes and safety zones must be established.

Figure 17 – Ring Firing

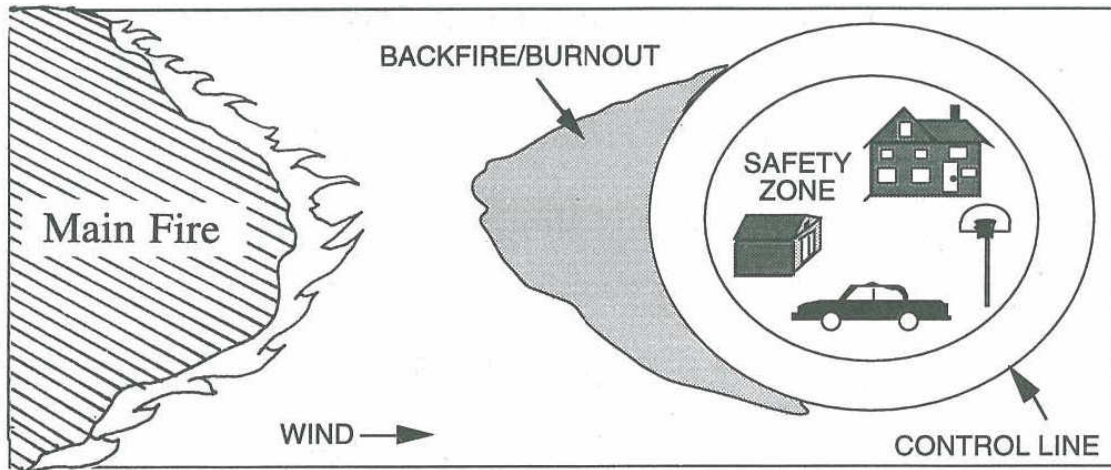

Chevron Firing

This technique is generally used during prescribed fire application. It establishes a line of fire in a V-shaped pattern to burn off ridge points or ends. The burn progression must be down hill. Chevron Firing should be used in combination with other firing techniques. When hand firing, this technique requires three or more lighters. The lead lighter is the center/point position and generally initiates the first strip from the top of the ridge working downhill. Lighters spaced at left and right positions are determined on personnel safety in relation to topography, fuels, and fire behavior conditions (see Figure 18). Using aerial ignition devices provides the greatest amount of personnel safety and expedites the overall operation.

Figure 18 – Chevron Firing

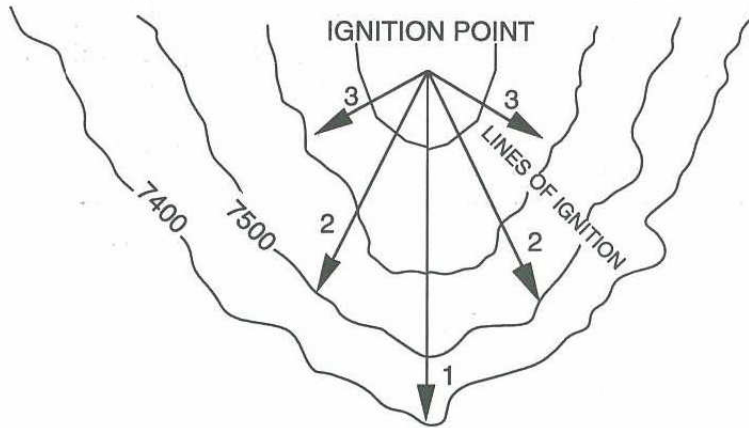

Top View

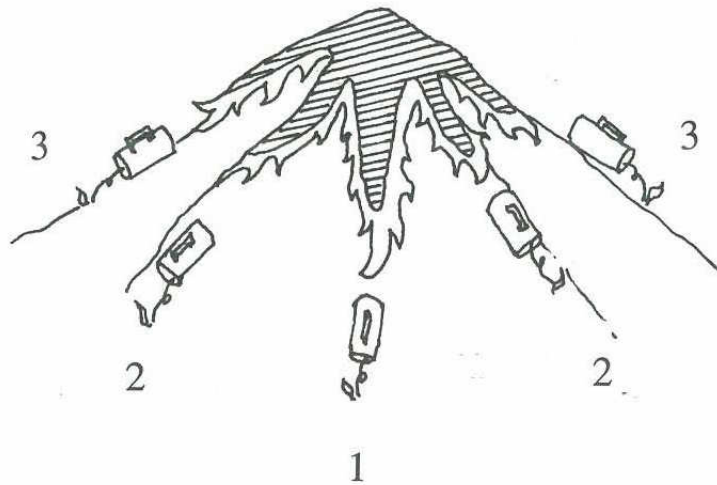

Side View

Burn Strip

Generally this technique is used more as a line construction method rather than an actual ignition technique. Two parallel control lines are constructed, i.e., dozer lines, dozer/highway combination, wet lines in light fuels, etc., and then the inner lying fuel is burned out. This concept is commonly used along existing roadways as a means of hazard reduction and presuppression effort (see Figures 19 & 20).

Figure 19 – Burn Strip (Backfiring in Front of Head Fire)
Burn at Anchor Points First

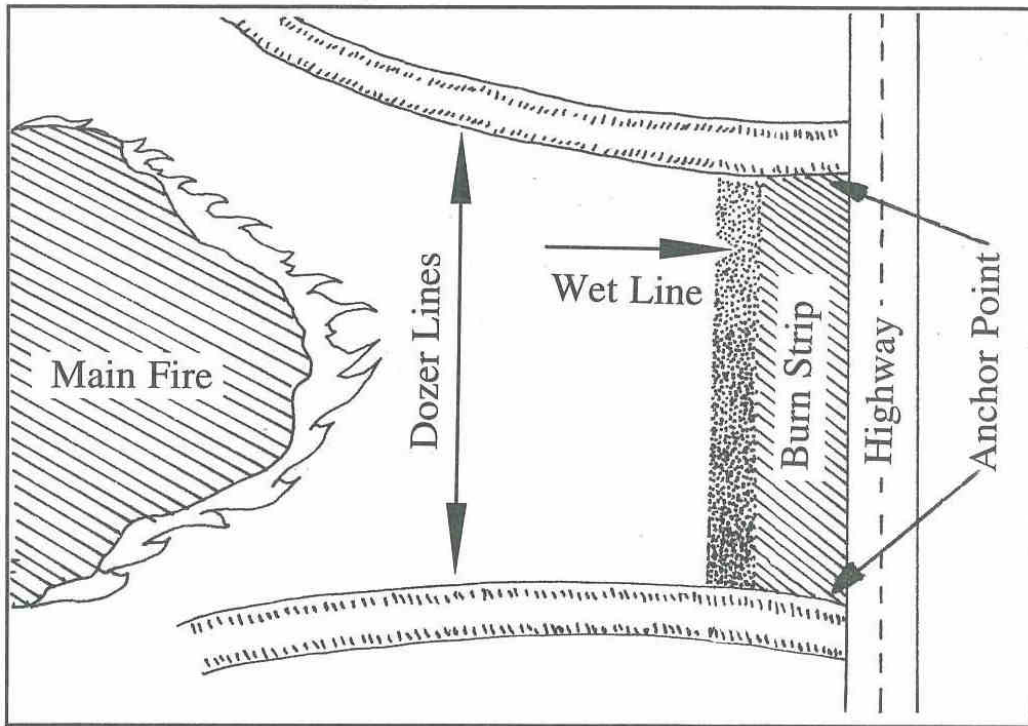
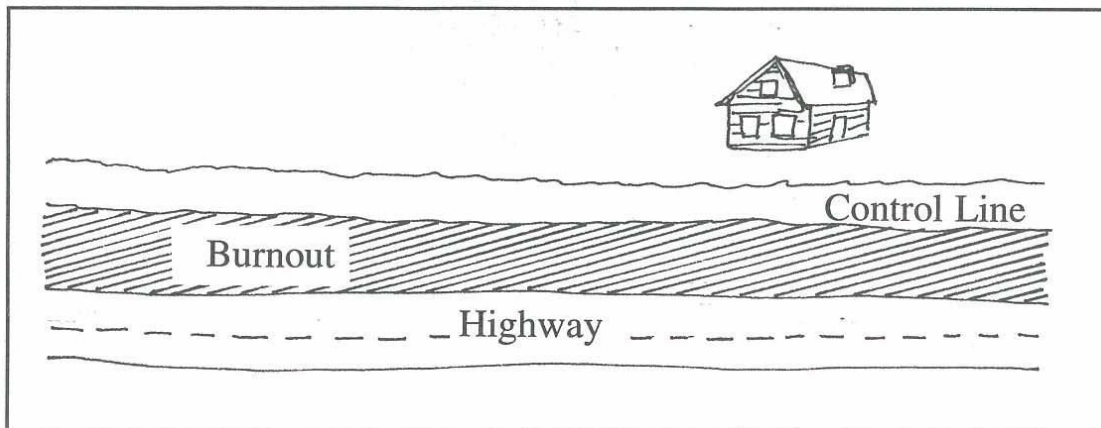

Figure 20 – Burn Strip
(Burning Out Between Two Parallel Control Lines as a Line
Construction Method or Hazard Reduction Along Roadways)



PLANNING AND CONDUCTING FIRING OPERATIONS

Before firing operations can begin, control lines must be located to safely meet control objectives. Firelines should be tied or anchored to safe points of control. Examples of anchor points are: high points, barriers (both natural and human made), recently burned areas, other fuel voids, or firelines in adjacent divisions.

Proper timing is essential in conducting a successful firing operation. There are several points to consider. Conditions must be good enough to permit a reasonably clean burn. Firing too early in the day or too late in the evening might result in unburned islands of fuels, potential for reburn, and mopup problems. If fire behavior conditions are too extreme, or there is not enough time, firing must be suspended until more favorable conditions exist. Finally, and perhaps most importantly, the main fire can approach and threaten the control line at different points and times; thus, firing must be done in a planned sequence, with those areas presenting the most serious threat to control being attended to first.

When organizing a firing operation, remember these basic principles:

- Don't jeopardize personnel or equipment.
- Keep firing crews as small as possible and only use trained personnel. It's important that only one individual be in charge of the entire operation.
- Know the chain-of-command and use it. Remember, personnel should be allocated for firing, holding and lookout duties.

Communications are a difficult but extremely important area to manage. Here are five essential considerations when dealing with communication:

- Advise your supervisor of preparations, schedules, logistics and supply needs before firing.
- Establish radio communications with key personnel.
- Brief all involved personnel on the firing plan.
- Check for the latest weather forecast.
- Report progress and results of the operation to your supervisor. Keep people informed as the operation progresses.

Remember, the single most important factor during any tactical firing operation is personnel safety. Provide the necessary communications to safely perform the assignment and keep firing personnel and adjoining forces advised of conditions.

SPECIAL FIRING CONSIDERATIONS

When necessary secure the corners and control line as anchor points prior to igniting the firing operation. Figure 21 is an example of securing corners as anchor points.

Figure 21 – Secure Corners As Anchor Points

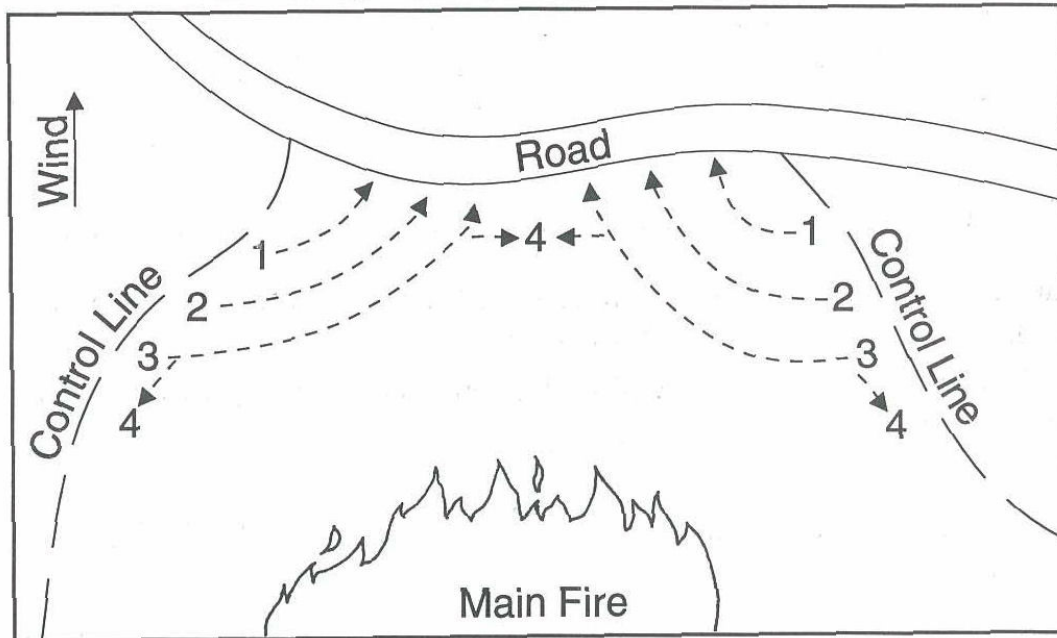

Begin firing from higher elevation and work downhill. This will prevent intense uphill runs. An exception is when strong, steady downhill winds are present.

To hold a line with a smaller defensive force, light the line to give a narrow flame front to the line.

When firing from a ridgeline, start from the back side of the ridge, not on top (see Figure 22).

Figure 22 – Firing From A Ridgeline

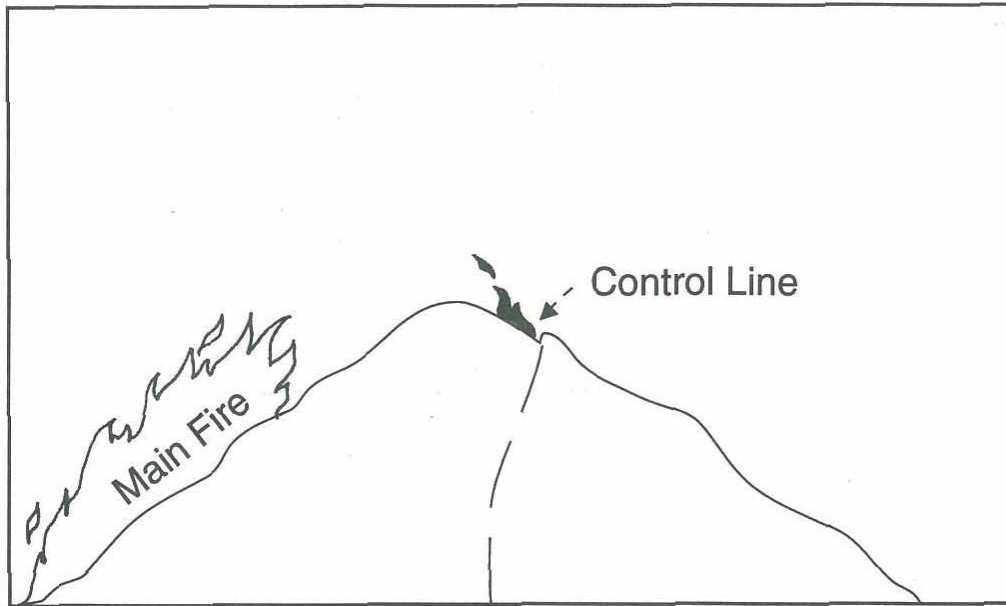

If the main fire is backing down one slope in a V-shaped canyon, begin firing a short distance from the bottom of the slope on which the fire is burning (see Figure 23). However, a head fire may be too intense and you might want to use strip firing.

Figure 23 – Firing In V-Shaped Canyons

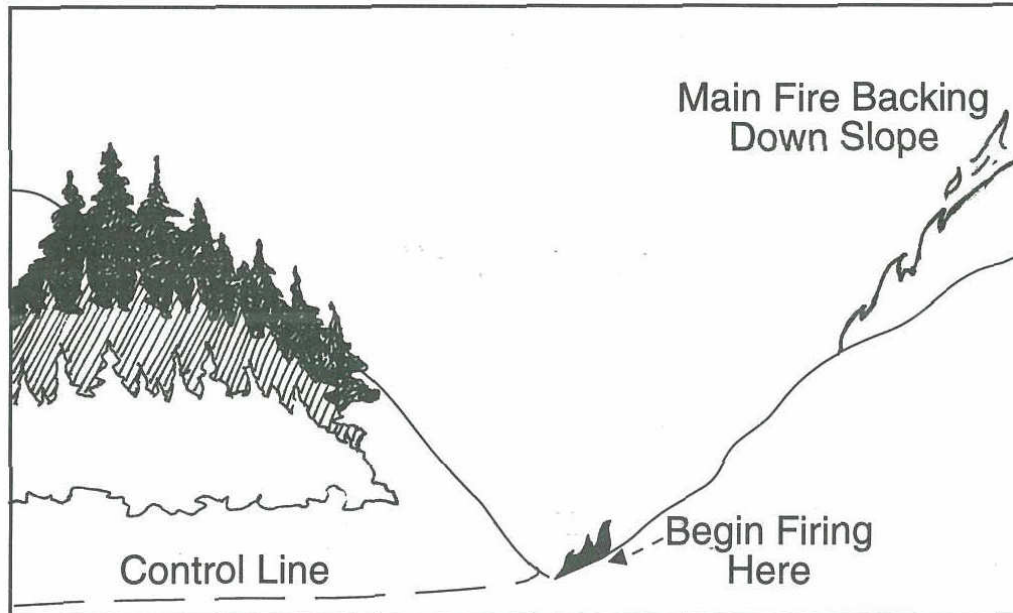

When firing a saddle burn into the saddle simultaneously from both directions. In Figure 24 firing would begin at points A and C at the same time. From points A and C firing would continue simultaneous reaching point B about the same time.

Figure 24 – Firing Saddles

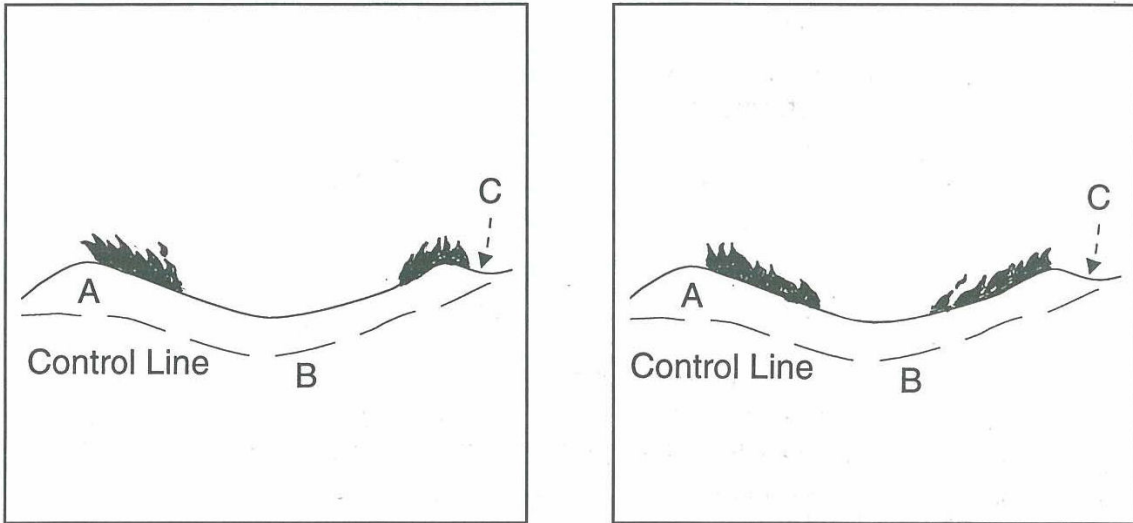

FIRING EQUIPMENT

Equipment that can be used in a firing operation includes primary devices and secondary devices. Primary devices are: fusees, drip torches, matches, and natural fire. Secondary devices are: pneumatic torches, propane torches, Very pistols, flare pen, fusee launchers, blivets, power flame throwers, Burnol Bursters, helitorches, ping-pong ball machine, and fusee gatling gun.

Fusee - This is the most widely used firing device. It projects very hot flame, can be broken into sections, ignited, extinguished, and re-ignited; burns approximately 20 minutes depending on size; and comes in boxes of 72 each. The fusee is most effective in *dry*, light, continuous fuels and is classified as a "Flammable Solid" by the Department of Transportation (DOT).

Drip Torch - A hand-held device, the drip torch incorporates fuel oil (or diesel) mixed with gasoline (normally 3 parts oil or diesel to 1 part gasoline), which is dripped from the canister past a flaming wick to be ignited. This device works well on almost all fuel types and is used for long firing jobs. One full tank used judiciously can last approximately 1 hour. Diesel fuel is classified as a "combustible liquid," and gasoline is classified as a "flammable liquid." Diesel/gasoline is classified as "flammable."

Matches - Kitchen (wooden) preferable, but paper matches also are effective when ignition is easily attainable. Best in light dry fuels, used in conjunction with other firing devices as a source of ignition.

Natural Fire - During direct-line construction, natural fire is normally readily available and can be moved with hand tools or hand carried. Examples are: hot coals, yucca stalks or pine boughs, cedar bark, slash, or palm fronds.

Pneumatic Torch - This device incorporates a backpack tank with diesel fuel under pressure expelled through a nozzle past a burning wick. Torches can project burning fuel from 8 to 20 feet, depending on model, and can be used to apply diesel fuel to heavy fuels when ignition is slow, difficult, or sparse. Torches can be used to supplement fusees and drip torches when they are inadequate.

Propane Torch - A canister of liquefied propane gas (LPG) with hose, nozzle, and pilot light produces a very hot flame but with little lasting effect if fuels are moist. This is generally a hand-held device, but it can also be mounted in the back of a trailer or pickup. This type of torch projects flames up to 4 feet. LPG is classified as a "flammable gas."

Very Pistol - This is a hand pistol varying in diameter from 12 gauge to 25 mm. Most effective in *dry*, light, continuous ground fuels, the Very pistol, allows remote ignition. Burning time is approximately 8 seconds. Effective range varies from 50 to 200 feet, depending on the size of the ordnance and whether fired uphill or downhill. The Very pistol requires special training; (follow agency policy) and is not advised for aerial application from helicopters due to shots being fired into rotor arc, skid system and/or within the helicopter itself. Ammunition is classified as a "Class C Explosive."

Flare Pen - This is a hand-held cylindrical device resembling an over-sized pen that launches small flares using a spring or trigger device. It is best suited for *dry*, light, continuous ground fuels, allows remote ignition, has a burning time of approximately 5 seconds, and an effective range from 50 to 150 feet, depending on the size of the ordnance and whether fired uphill or downhill. This device requires special training (follow agency policy) and is not recommended for aerial application from helicopters due to shots being fired into rotor arc, skid system and/or within the helicopter itself. Ammunition is classified as a "Class C Explosive."

Fusee Launcher - This device consists of a launch tube with hose and an air compressor that uses 100 to 130 psi of pressure to launch standard fusees. Best suited in *dry*, light continuous ground fuels. Burns approximately 20 minutes depending on size. Launches fusees approximately 600 feet depending on terrain and air pressure setting. This device requires special training (follow agency policy) and is classified as a "flammable solid" by the DOT.

Blivet - This is a sealed plastic bag containing a jelled fuel mixture, typically diesel and gasoline. The blivet works best in heavy and slightly damp fuels such as slash or piles. It is useful in rolling and hilly terrain. Plastic bags of jelled fuel are primarily hand placed, but can be thrown. If hand placed, they should be lit with a fuse. They can be equipped with a section of igniter cord, lit and hand thrown. Jelled gasoline/diesel and igniter cord are subject to 49 CFR Part 397 (Hazardous Materials).

Power Flame Thrower - (Power flame-thrower sold as Terra Torch TM by Firecon, model 6430 portable torch, and Hot Shot TM by Simplex, model 6410) Similar to a military flame-thrower, the device has a mixing and storage tank, positive displacement pump, and a firing wand. Jelled gas is sent through the pump and ignited by a propane (LPG) lighter. It projects hot, high-volume flaming jelled fuel approximately 20 to 150 feet, depending on terrain and pump pressure. Fuels are coated, producing a lasting effect. This device requires special training (follow agency policy). Jelled gasoline/diesel is classified as a "flammable liquid."

Canisters - (Canister backfiring devices sold as Burnol TM.) Burnol TM backfiring devices consist of pint or quart sized metal containers of gelled fuel (napalm) and a No. 6 fuse cap with a 90-second black-powder core safety fuse. These are hand thrown devices. Upon detonation, the device propels burning napalm over an open circular area of approximately 20-30 feet in diameter. The gel-like petroleum clings to forest fuels and burns from 4 to 10 minutes. These devices require special training and certification (follow agency policy). Fuse caps are classified as "Class C Explosives," and canisters of napalm are classified as "flammable liquids."

Aerial Ignition Systems

Of the many methods available for starting ignition, setting fires from the air offers many benefits over those requiring ignition from the ground. Among the benefits are (1) less chance of ground personnel being trapped in a fire, (2) larger areas can be burned when conditions are best, (3) fewer personnel and less time needed to accomplish the tasks, and (4) in many situations, costs are lowered.

There are many factors that should be considered in making a selection of an aerial ignition system, including the size of the area to be burned, phase of the fire, values at risk, strategy, topography, fuel and site conditions, availability of different aerial ignition systems, trained and qualified personnel, carded aircraft and pilots, and economic concerns. No one system will completely satisfy all of these factors in every instance.

Helitorch - This device is mounted externally on a helicopter. The pilot controls placement of the burning fuel. This device uses jelled gasoline, produces large amounts of fire in a short period of time, and will burn standing brush and other fuel types with little or no ground fuels. It ignites fuels with higher fuel moistures expanding the prescription window. Use of this device is limited to daylight hours and requires a complex firing organization and special training (follow agency policy). Jelled gasoline/diesel is classified as a "flammable liquid."

Plastic Sphere Dispenser - (ping pong ball machine). This device is mounted in the rear door opening of a helicopter. The device dispenses polystyrene spheres (similar to the size and composition of ping pong balls) filled with potassium permanganate crystals. The machine injects the polystyrene spheres with ethylene glycol and releases the spheres which drop to the ground. An exothermic reaction occurs and the spheres ignite within 20 to 30 seconds. The device is most effective in dry, light, and open canopy fuel. However, some users indicate it works well for underburning in canopy fuels as the balls fall through the canopy to ignite the ground fuels. It produces a relatively low intensity fire from each ignition source.

SECTION 4 - MECHANICAL EQUIPMENT

Mechanical equipment can be very effective in fire suppression work and will normally replace the efforts of many people on the fireline. Cost benefits can be realized through the use of machines if good management practices are followed. To accomplish good management practices one must have a knowledge of mechanical equipment and devote enough time to the management of the equipment on the fire.

The three kinds of mechanical equipment covered in this section are dozers, tractor/plows, and engines.

Many of the fireline construction and safety principles covered in Section 1 also apply to the use of mechanical equipment.

DOZERS

Dozers are effective firefighting tools if they are used correctly. They are costly to operate and require good operators, good supervision, and adequate service and repair. However, in excessively rocky areas and in some dense timber stands, especially with many large trees, their progress will be drastically slowed. When they are needed to pioneer ahead of a tractor/plow or crew, they are indispensable. In this capacity they do the clearing work so that the plow or crew can build the line as they follow.

Dozers will come with various types of blades and control systems. There are two types of blade control systems used on dozers. These are cable and hydraulic. Almost all dozers produced during the past 30 years will have the hydraulic system. Cable systems were common before that period; however, there are still some of the older dozers with cable systems in use.

Cable controlled systems are best used in light fuels for light scarification of soil, for finishing fireline, and for road grading.

Hydraulic systems can exert pressure down as well as raise the blade, thus are best used for digging in hard ground, cutting through roots, cross ditching or water barring, digging sumps and pits, and downslope breaking action. The hydraulic control is also helpful if the dozer becomes high centered or stuck and the terrain needs to be built up under the tracks.

The three common types of blades and their best uses in fire suppression are:

1. The straight blade. It can usually be angled and push soil to either side of the dozer. This is not true with the other types. Thus, the best uses for straight blades are: Pioneering and finishing fireline, cross ditching, and road construction and maintenance.
2. The "U" blade. Best used for pioneering fireline, sump digging, and earth moving (as in road construction).
3. Brush blade. The best uses for brush blades are pioneering in brush, clearing and piling slash, mopup work, and certain rehabilitation work.

Table 1 discusses the types of dozers by size. It divides the various models into three size groups. Consider the age and condition of different dozers. For example, the newer Caterpillar D-5's can match the performance characteristics of the older D-6's, and so forth.

Table 1 – Comparisons of Dozers Used For Fireline Construction

Make	Size	Weight	Blade Width	Horse Power	Min. Ground Clearance
Large dozers (Type 1)					
Caterpillar	D-9H	95,000	16'	410	
Caterpillar	D-8K	69,000	15'6"	300	
Caterpillar	D-7G	52,000	15'7"	200	
International	TD-25L	69,780	13'2"	310	
Terex	82-30B	61,000	12'3"	260	18.25"
Terex	82-20B	42,000	11'5"	205	17"
Terex	82-30	54,000	12'3"	225	18.25"
Komatsu	D-155A-1	76,000	13'6"	320	20"
Komatsu	D85A-12	40,000	11'10"	180	16"
Medium dozers (Type 2)					
Case	1450	30,000	10'	130	15"
Case	1150B	25,000		125	15"
Caterpillar	D-6D	31,000	13'8"	140	
International	TD-30E	47,525	11'5"	157	19"
John Deere					
JD-750/6520		29,335	12'2"	110	14"
John Deere					
JD-750/6525		28,985	9'7"	110	14"
Komatsu	D65E-6	36,000	11'2"	155	16"
Komatsu	D53A-16	25,000	12'2"	110	13"
Light dozers (Type 3)					
Case	350	8,000	6'8"	39	11"
Caterpillar	D-3	14,000	7'11"	62	
Caterpillar	D-4	20,000	8'-10'	75	
International	TD-8E	16,617	12'5"	56	14"
International	TD-7E	13,632	12'1"	48	12"
John Deere					
JD-350c/6300		10,300	7'6"	42	13"
John Deere					
JD-450c/6405		14,230	7'6"	65	14"
Komatsu	D45-A	18,000	10'4"	90	14"
Komatsu	D31P-16	15,000	8'2"	63	14"

Some conditions which limit dozer use are steep slopes, heavy fuels, rock outcroppings, bogs or swamps, and fragile soils. The use of dozers on side hills with soft fragile soils can be hazardous, and will increase erosion potential.

Light dozers (Type 3) are effective in building fireline in light fuels on level to moderate terrain. They perform best in soil with few rocks, and in wet soil conditions, especially when equipped with wide tracks. They're maneuverable in close quarters and generally do less damage to the environment. They also can be very useful in mopup operations.

Medium-sized dozers (Type 2) are generally the best all-around size for fireline construction as they are maneuverable and perform well on moderately steep slopes. They will handle the average fuel and terrain conditions in the mountainous areas and when fitted with wide tracks perform well in wet soil conditions.

Heavy dozers (Type 1) are generally too big for many fireline construction situations. They are hard to maneuver in close quarters, especially in steep terrain. They are best assigned as lead dozers to pioneer in heavy fuels on level to moderate terrain. Heavy dozers will have difficulty in wet ground unless fitted with extra wide tracks. On standard tracks their bulk weight more that offsets the hold up surface of the tracks, and once these large machines are stuck, it is a major job to free them.

As a general guideline, dozers should not be operated across slopes (sidehill) greater than 45 percent, uphill on slopes greater than 55 percent, or downhill on slopes greater than 75 percent (see Figure 1).

Figure 1 – Guideline For Maximum Percent Slope Dozer Operation

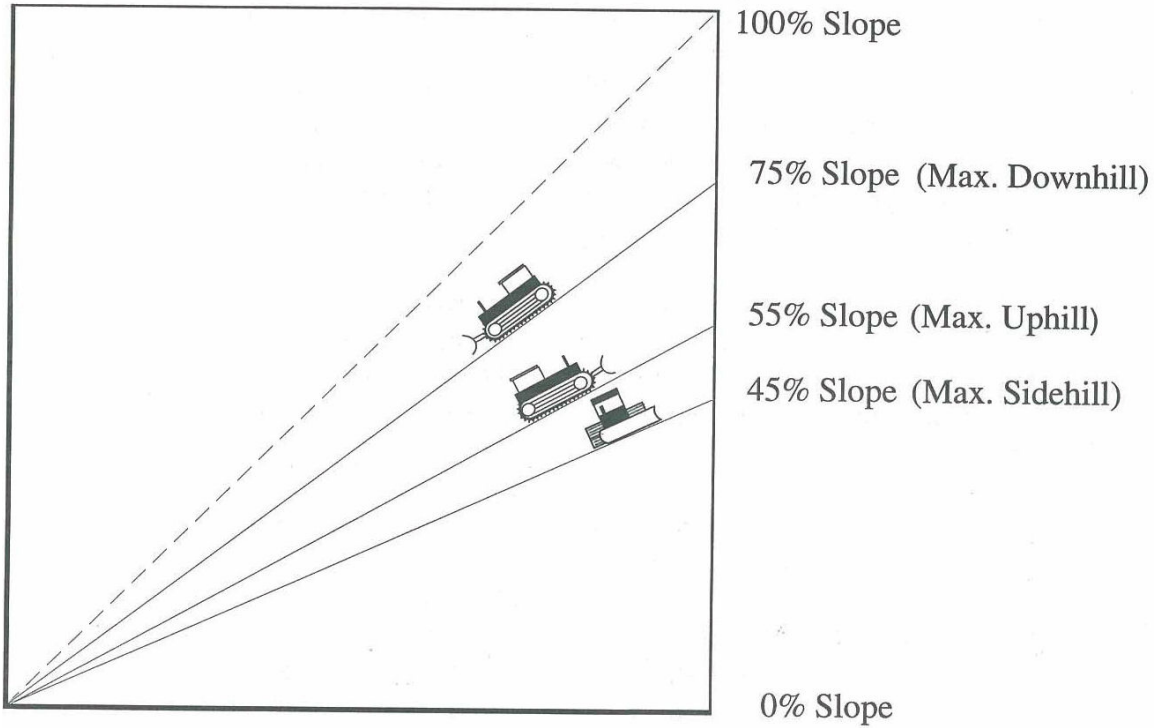

Percent slope is determined by the vertical distance (rise) divided by horizontal distance (run) multiplied by 100 (see Figure 2).

Figure 2 – Calculation of Percent (%) Slope

$$\% \text{ Slope} = \frac{\text{RISE}}{\text{RUN}} \times 100$$

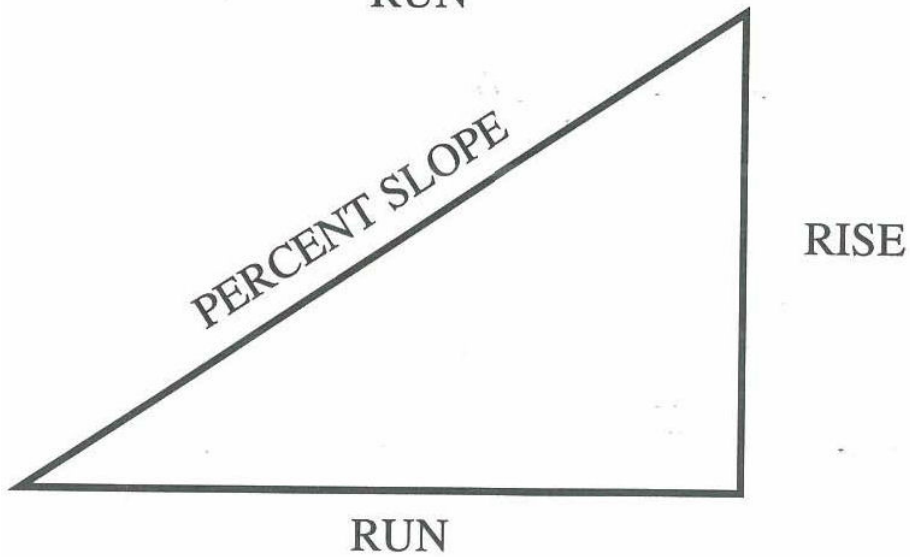

An easy method to determine percent slope is with the use of a slope meter (see Figure 3).

Figure 3 – Slope Meter

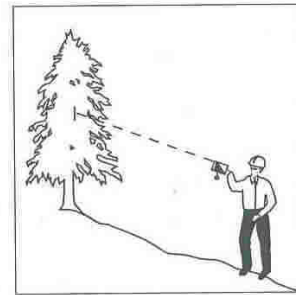
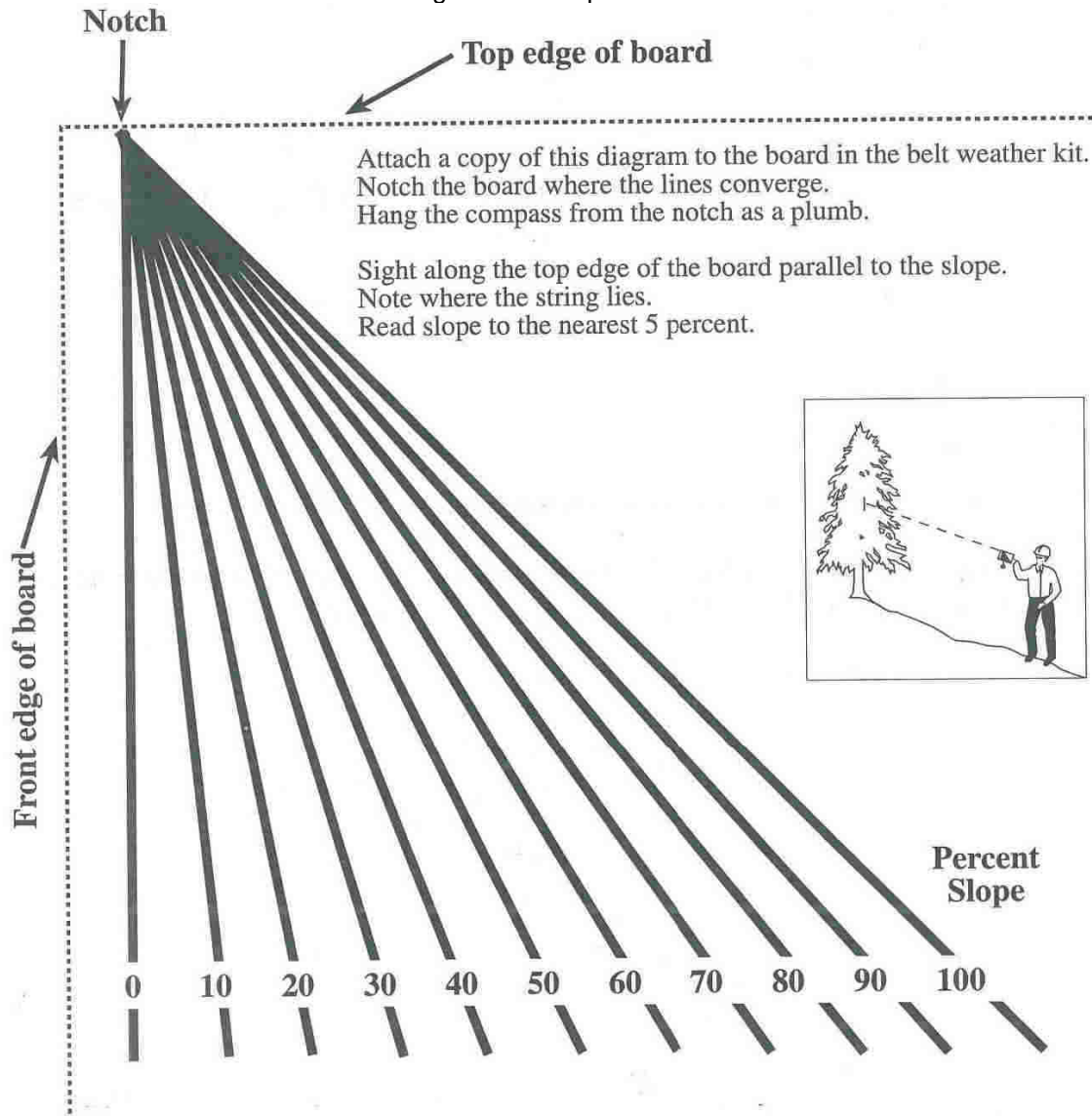

Clinometers or abney levels are instruments that can be used to measure percent slope (see Figure 4).

Figure 4 – Instruments to Measure Percent Slope

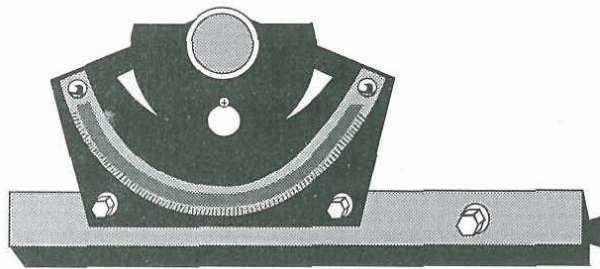

Abney Level

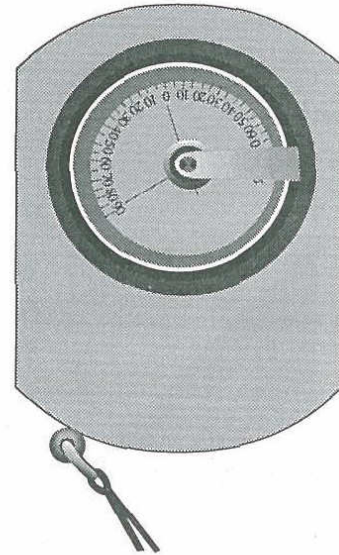

Clinometer

To use the clinometer hold it to your eye and with both eyes open, look simultaneously through the lens and alongside the housing. A horizontal sighting line will appear. Raise or lower the clinometer (by tilting your head) to place the sighting line at the top or bottom of the object. Read the percent slope number closest to the sighting line.

Operate the abney level similarly to the clinometer, but rotate the outside scale forward or backward to align the bubble inside the instrument rather than tilting your head. Read the number from the outside percent slope scale.

Clinometers and Topographic Abney Levels can be used to measure slope, height of objects, and vertical angles (see Figure 5).

Figure 5 – Measurements With Clinometer or Abney Level

Measurements

Height

For height measurement, choose a scale and a convenient baseline distance. Standing at the baseline distance, sight the tip of the object and read the scale; sight the bottom of the object and read the scale. Add the two scale readings together and multiply this total reading by the baseline distance. This is the object's height.

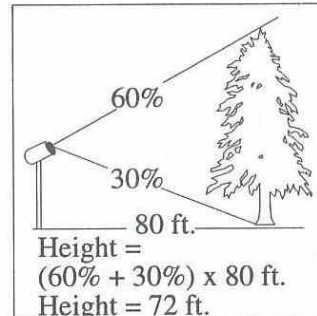

Slope

Sight upslope or downslope on the object at eye level. Read directly from the percent or degree scale.

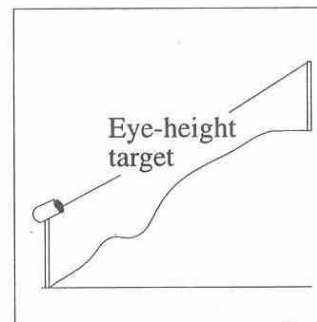

Vertical Angles

Sight upslope or downslope on the object at eye level. Read directly from the degree scale.

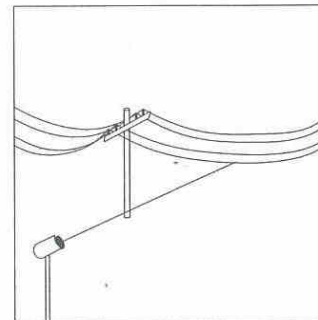

Table 2 provides single pass line construction rates in chains per hour for several variables. The table was developed from a series of field tests.

Some generalities that can be concluded from Table 2 are: 1) production rates drop as the fuel loadings increase and 2) slope has an effect on production rates, particularly traveling upgrade, and some dozer sizes are better suited for select jobs than others.

Table 2 – FIRELINE PRODUCTION RATES (SINGLE PASS) FOR DOZERS MANUFACTURED SINCE 1975

Fire behavior fuel model	Slope class 1 (0% -25%)		Slope class 2 (26% -40%)		Slope class 3 (41% -55%)	
	Up	Down	Up	Down	Up	Down
Chains per Hour						
Small dozers (Type 3)						
1, 2, 3	63	88	36	88	14	16
4	22	29	12	30	3	22
5	63	88	36	88	14	61
6	39	59	22	62	8	42
7	39	52	22	56	8	35
8	63	88	36	88	14	16
9, 11, 12	22	30	12	30	3	11
Medium dozers (Type 2)						
1, 2, 3	88	118	58	112	35	73
4	32	47	18	53	5	31
5	88	118	58	112	35	73
6	51	75	26	78	9	48
7	51	75	27	78	9	48
8	88	118	58	112	35	73
9, 11, 12	32	47	18	53	5	31
10, 13	17	23	10	25	3	11
Large dozers (Type 1)						
1, 2, 3	91	124	62	118	35	83
4	43	60	27	62	12	40
5	91	124	62	118	35	83
6, 7	63	91	41	90	22	57
8	91	124	62	118	35	83
9, 11, 12	43	60	27	62	12	40
10, 13	27	38	15	34	4	16

Line location is as important for dozers as for handtools, and the same principles of width, depth, and location apply. Locate the line in accordance with the fire control strategy, vegetation, and terrain. The line should be located well ahead of the dozers but not so far that the line location would need to be changed by the time the dozers get there. The locator should check periodically with the spotter or operator of the lead dozer or with the dozer boss to advise them of what is ahead.

Locations where dozers cannot work effectively should be avoided and completed with handtools. These locations would include areas of large rocks, rock outcrops, excessively steep terrain, or other limitations to the use of dozers. Trench undercut lines, and treat all hazards in the same manner as hand line construction and mopup.

The principles of direct, parallel, and indirect attack also apply to dozer line construction (see pages 16-17); and, as a general rule, all dozed material should be cast outside the line and scattered. In a very few instances the dozer might be used on very small fires to push the burning edge into the fire area all the way around the perimeter. This is not a highly recommended practice.

Dozers are extremely effective tools for building firelines, particularly in heavy fuels and brush. They must be followed with handtools to finish the line, to burn out where necessary, to hold the fire within the line, and to combat slopovers and spot fires.

Once the fireline is built, it is necessary to begin the mopup from the fire edge toward the center of the fire, and this operation requires handtools. Often, engines or hose lines can be used to assist with holding action and mopup. Much will depend on the kind and volume of fuels. Dozers can be used to a limited extent on mopup operations.

Often it is practical and desirable to build the dozer line where it will serve as an access road for engines and the movement of crews. Grade along the line then becomes important so that four wheel drive vehicles can travel. This use is very valuable but should not dictate the location of the fireline. The location for fire control purposes must take precedence.

It may be necessary for dozers to clear out safety areas. These should be built well in advance of probable need.

Dozer organizations will vary with the size of the fire, the kind and amount of fuels, the topography, the practice in that locality, and the personnel available. On a large fire with several dozers a dozer boss or dozer strike team leader will normally supervise dozer operations (see Figure 6).

Figure 6 – Dozer Organization On A Large Fire

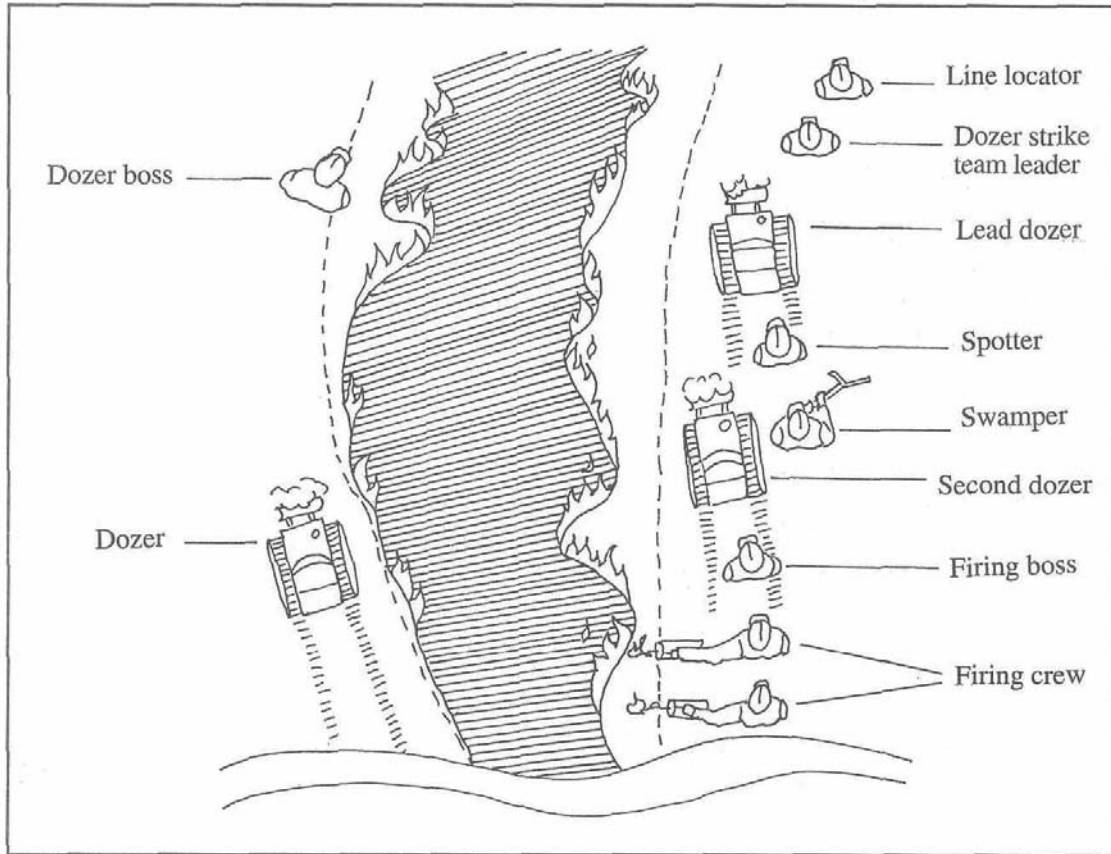

In heavy going a spotter, swamper, line locator, and hand crew may be assigned to assist with dozer line construction. Because of the danger from rolling rocks and/or debris, no personnel should work directly below a dozer.

At least one person should be assigned to each dozer as a swamper. The contractor will normally provide a swamper for contract dozers. The swamper is to:

- Handle the winch line and choker, help change blade positions, assist with the maintenance, and otherwise assist the operator of the dozer.
- Communicate by hand signals with the dozer operator.

- Cut away projecting branches and sticks that may jam the machine and cause damage or endanger the operator, to remove rocks and debris from the machine on signal from the operator, and to cut with an ax or chain saw where necessary to move logs and tangled windfalls.
- Work as a spotter if one is not assigned or as a contact between the operator and the spotter.
- Act as an alternate operator.

Since mechanical equipment is generally noisy and it's difficult for operators to hear other personnel in the area, a simple but effective communications system can be accomplished through the use of hand signals and other signals (see Figure 7).

Figure 7 – Dozer Hand Signals

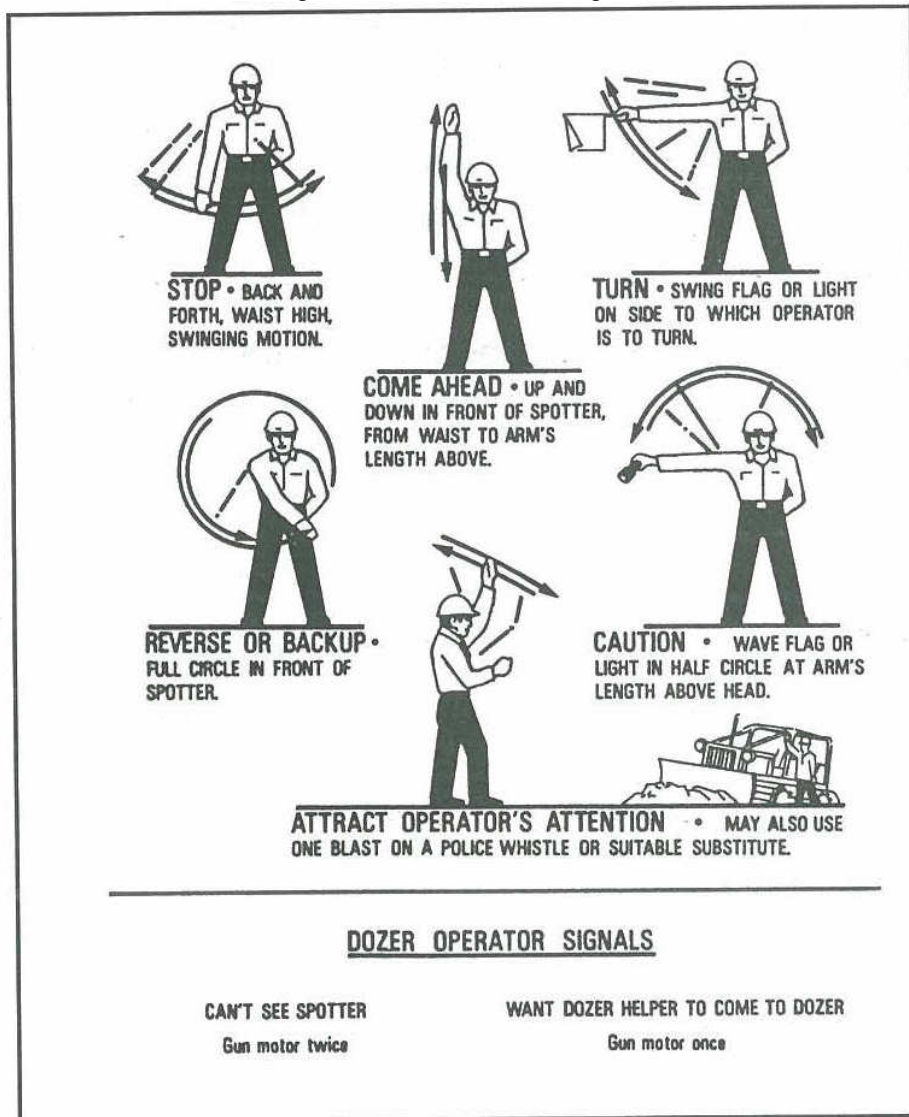

By gunning the dozer motor twice, the operator can signal that he cannot see the spotter, and by gunning the motor once, he can signal that he wants the helper to come to the dozer.

The following are good dozer line construction principles:

1. Utilize anchor points and LCES (lookouts, communications, escape routes, and safety zones.)
2. All unburned fuels should be cast away from the fireline and scattered to the extent possible.
3. Where both soil and debris must unavoidably be pushed to the inside, spread and scatter this material well back into the burn. In fuel types with down timber it may be best to use power saws ahead of the lead dozer to "buck" the material.
4. Chain saw crews should be closely supervised, kept well ahead of the dozer, and avoid doing work the dozer can do. Saw crews are not needed if the lead dozer is large enough to do the job or if it can do the job without creating excessively large piles of debris.
5. Snags can be quickly felled by dozers. Where snag felling is hazardous to dozers, the job should be done by felling crews. Local practices will vary for different sections of the country.
6. Consult with the operator (both operator competence and dozer capability) before assigning dozer work in steep terrain and contouring sideslopes.

7. Generally, two dozers should work together in pairs or tandem when constructing fireline. They can reinforce each other and assist each other if one dozer needs help. The largest machine or the one in the best condition should serve as the lead dozer. Neither machine should be operated below the other on slopes or too close together because of the danger of rolling and falling material. If a narrow fireline is needed the lead dozer pioneers the line by doing the rough clearing job and the second dozer cleans up the line. If a wider fireline is needed both dozers may be doing a substantial amount of clearing. However, the second dozer still cleans up the line.

Figure 8 – Tandem Dozers Constructing a Wide Fireline

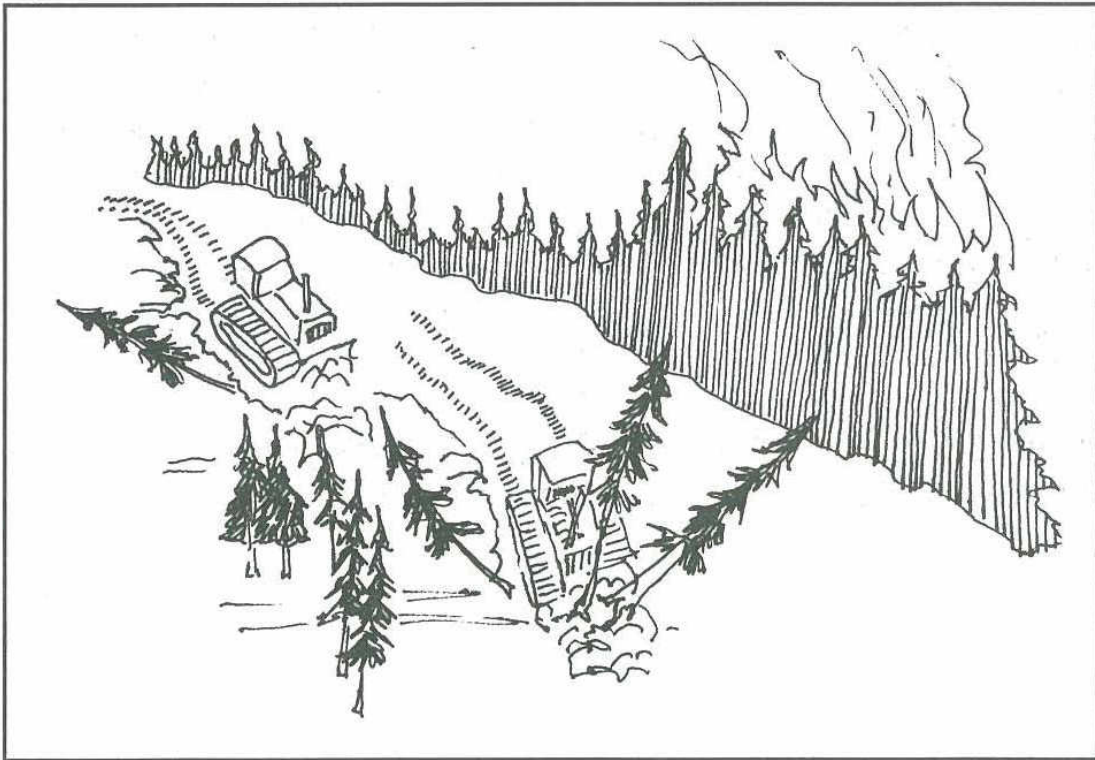

8. The line may be wider in some sections than in others depending on the job it is intended to do. There must be a reason for extra width of line. It may be because the brush is tall and thick, because the canopy needs to be opened up, or to keep the crew from being scorched during burnout.

The line should be wide enough to hold the fire; *usually 1-1/2 times the height of the fuel in brush and not less than one-half the height of the fuel in timber.*

It is often impractical to make it wide enough to withstand a run of the fire. Enough area must be burned out from the line toward the fire to contain it and any spotting.

9. Use a cleanup crew behind the dozer to speed up the line construction and to make it secure. The job of the cleanup crew is to prepare the line for burnout by reducing the kind and amount of fuel along the edge of the line so that the chances of radiated heat and mass transport across the line will be reduced. The job is accomplished by:

- Felling snags on both sides of the line.
- Felling leaners.
- Breaking up, tearing apart, flattening, and dispersing accumulations of fuel close to the line.
- Lopping and scattering tops and branches and cleaning up the lower stems of standing trees by cutting off limbs, moss, and vines.
- Making sure the line is continuous and free of surface fuels.

Normally, three to six people are needed in a clean up crew plus a squad boss. They may be part of the burnout crew if the cleanup job is light.

The main point here is that hand tools are needed to follow the dozers in any type of fuel to make sure the line is ready to bum out and hold. The cleanup crew must stay away from the immediate area around the dozers, since they are constantly backing and maneuvering.

10. The burnout crew may be part of a combination crew that does both cleanup and burnout. On larger fires it will be separate and supervised by a squad boss or a crew boss according to its size.

If burning out follows the dozers, it should not follow so close that the firing will handicap the dozer's operation or jeopardize the line construction and cleanup.

11. Proper supervision must be provided for hired equipment. Proper organization and supervision are the keys to successful operation of equipment.

12. Provision must be made for servicing equipment as soon as the equipment moves onto the fire. These are expensive machines, and they cannot be operated long without servicing.

13. Dozers and tractor/plows must be properly equipped:

- They should have canopies of sufficient strength to withstand rolling over and to protect operators from falling material.
- The dozers should be armored underneath.
- They should have functioning lights, both front and rear when it is dark.
- They should have seat belts.
- They should have a fire extinguisher and shovel.
- They should have a properly functioning spark arrestor.
- Operators must be supplied with required personal protective equipment, including fire shelters. It may be necessary to instruct the operator on the proper use of the fire shelter.

TRACTOR/PLOW

Plows are pulled by 4-wheel drive vehicles and by dozers. For the purpose of this document, a plow pulled by a dozer will be called a tractor/plow or a tractor/plow unit. There are a number of different kinds and sizes, but the ones used with tractors are in the majority and generally are the most satisfactory. In the southern pine flat woods, plows outnumber engines because they are so effective. The medium units are the most numerous. These are pulled by the TD-9, HD-6, and D-4 size class dozers. Light units include TD-6 and D-2 size class dozers. Heavy units include TD-14 and D-6 size class dozers.

Plows are a principal wildland fire tool in the flat woods and coastal plains of the South, Southeast, and Florida. They are generally used in the Midwest and the Lake States and the Northeast. They are in limited use in the Southwest. The fireline plow is best used in fuel types that can be traversed without too much interference from standing timber, where the topography is more or less level to rolling, and where the soils are generally sandy or friable with a minimum of rock. Rocky soils are a deterrent to plows. As the slope increases, the efficiency of the plow decreases.

Since the plow is pulled by a dozer, the fuel type must allow access to that size dozer. Otherwise, the plow unit must be preceded by a dozer and/or a saw crew. Tractor/plow units can usually walk down trees up to five inches in diameter if they are not too closely spaced.

In suitable fuels and soils, most tractor/plows are able to construct line at a maximum of three mph (240 chains/hr). The speed will vary considerably below the three mph on account of soils, stumps, boggy sections, trees, and other obstructions.

Line construction and line location principles are the same for plows as for any other method. The depth of plowing should be as shallow as possible and yet should obtain a clean line down to mineral soil. The shallow line is equally as effective as the deeper one as long as it is clean and continuous. The shallow line puts less drag on the tractor so that plowing is faster, the line is less restrictive to wheel traffic, and less erosion is caused on slopes. The depth should be adjusted while the plow is in motion and should be frequently checked if it is hydraulically operated. Since burning out is the usual practice in line construction, the plowed line should be as straight as possible. The line should be adjusted as necessary to keep stumps, snags, fuel accumulations, and other hazards outside the line.

The principles of operating a single tractor/plow are much the same as operating with teams of two or more tractor/plows. However, two tractor/plows are the optimum number per team.

Most of the time, a tractor/plow crew consists of two people, one operating and the other swamping or firing. A holding crew of one or more people may be required to clean up, hold the line, and chase spot fires, depending on the fuel type and conditions (see Figure 9). If an engine is available, these jobs are accomplished by the engine crew.

Figure 9 - Tractor/plow Crew Organization.

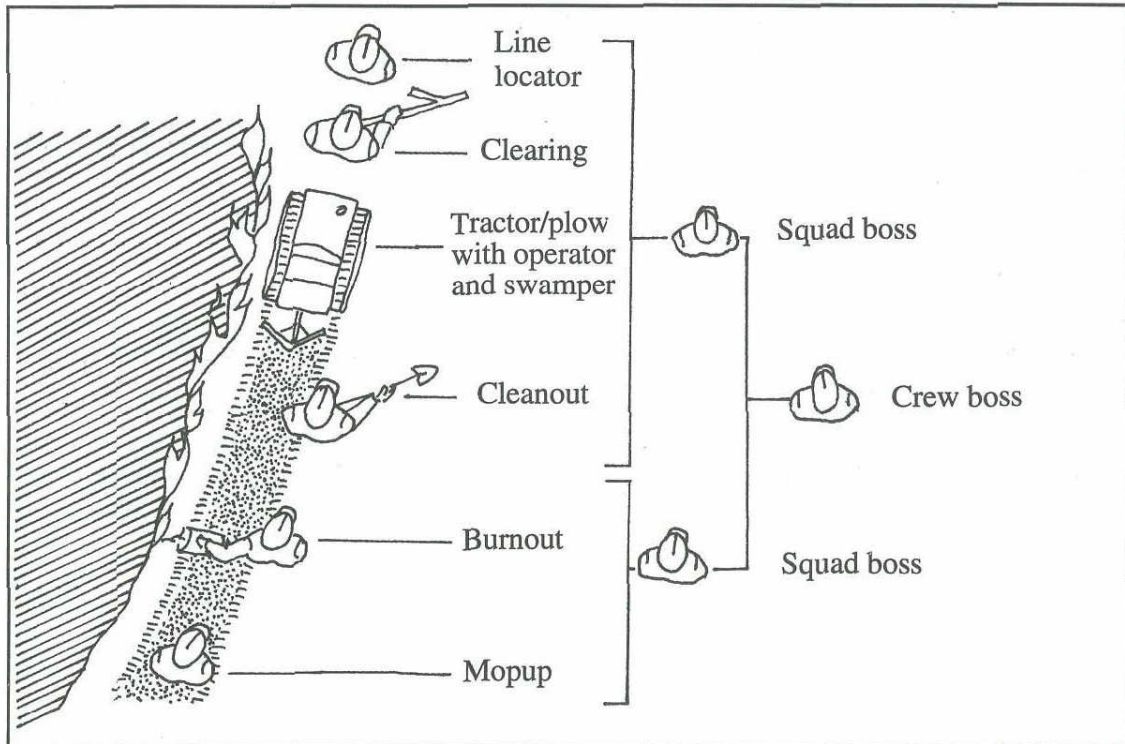

Timing is important in successful plow operation (see Figure 10). Timing must be adjusted to:

1. Rate of fire spread
2. Plowing rate
3. Burnout time and extent of burnout
4. Distance from the fire to:
 - heavy or lighter fuels
 - plantations, buildings, etc.
 - natural barriers, swamps, ect.

Figure 10 – Timing Is Important In Successful Plow Operation

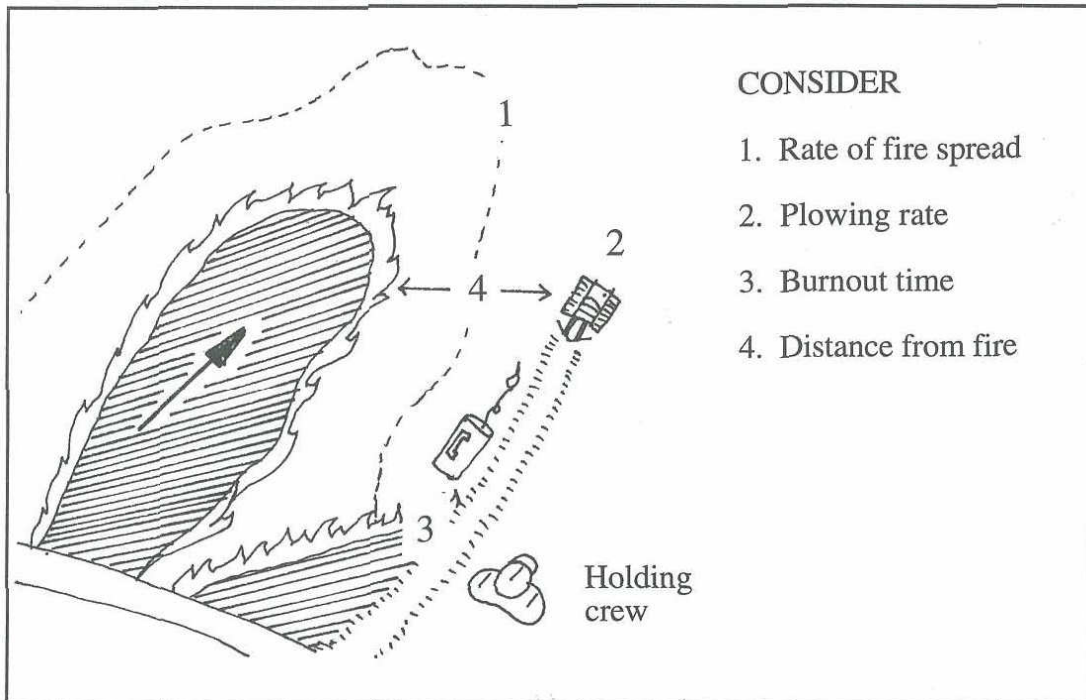

In brush and scrub timber or light fuels and where stumps are readily visible, it is best to plow as close to the fire as possible and as fast as possible. In heavier fuels the best tactic is to give the fire some room and to burn out from the line.

There is a general guideline in Florida: "If it's worth plowing, it's worth burning out."

Normally, each tractor/plow should take a different portion of the line. This is particularly true if enough engines and/or personnel are available to follow up each tractor/plow.

On more difficult fires, the best results are usually obtained by working plow units in teams, particularly if it is difficult to construct and hold the line.

Two parallel plowed lines are made to obtain the width needed for holding. The rolled-out turf of each line should just touch the brim of the adjacent line. The outside plow follows a short distance behind the inside plow.

In difficult line construction, the units are operated in tandem (see Figure 11). The first unit (usually a dozer without plow) takes out obstructions such as big brush and snags and as much surface as time will allow. The second unit makes a clean line. They must work as a team, adjusting the work load between them.

Figure 11 – In Tandem Operations, The First Unit (Dozer) Clears The Line, And The Second Unit Plows The Line.

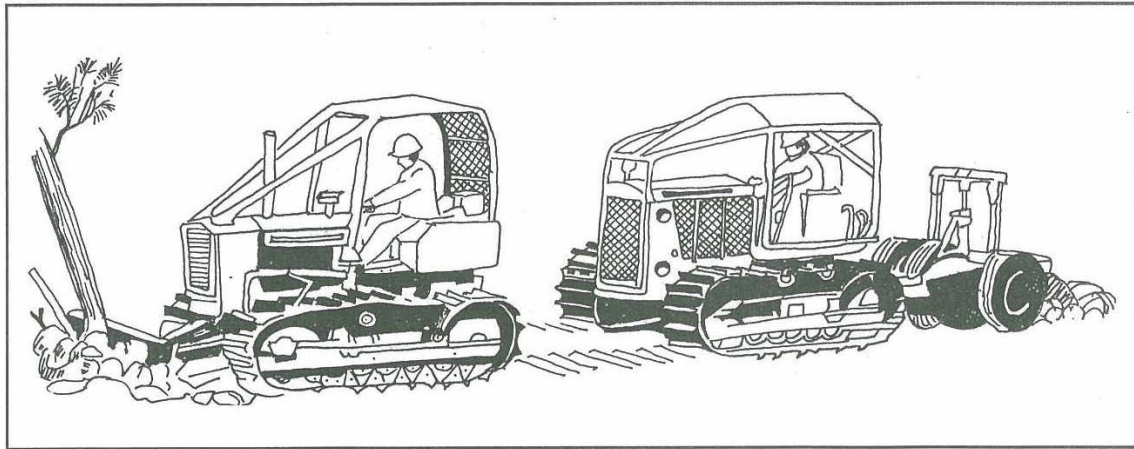

In trees and heavy brush, the heaviest dozer takes the lead to walk down obstructions or push them to the outside. Material that has no fire in it is always pushed to the outside. If the difficulty is frequent bogging, the favorite method is to send the smaller dozer in the lead to "feel out" the line. It is much easier for the heavier unit to pull the smaller one out of a bog than vice versa. Both should strive to stay in sight of each other so that they can immediately give aid to each other.

If using dozers and plows as described above, only a dozer would be placed in the lead. There are some situations when a dozer is needed, because a tractor/plow alone cannot do the job.

Safety is a very big concern in any fire job and certainly in mechanical equipment operations. Here are some safety practices that you should remember.

1. Keep crews a safe distance from working mechanical equipment.
2. Never work immediately downslope from mechanical equipment.
3. Never mount or dismount while mechanical equipment is moving.
4. Don't allow riders on mechanical equipment.
5. Attract the operator's attention before approaching mechanical equipment.
6. Do not allow anyone to rest or sleep near heavy equipment.
7. Drop dozer blades to the ground when equipment is idling or stopped.
8. Use hand signals between operator and crew.
9. Limit an operator's tour of duty to 12 hours per day.
10. Ensure that personal safety gear is provided and used.
11. Instruct the operator on the proper use of a fire shelter if necessary.
12. The dozer operator has the final authority on whether the assigned dozer work can be completed.
13. The dozer boss should inform the appropriate supervisor upon entering and leaving the assigned work area.

ENGINES

Engines can be very effective for control of wildland fire. Their uses include:

- Direct, parallel, and indirect attack.
- Patrolling fireline.
- Hot spotting to aid in direct attack.
- Supplying water and additives through hose lays.
- Supplying water for backpack pumps or other units.
- Mopup operations.
- Ground application of fire retardants.
- Protection of structures and improvements threatened by wildfire.

Like any firefighting unit on the line, firefighters and equipment must be properly managed to safely and effectively accomplish the suppression job. Situations where engines probably should not be used include:

- Fuels are too heavy to permit travel along the fireline.
- Poor access to and from the fireline.
- Terrain is too rugged for vehicle travel.
- If access is poor and terrain is restrictive consider stationary pumping operation.
- Water supply is too far from the fire for effective operations.
- Support units for engines are not available.
- Attempting to control the fronts of fast spreading fires.

It is important that good management and safety practices for engines be followed. Some of these are listed below.

1. Obey all traffic regulations en route to fires. More serious engine accidents probably occur on the way to the fire than on the fireline itself.
2. Mark vehicles parked on improved roads with flags, flares, and so forth. Also, normal traffic should be regulated on these roads.
3. Require that engine crews include a driver, hose puller, and nozzle operator. These are minimum required positions for many agencies.
4. Use trained and experienced people on engines, particularly during the control phase of fire suppression activities. There might be opportunities for training others later.
5. Work the flanks rather than making a frontal assault. This is a common sense practice for any fireline unit.
6. Never block a road. Allow room for traffic to pass.
7. Keep engines headed in the right direction. Back in for quick egress if necessary. This is particularly important where turning around could be difficult.
8. Keep engines on the opposite side of roads from the oncoming fire. If an engine is stalled or abandoned, it will have a better chance of surviving a flaming front.
9. Plan an ample water supply for engines. It might require some road work to make a water source more accessible, or a water tender might be needed to transport water over long distances.
10. Coordinate units so all do not run out of water at the same time. A rotation system should be set up to handle emergency needs for water.
11. Provide adequate supervision and communications for engines. This is another common sense item that applies to all firefighting units.
12. Use buildings or natural barriers for protection.
13. Do not park at the top of draws, chimneys, saddles or natural funnels.

14. Try to work engines together.
15. Watch for hazardous materials stored in houses and garages, such as gasoline and pesticides.
16. Look for fire hydrants that have "disappeared" into overgrown brush.
17. Check reliability of hydrants.
18. Be cautious around propane tanks adjacent to structures.
19. Be extremely cautious around utilities (power lines, underground gas lines, septic tanks, cisterns). Care must be taken when operating heavy equipment and engines around structures due to the presence of these. Septic tanks and cisterns may collapse under the weight of machinery.

Methods of Attack

There are three methods of attack used on wildland fires; 1) direct, 2) parallel, and 3) indirect. They are covered in Section 1 - Fire Suppression Principles, pages 16 and 17.

Engines are invaluable when used for direct attack, especially in light fuels such as grass. The engine provides the firefighter with the mobility and flexibility in fire suppression by providing water, retardant or foam where needed on the fire.

When using engines in direct attack consider the terrain, point of attack, escape routes, fuel types, fire intensity, rate of spread, and the capabilities of the crews and equipment.

There are several tactical uses of engines in direct attack. They are mobile, tandem, pincer, envelopment, inside-out, and stationary.

Mobile Attack

When terrain and conditions allow, the mobile attack is the fastest and most effective method (see Figure 12). The engine is driven along the fire's edge while a nozzle operator applies water parallel to the fire and at the base of the flame. The nozzle operator should be in full view of the driver at all times. Follow-up action will be taken with hose, hand tools, or both.

Figure 12 – Mobile Attack

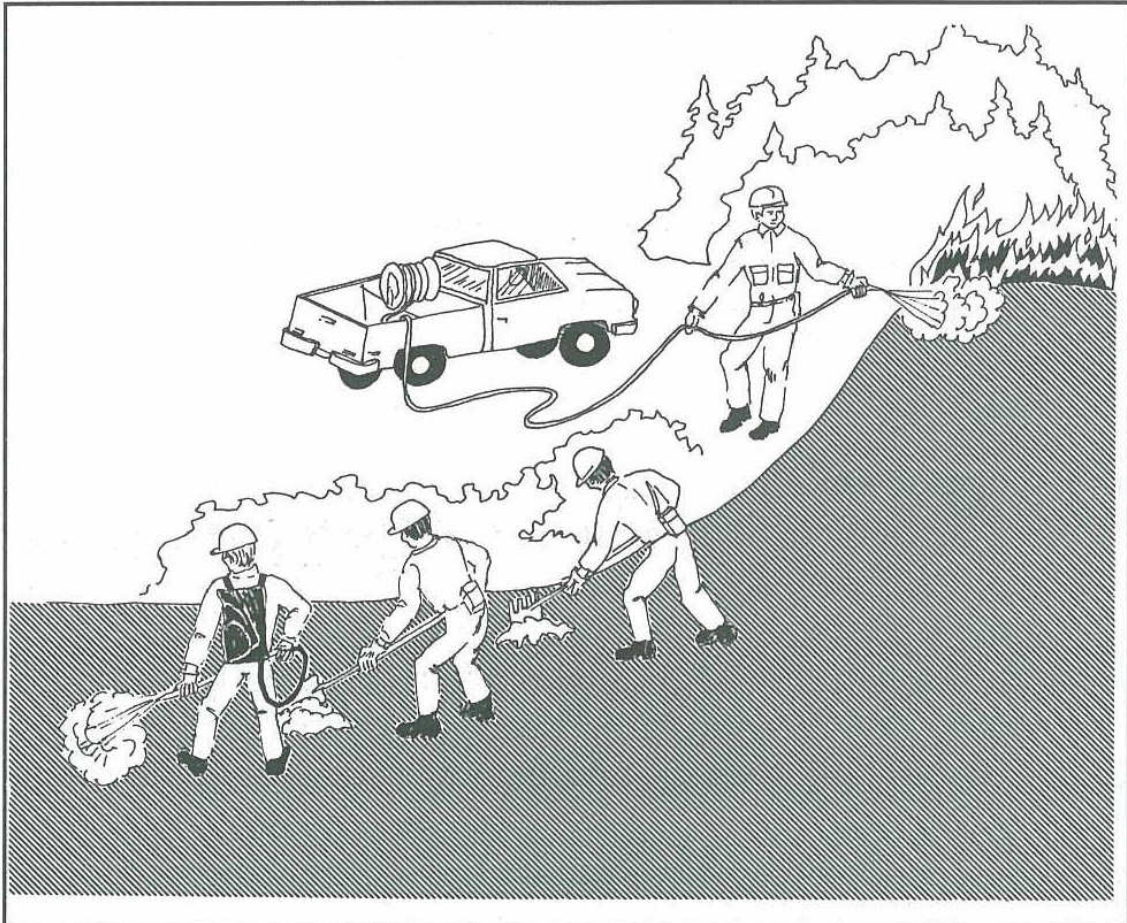

The mobile attack requires an engine with the ability to make a running attack (pump and roll). Generally, all wheel drive engines with a short wheel base are better suited for off road travel.

In heavier fuels or on a hotter burning fire, two nozzle operators can be used with a mobile attack. The first nozzle operator knocks down the hot spots and the second nozzle operator totally extinguishes the fire.

Tandem Tactic

Two engines can be used in tandem with a mobile attack (see Figure 13). Again the first engine hits the hot spots and the second engine follows up totally extinguishing the fire. Two engines working together make a safer operation because one can help the other if it gets stuck, broken down, etc.

Figure 13 Tandem Engines

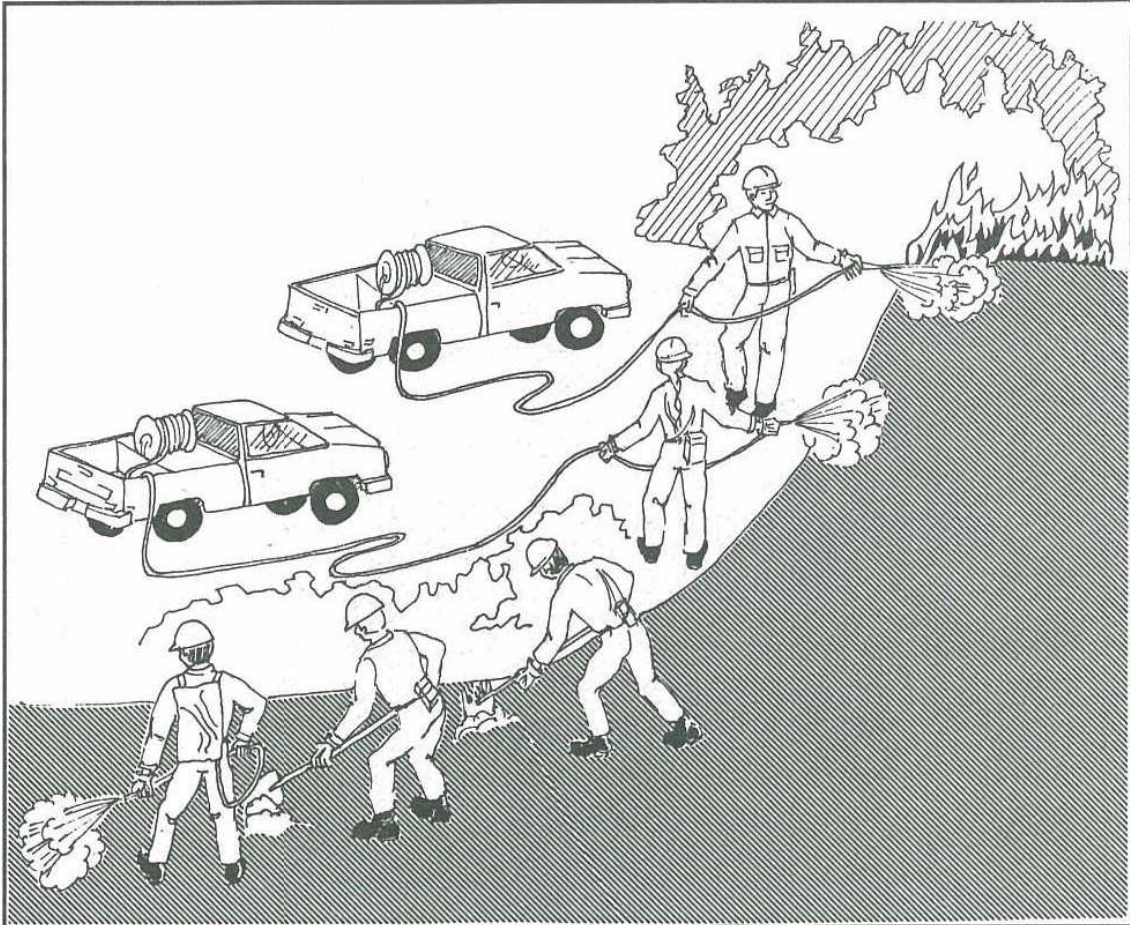

Pincer Tactic

The pincer tactic is direct attack around a fire in opposite directions by two or more engines (see Figure 14). The rear, flanks, or head of the fire can be attacked, but it is safer to anchor at the rear of the fire, flank the fire, and cut off the head.

Figure 14 – Pincer Tactic

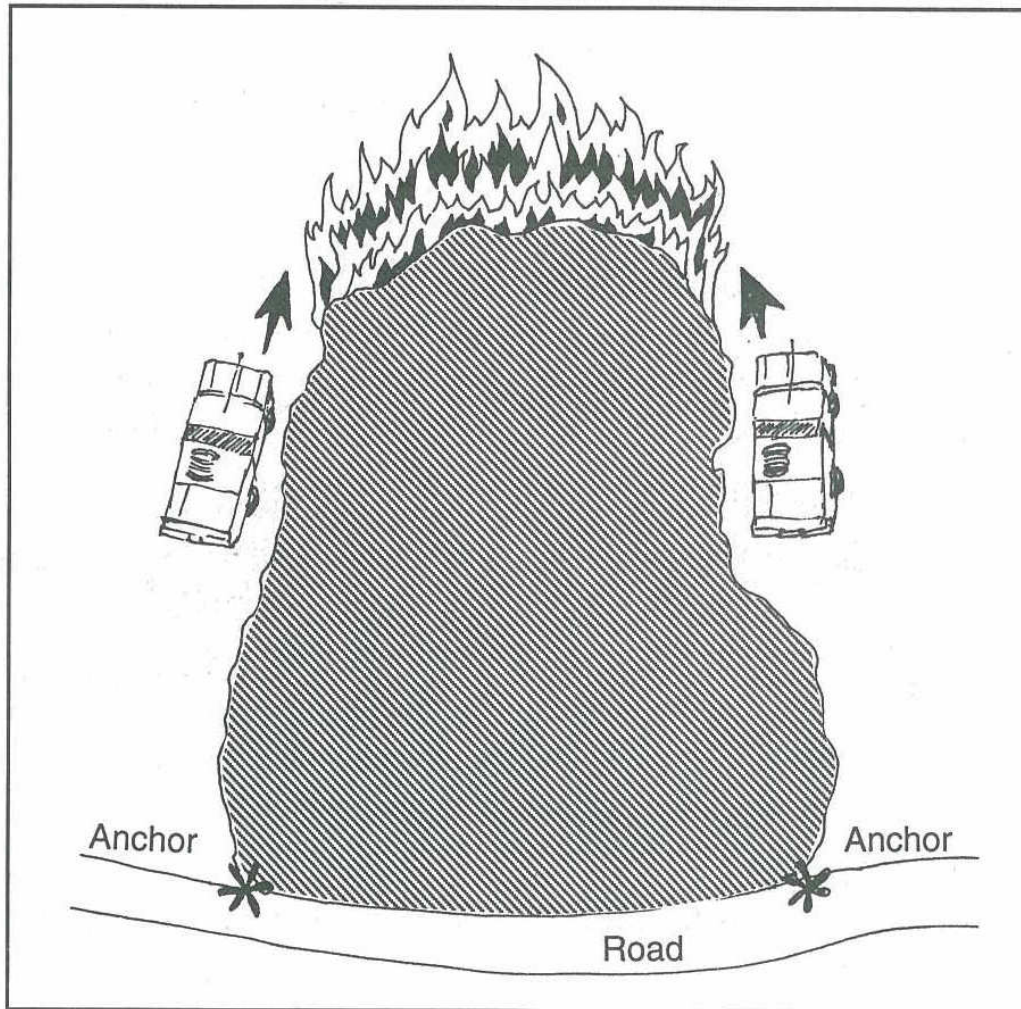

Envelopment Tactic

The envelopment tactic involves striking key or critical segments or structures around the fire area at approximately the same time. Establishing anchor points for the different points of attack is required to keep from being outflanked or overrun by the fire. Critical areas are attacked first using the hotspotting technique. The engine moves towards another engine, tying lines together. If the envelopment tactic is used, the attack must be well coordinated.

Figure 15 – Envelopment Tactic

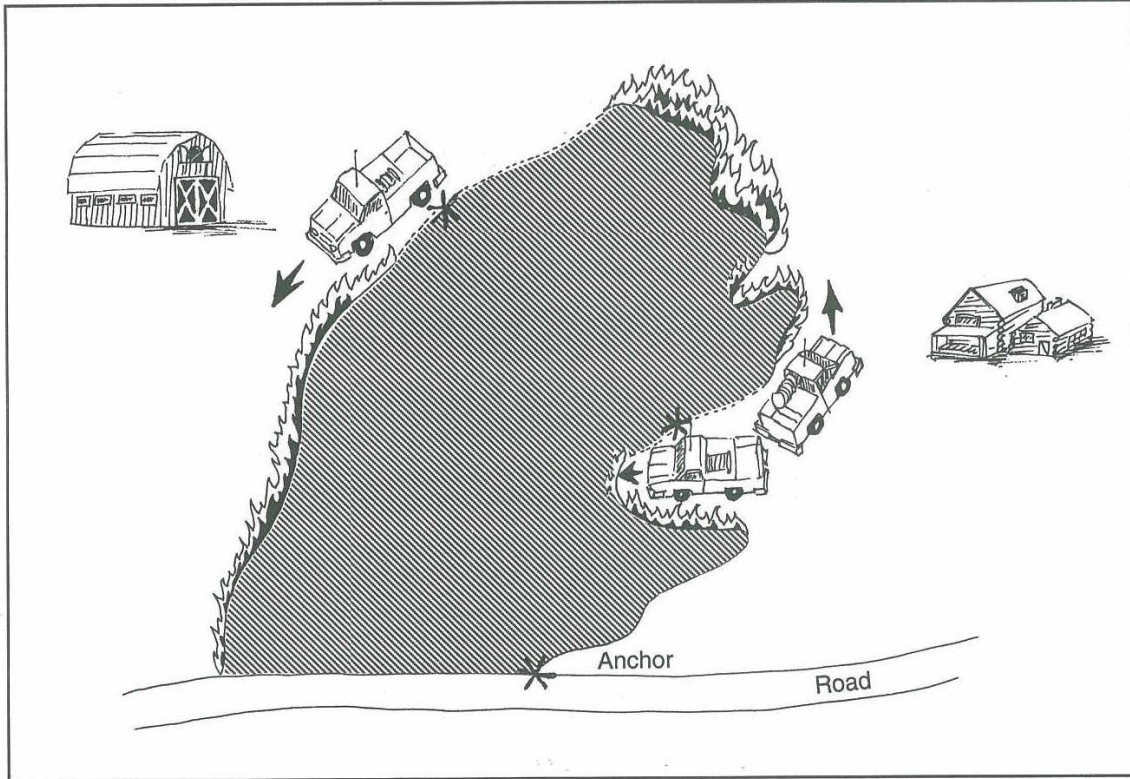

Stationary Attack

A stationary attack is the use of a simple or progressive hose lay from a parked engine (see Figure 16). Simple and progressive hose lays are covered in Section 2 - Use of Water and Additives, pages 75 to 77. A stationary attack is used primarily for inaccessible areas for engines, but where a quick hose lay will reach the fire.

Figure 16 – Stationary Attack

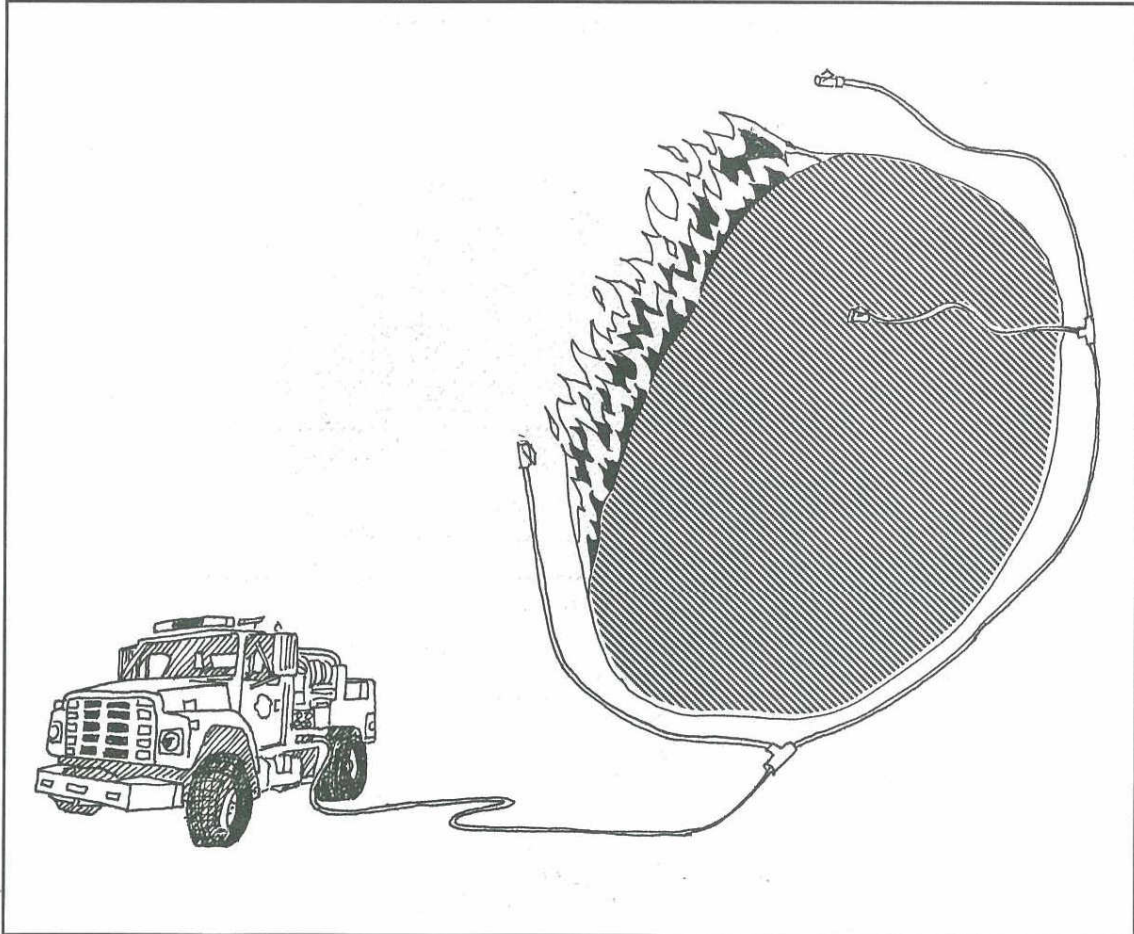

Inside-out Tactic

The inside-out tactic is a direct attack on the head or flanks of a fire from within the fire perimeter (see Figure 17). The engine can either be mobile or stationary, but should not stand in any hot materials. If the engine is stationary, wet down the area under the engine. Watch for hot rocks and fuel beds. Always have a charged line on the engine that can be used to protect the engine. In light fuel the inside-out tactic can be a safe way to attack the head of a fire because the engine and crew are already in the burned area where fuels have been consumed. An engine can use one or two nozzle operators or engines can work in tandem.

Figure 17 – Inside-Out Attack

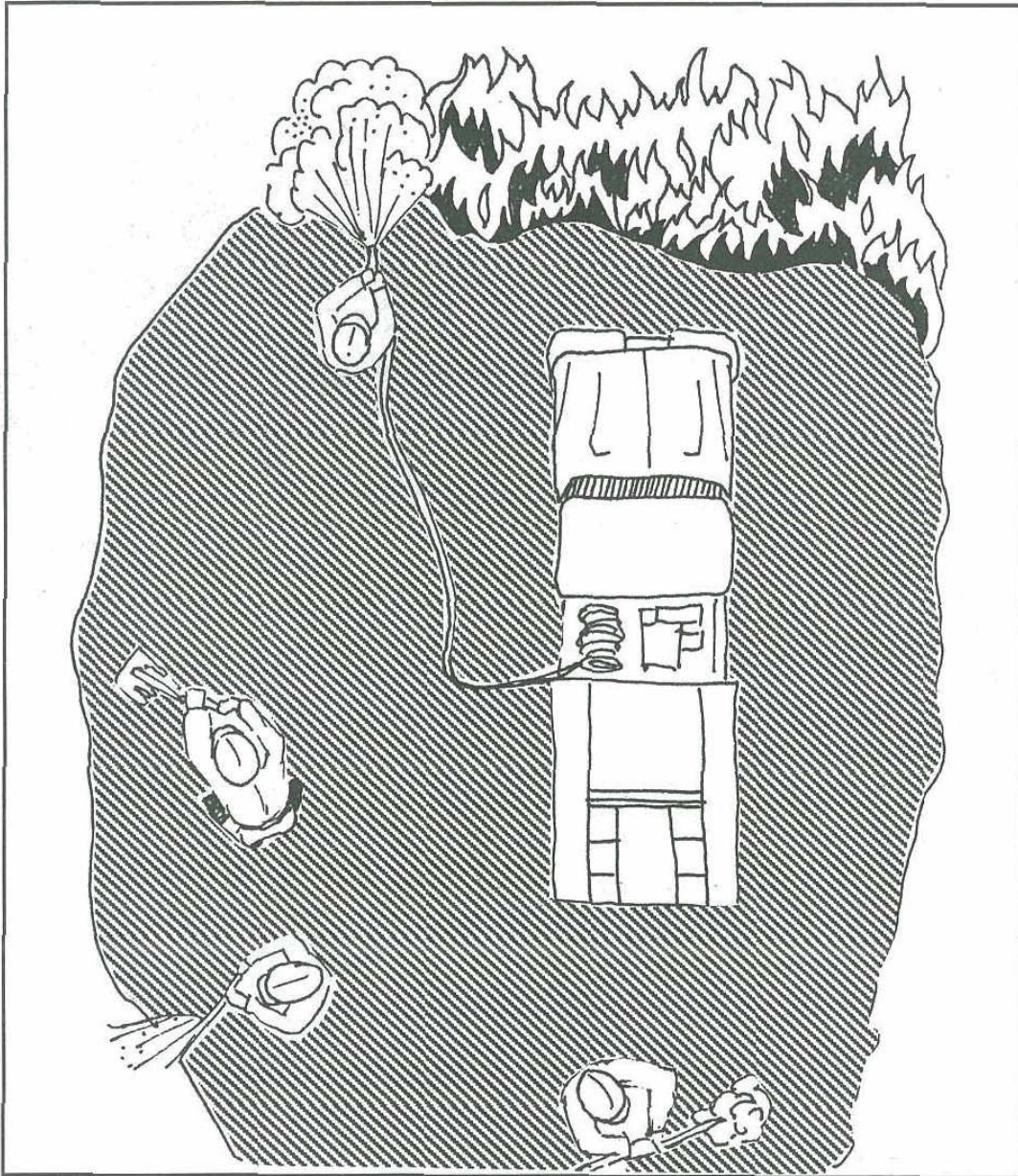

Engines can be used to make a parallel attack on fires burning in light fuel by laying down a wetline and burning out (see Figure 18). The wetline can be made from retardant, foam, or plain water.

The nozzle person uses a spray or fog nozzle to make the wetline as heavy and wide as needed to stop the fire under the current burning conditions. The wetline can be narrower if it is immediately burned out rather than allowing the fire to burn up to the wetline. Wetlines made from water must immediately be burned out.

It is always safer to anchor the wetline and flank the fire rather than attack the head of the fire.

Figure 18 – Parallel Attack With Wetline and Burn Out

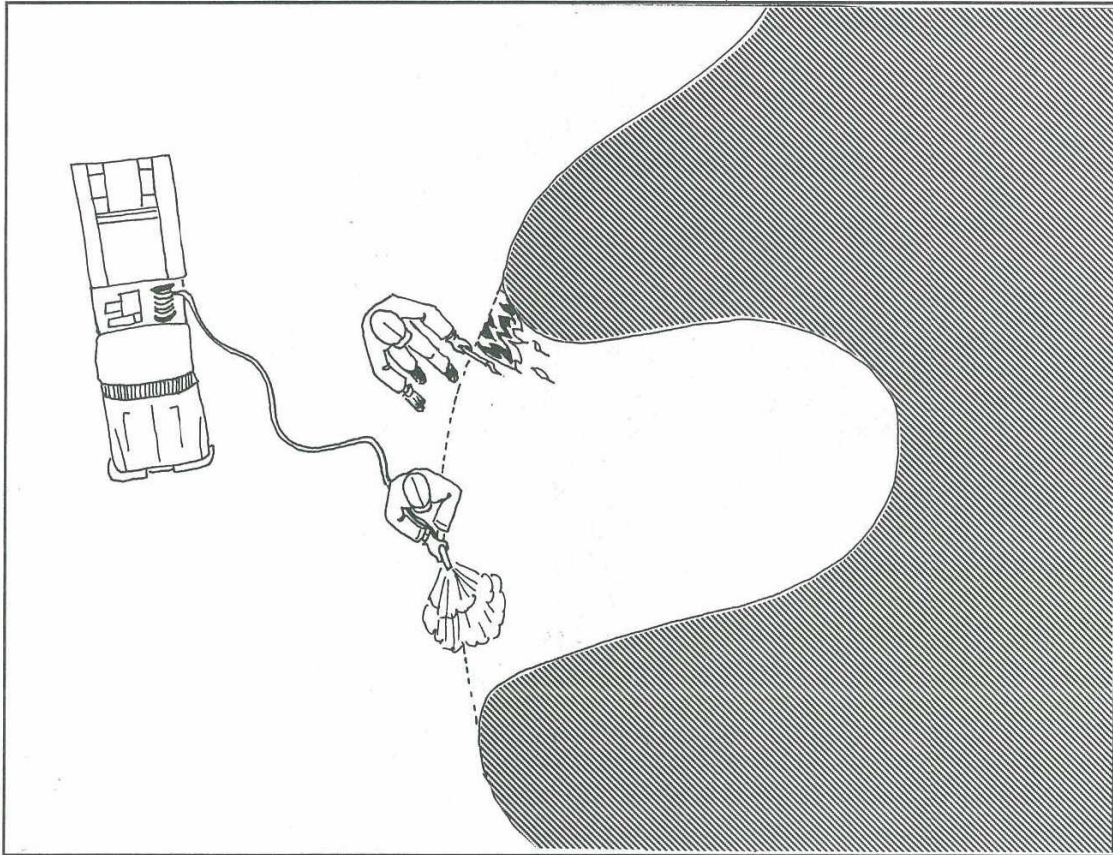

This method works well with engines in tandem. The first engine lays the wetline and burns out while the second engine reinforces the wetline and extinguishes any slopovers.

With indirect attack, engines can be used to reinforce an existing barrier such as a road or they can be used to support a dozer line or backfiring operation.

Two additional tactics that should be mentioned that could be classified as either direct or indirect attack are exposure protection and deluge.

Exposure protection is keeping the fire from high hazard fuels, high value property and equipment, and public danger areas. Water, foam, or retardant is used to cool or treat fuels or property ahead of, or adjacent to, the fire when fire fighting resources are inadequate to stop the fire spread.

Deluge is flooding or applying water in large volume to an area to completely extinguish a fire such as a fire in sawdust piles, log decks, or peat bogs. An adequate water supply is a prerequisite for using this method.

Table 4 is an overall average engine production rate for initial attack.

Table 4 – Engine Production, Initial Attack

Fire behavior	fuel model	Conditions used in	Rates in chains per crew-hour				
			Number of persons in crew				
			1	2	3	4	5+
1	Short grass	Grass	6	12	24	35	40
	Tundra		2	8	15	24	30
2	Open timber/ grass understory	All	3	7	15	21	25
3	Tall grass	All	2	5	10	14	16
4	Chaparral High pocosin	Chaparral	2	3	8	15	20
5	Brush (2 feet)	All	3	6	12	16	20
6	Dormant brush/ hardwood slash	Black spruce	3	6	10	16	20
		All others	3	6	12	16	20
7	Southern rough	All	2	5	12	16	20
8	Closed timber litter Hardwoods	Conifers	3	8	15	20	24
			10	30	40	50	60
9	Hardwood litter Hardwoods	Conifers	3	7	12	18	22
			8	25	40	50	60
10	Timber (litter and understory)	All	3	6	12	16	20
11	Light logging slash	All	3	8	12	16	20
12	Medium logging slash	All	3	5	10	16	20
13	Heavy logging slash	All	2	4	8	15	20

SECTION 5 - TACTICAL AIR OPERATIONS

The objective of tactical air operations is to aid in the effective and efficient protection of resources. In all aspects of fire suppression activities, safety must be the primary considerations when planning strategies and tactics.

Aircraft are often the most expensive single cost item on a fire. Well managed, effective aircraft use can result in reduced suppression costs.

The incident commander, operations section chief, or you, the tactical supervisor, must consider not only the cost of using aircraft, but also the cost of not using it.

FACTORS AFFECTING AIRCRAFT USE

Density Altitude

Heat, elevation and humidity make air less dense. When the density altitude exceeds 4,000 feet, performance usually begins to be affected. High density altitude reduces both the effective engine horsepower and the lift provided by the wing or rotor system, thus effectively reducing performance. To what degree this affects performance depends on the aircraft. Managers of various aircraft can determine if your objectives for tactical aircraft use can be met.

Size, Configuration, And Speed

Other factors affect the capability of the aircraft to perform a job. These include the physical dimensions and configuration of the aircraft (how it is equipped, number of seats, etc.) and its air speed. These are all factors that need to be considered when planning for tactical aircraft use.

Terrain

The lay of the land can limit the space available to orbit, turnaround, or pull-up. This certainly may limit what can be safely done.

Wind

Wind affects not only fire spread, but also air operations. Too much wind can shut down air operations. The capability to fly an aircraft in excessive wind conditions varies considerably with the weight class of the aircraft and the degree of turbulence associated with the wind.

Atmospheric Conditions

Inversions, turbulence, and position of the sun relative to the target area are some examples of atmospheric conditions that can affect air operations. Inversions can hold smoke in valley bottoms, preventing visibility of the flight path. In late afternoon, unstable conditions can create turbulence, especially along ridges and near converging drainages. The brightness makes it hard for pilots to see while turning or flying toward the sun. Brightness also makes it much more difficult to see the ground on shadowed sides of ridges.

Turnaround Times

Turnaround time is a big factor affecting aircraft use. All air operations are limited by the time it takes to return to re-load, re-fill, or get another load of people or equipment. This is especially important toward sundown when loss of daylight and pilot flight and duty limitations can adversely impact operations.

During a continuing operation, turnaround time is the lag time between time of completion of one step of a mission and the time the same aircraft is ready to perform the next step. For example, it is the duration of time in which an air tanker or helicopter departs after a drop, re-fills, and returns. Turnaround times depend on the mission, support facility locations (retardant bases, re-fueling sites, or dip sites), and the speed of the aircraft. Generally a 5 minute turnaround is considered the limit for helicopter drops; but this depends on remoteness of the location, availability of other aircraft, length of intended use, and other factors. Use of multiple helispots with re-load capability can shorten turnaround for helicopters.

Flight Hazards

Power lines, towers and cables, other aircraft operating in the area, and lack of visibility because of smoke are just a few examples of hazards. Some of these can only be seen from the ground. Make sure the pilot is informed of hazards. The only way to do this is through positive communication. You must be able to talk with the aircraft to use it safely and effectively. The presence of some hazards may preclude the desired mission, because they are too hazardous.

Aircraft Caused Fireline Hazards

Aircraft also can create hazards on the fireline. Air tankers can produce a pair of counter-rotating wake vortices about one wingspan in diameter. Normally these dissipate within two minutes. They sink at about 300 to 400 feet per minute, so they usually are weak or dissipated by the time they reach the ground if the aircraft is flying above 1,000 feet. Vortex velocity depends on the size of the wing, the aircraft speed, and the load on the wing. A vortex will feel like a wind gust which lasts from 15 to 20 seconds normally. This may be enough to initiate torching and spotting. Helicopters in level flight also can create wake vortices, but they are much weaker and are not associated with adverse fire behavior. The problems with helicopters are created by the downwash, the induced flow of air down through the rotor blades.

Environmental Considerations

Environmental considerations may affect air operations, such as restricting the use of retardants or foam, limiting landing areas and cutting of helispots in environmentally sensitive areas.

Agency Policy

Individual agencies have specific limits on pilot flight and duty hours, pilot and aircraft certification, down-loading of aircraft, and specific safety requirements. However, the current trend toward total interagency compatibility is to try and reconcile the different agency's policy within geographic areas and geographic area mobilization guides. As a fireline supervisor, these all should be a consideration for tactical aircraft use. Transportation of hazardous materials is one area that is of great significance to you as a fireline supervisor.

FACTORS TO CONSIDER IN RETARDANT AIRCRAFT USE

The following is intended to provide you with some basic and fundamental information in order to facilitate your decision to use or not use retardant aircraft. It is not intended to be comprehensive, nor does it contain technical specifications or aircraft capabilities and limitations, but does give you some common sense questions and simple guidelines. You should always consult and obtain your local agency policy on ordering or using retardant aircraft.

The best and most cost effective use of retardant is clearly initial attack. Most firefighters will also agree the best use of retardant is when there are ground forces available to follow up retardant drops.

Retardant Use Factors To Consider

1. Values at risk. The decision to use, not use, or discontinue use of retardant should be based upon the protection of, by priority ranking, life, property and resources.

Life	Firefighters and cooperators public threatened	Order immediately
Property	Homes—adjacent to public land	Highest priority
	Structures—adjacent to or on public lands	Next highest priority
	Improvements—fences, recreation sites	Priority if homes or structures not threatened
Resources	Cultural or historical sites	Use retardant to protect or prevent spread into these areas
	Watersheds	
	Range improvements	Local policy on use of retardant
	Threatened and endangered species	
	Timber stands	

2. Availability of other suppression resources. Retardant should be used in conjunction with other tactical resources. Retardant can be used to:
 - a. buy time for ground forces providing them the opportunity to complete sections of line.
 - b. tie in sections of line where line construction is difficult and slow.
 - c. cool off a section of line to allow ground forces to direct attack.
 - d. strengthen and reinforce control lines which may be too narrow to contain the fire.
 - e. pretreat fuels in advance of line building.

Remember, if you don't ask for it, you probably won't get it.

3. Fire behavior. Will the retardant be effective with the fire acting the way it is?
 - a. Crowning - difficult to get enough retardant applied to be effective.
 - b. Spotting - if spotting is widespread, fire intensity is too severe for effective use of retardant. Retardant can be very effective when used on isolated spots or slopovers.
 - c. Creeping - retardant can be very effective, but other tactical assets may be more cost effective to use if there is no threat of escape or sufficient ground forces are available.
 - d. Torching - retardant can be effective if the torching is not wide-spread. Retardant can prevent torching from becoming a crown fire.
 - e. Flame lengths –
retardant is inappropriate and not effective for direct attack when flame lengths exceed 8 feet.
4. Purpose. What will the tactical use of retardant be?
 - a. Holding - to allow time for crews to arrive.
 - b. Delay - to slow the advance so that the fire will hit barriers outside burning period, in front of highways, ridges and control lines.

- c. Control--can the fire be controlled with retardant?
 - d. Herding-direct the fire head.
 - e. Cooling-reduce intensity of the fire so crews or equipment can work.
 - f. Spot control-keep the fire within the lines.
5. Timing. Considering fire behavior, rate of spread, values threatened and other factors, will the use of retardant be effective?
- a. Can an adequate volume or amount be delivered to the fire to be effective?
 - Are flight times too long to get enough retardant to do the job?
 - Are enough aircraft available to have a continuous volume delivered?
 - b. If flight times and number of aircraft are not sufficient to be effective, then ground attack may be the only alternative unless a single load will provide protection for crews, threatened structures or improvements.
 - c. When is retardant needed? Sporadic use-continuous-morning-afternoon?
 - d. Will competition with other incidents limit retardant aircraft availability?
6. Environmental conditions.
- a. What are the winds? Retardant generally is ineffective when wind speeds exceed 20 mph.
 - b. Can the pilot see the fire? Smoke conditions may prevent the pilot from seeing the target.
 - c. Will topography allow the airtanker to make its drop and hit the target?
 - d. A guideline for airtanker drops is down-sun, downhill, and upwind. Asking pilots to do otherwise could jeopardize their safety.

TYPES, EFFECTS, AND USE OF RETARDANTS

Types Of Retardants

Retardants are generally defined as either long term or short term, which describes their overall capability.

1. Long-Term Retardant-a formulation that has the ability to reduce or inhibit combustion after the water it originally contained has evaporated.
2. Short-Term Retardant-a formulation that relies on the moisture it contains to reduce or inhibit combustion and is ineffective once the moisture has evaporated (generally in 1 to 2 hours).
3. Wetting Agent-a formulation which, when added to plain water in proper amounts, will materially reduce the surface tension of the water and increase penetration and spreading capabilities. Also called surfactant. Ineffective when moisture content has evaporated.
4. Foam-foam solution which provides for adhesion to and penetration of fuels. Foams have the same effect on fuels as short-term retardants and wetting agents. Ineffective when moisture content has evaporated.

Effects Of Retardant

Retardants and foams used by fire agencies assist the firefighter in the suppression effort by doing all or some of the following:

1. Fuel coating - the fuel is coated by the liquid and robs the fire of fuel.
2. Fuel modification - the fuel is modified by the salts or other chemicals in the retardant. This modification inhibits combustion or causes a decrease in intensity.
3. Fuel cooling - the ambient air temperature is reduced by the evaporation of the water, as well as reducing the temperature of fuel making it harder to ignite.

Use Of Retardant

Almost all retardant bases have the capability of delivering long-term retardant. Some bases have the capability of loading short-term, long-term or foam, so find out what your options are in your operating area.

1. Short-term retardant and foam can be very effective in light to moderate burning conditions with immediate ground follow-up. If ground forces are an hour or longer away-short-term and/or foam will not hold.
2. If flame lengths are greater than 4 feet-go with long-term.
3. Short-term and foam costs are considerably less than long-term. When you can use them effectively, particularly with helitankers - use them.
4. When retardants and foams are no longer effective, quit using them.
5. If flame lengths are greater than 8 feet in length-find another target on the fire or shut down the aerial application operation until conditions allow effective use.
6. Table 1 shows the recommended retardant coverage levels for various fuel types. Identify the coverage level retardant drop you want when communicating with the airtanker pilot, lead plane pilot, or air tactical group supervisor. The airtanker pilot will then determine the number of doors and sequencing, etc. to give you the requested coverage level.

Table 1 – Recommended Coverage Levels

COVERAGE LEVEL gal/100 ft ²	FIRE BEHAVIOR FUEL MODEL	DESCRIPTION
1	1	Annual & perennial western grasses; tundra
2	2 8 9	Conifer with grass Short needle closed conifer; summer hardwood Long needle conifer; fall hardwood
3	2 3 5 11	Sagebrush with grass Sawgrass Intermediate brush (green) Light slash
4	10	Short needle conifer (heavy, dead litter)
6	4 6	Southern rough Intermediate brush (cured); Alaska black spruce
Greater than 6	4 12 13	California mixed chaparral; high pocosin Medium slash Heavy slash

Table 2 describes the approximate amount of retardant line that can be expected using the various coverage levels. The aircraft type, drop speed, drop height, type of retardant (waterlike vs. thickened), and gating system all affect the length and quality of the retardant line.

Table 2 – Airtanker Production Rates in Feet/Chains Per Load*

Tanker Volume (gallons)	Feet (chains) of retardant line per load by coverage level							
	.5	1	2	3	4	6	8	10
800	924 (14.0)	631 (9.6)	305 (4.6)	155 (2.4)	95 (1.4)	28 (0.4)	0 (0)	0 (0)
1,200	1200 (18.2)	862 (13.1)	489 (7.4)	302 (4.6)	208 (3.2)	106 (1.6)	59 (0.9)	21 (0.3)
2,000	1754 (26.6)	1323 (20.0)	857 (13.0)	597 (9.0)	435 (6.6)	260 (3.9)	179 (2.7)	121 (1.8)
2,400	2031 (30.8)	1554 (23.5)	1041 (15.8)	744 (11.3)	549 (8.3)	337 (5.1)	239 (3.6)	171 (2.6)
3,000	2446 (37.1)	1990 (28.8)	1317 (20.0)	965 (14.6)	719 (10.9)	453 (6.9)	329 (5.0)	246 (3.7)

*These production rates are a generalization of information derived from research data.

RETARDANT EVALUATION CRITERIA

Evaluation of retardant effectiveness can be very complicated and subjective, however, there are some very simple and visible indicators to look for.

1. Did it stop, reduce or change the rate of spread or intensity of the fire?
2. Did it hit the target? Are you providing adequate and descriptive target identification to the pilot?
3. Did it allow you the opportunity to catch up? Did it buy you the time you needed? Did it provide you with a tactical advantage?
4. Remember that overuse of retardant is also inappropriate, if one load will do, don't order two or three. If you do have a continuing need to use retardant, consider an air tanker coordinator (most of us call them lead planes), or an air tactical group supervisor, but remember they work for you. **Don't be timid, when you feel that retardant isn't helping you achieve tactical objectives, terminate its use.**

AIR TANKER TACTICS

When applying retardant or water from the air:

1. Determine the location of the retardant line using the same criteria as you would a hand line, dozer line, or engine line.
2. Take advantage of natural barriers and light fuels where retardant is most effective.
3. Utilize breaks in topography such as ridges.
4. Always pick an anchor point to tie the retardant line into. It may be a natural barrier, a road, or a segment of line that is held.
5. Build the retardant line just as you would any other line. Avoid sharp angles.
6. Direct Attack-retardant dropped directly adjacent to or on the fire.
 - a. Initial first attack--direct attack across the head of a small fire.
 - b. Flank attack-must have an anchor point to prevent outflanking.
 - c. Spot fires-cool and corral until ground forces arrive.
7. Indirect attack is an action away from the fire's edge in anticipation of the fire's movement.
 - a. Pretreatment of fuels in preparation or support of a backfire.
 - b. Widening or strengthening of constructed control lines, natural fuel breaks, or human-made barriers to prevent escape of the fire.
8. Don't expect miracles from retardant.

Directing Drops

One of the hardest tasks for ground forces to master is directing aircraft to specific targets and locations.

1. Give general location of the fire.
2. Finalize location with:
 - a. Clock direction-Straight in front of the aircraft is 12 o'clock, and the left door is 9 o'clock. When giving direction, remember that helicopters and air attack generally orbit in a right hand pattern (clockwise) and lead planes and air tankers in a left hand pattern (counter-clockwise).
 - b. Position on slope-lower 1/3, upper 1/3, mid slope, top of ridge, etc.
 - c. Aspect-direction slope is facing.
 - d. Prominent landmarks - don't say "I have a red hard hat, I'm wearing a yellow shirt, I'm waving, I'm by the big tree," etc. Visualize what the pilot sees from the air. If on an engine, give its number if on the roof of the engine.
 - e. Use signal mirrors-stand in drop location (when safe) for identification and move away before the drop.
 - f. Use a flag - take bundles of brightly colored flagging, put them on a stick and wave back and forth to get attention of pilots. When working with helicopters in close support, you can throw the stick and flagging in the direction of the target once you have radio contact with the pilot.
3. Describe target from your location and explain mission. The pilot (lead plane or air tanker) will decide drop technique and flight path.
4. Be sure you know aircraft intentions before the drop. Inform and assure pilot when all personnel are out of the drop area. Supervisors have responsibility for the safety of all resources assigned to them.
5. Give feedback to the pilot about drop accuracy and quality. Be honest and constructive. Let pilot know if drop was early, late, uphill, downhill, on target, etc. Report low drops immediately.

Safety

Make sure that you adhere to the principles of safety whenever you are involved with ground forces and retardant dropping operations.

1. Clear the area of the drop-move back in as soon as the aircraft has left the area-take advantage of the retardant.
2. Caution your ground forces to watch their footing when working in the area where the drop has been made, as wet retardant is slick.
3. If the retardant has been dropped across a highway, slow down the traffic or wash it off, it makes cars slip and slide too.
4. If working in timbered areas, be alert for snags, tree tops or the possibility of other falling debris knocked loose by retardant.
5. Be cautious of low drop heights by aircraft. The resulting retardant drop will pick up and move rocks, dirt, brush, logs, fire tools, engines, etc. The smaller airborne materials will travel at the drop speed of the retardant.

PRINCIPLES OF RETARDANT APPLICATION

1. Determine tactics, direct or indirect, based on fire sizeup and resources available.
2. Establish an anchor point and work from it.
3. Use the proper drop height, which is approximately 150 to 200 feet. However, many factors such as topography, type of airtanker and gating system, wind direction and speed, type and height of fuel, etc. affect drop height.
4. Apply proper coverage levels.
5. Drop downhill and down-sun when feasible.
6. Drop into the wind for best accuracy.
7. Maintain honest evaluation and effective communication between you and the aircraft.
8. Use direct attack only when ground support is available or extinguishment is feasible.
9. Plan drops so that they can be extended or intersected effectively.
10. Monitor retardant effectiveness and adjust its use accordingly.

SECTION 6 - WILDLAND/URBAN INTERFACE

The purpose of this section is to provide wildland firefighting agencies some tactics and techniques to protect structures from wildland fires. **This section is not intended to train structural firefighters nor preclude agency policy dealing with fires in the wildland/urban interface.**

KINDS OF WILDLAND/URBAN INTERFACE

Where people, structures and wildlands meet is called the wildland/urban interface. This interface has received attention because of the many disastrous wildfires in these interface areas (e.g., Dude Fire, Glen Allen, Oakland Fire, Black Tiger, Mound House, etc.).

There are three types of wildland/urban interface.

A *mixed interface* occurs when structures are scattered over a large wildland area. Isolated cabins surrounded by large blocks of industrial or public wildland would be a good example of a mixed interface. Large wildland fires in this type of interface may endanger only very few structures.

Occluded interfaces are defined as isolated areas of wildland within an urban area. New York's Central Park and Los Angeles' Griffith Park come to mind as examples of occluded interfaces. Many structures are at risk, but the potential for severe wildland fire behavior is low due to small total wildland area.

A *classic interface* is found when many structures, often on small lots, border wildlands on a broad front. The inter-mix of vegetation and structures can put many structures at risk in what would otherwise be an average wildland fire in terms of behavior and damage to the wildland resource. This classic interface area represents the greatest potential for loss of life.

STRUCTURAL FIRE BEHAVIOR

Structural fire behavior differs from wildland fire behavior in many ways. Fuel loadings may be a factor of 300 or more times greater than wildland fuel loadings. Fuel moistures of structural fuels are greatly influenced by indoor relative humidity, and timelag of treated woods may be much longer than one would expect when used to dealing with only size-related timelags. Radiant and convective heat in the interior of a structure is retained and not lost to the atmosphere. Oxygen supply available in structure interiors has a major impact on structural fire behavior. Structure fires may be oxygen-limited as opposed to wildland fires which usually are fuel limited.

Fuel types in structural fires are not limited to naturally occurring materials. Synthetic fuels present a wider range of fire behavior and can produce highly toxic combustion materials, in addition to the ever present danger posed by carbon monoxide.

There are also risks associated with structural fires that are not usually present in wildland fires such as structural collapse, flashover, electricity, hazardous materials, etc.

WILDLAND/URBAN FIRE SIZEUP CONSIDERATIONS

Wildland/urban fire sizeup considerations differ somewhat from wildland fire. The paramount consideration, however, is the same in both, *rescue/life safety*. This consideration applies to firefighters as well as to structure occupants. *Operations necessary to protect life, such as search and rescue in a burning structure, should only be undertaken by trained and experienced firefighters equipped with full turnout gear and self-contained breathing apparatus.* Smoke and toxic gases are the greatest hazards in structural firefighting.

The following are considerations for a wildland/urban fire sizeup:

A. Structures and improvements.

1. Number, arrangement, and kinds of exposures.

Look at the placement of improvements and anticipate fire behavior.

2. Note clearance around structure(s) (defensible space),
3. Size, height, and occupancy type.
4. Construction features: roof coverings, wood shake or shingle roofs (probably the greatest single hazard), wood siding, decks, eaves (exposed vs. covered), attic vents, rain gutters (empty or full of debris).
5. Safety and rescue.

Evacuation could involve both people and animals. Note safe refuge areas (outside and inside or behind structures). Consider other hazards, some hidden (septic tanks - which can collapse when subjected to heavy weight, insecticide storage), and some obvious (power lines, liquefied petroleum gas [LPG] and fuel tanks).

6. Water supplies. Note location, availability, and reliability.
7. Combustibles located near structures (wood piles, vehicles, vegetation, etc.). Can they be removed?

B. Access. Note ingress and egress and one-way or narrow roads. Can firefighting equipment get into the area to protect structures? Consider the width of bridges and their load limits.

C. Fuel

1. Type of fuel (grass, brush, timber, ornamentals). Note the size and arrangement and continuity of fuels, and their proximity to structures and improvements.
2. Age of fuel. Observe the amount of dead material in fuel.
3. Consider structure fuels. These can be high volume fuel that produces large amounts of radiated and convective heat. Wood shake and shingle fires are difficult to extinguish and may cause spot fires.

D. Weather. Observe site specific weather.

1. Wind - note windspeed and direction (probably the key element of wildland fire behavior). Local winds may be quite different from general winds. They will be influenced by topography, fuels, structures, and in major fire incidents, by the fire itself.
2. Temperature-affects fire behavior as it affects your fuels (solar heating and drying).
3. Humidity-dryer air is better able to pick up moisture from the fuel. The result is that less time is required for heat buildup and combustion.
4. Stable vs. unstable atmosphere-are you experiencing major wind shifts and firewhirls? Both are indicators of unstable weather conditions.

E. Topography. Observe the following and anticipate their effects on fire behavior.

1. Canyons-wide vs. narrow, box, or chute.
2. Ridges-saddles and chimneys.
3. Slope-steep vs. flat terrain.
4. Physical barriers-both natural and artificial; roads, rivers, green belts, fuel breaks, cliffs, or large bodies of water.

F. Fire behavior - observe local fire behavior.

1. Fire location, speed, and direction. The basic determination of how far away it is and how fast it is moving. This will give you approximately how much time you have before structures may be involved.
2. Firewhirls.
3. Spotting--can you anticipate spot fires prior to the fire front reaching you? This could affect your attack plan and the safety of firefighters.

G. Resources

Are there enough resources on hand or do you have time to order and receive additional resources? Consider the following:

1. Other entity and/or agency involvement such as law enforcement for road closures and evacuation. Structural fire departments.
2. A last minute fuel clearance effort. Evaluate the terrain. Is it suitable for dozers, engines, or hand crews? Structural protection and workforce. Consider firing out around structures. Do you have the necessary resources?
3. Structural protection and workforce. Consider firing out around structures. Do you have the necessary resources?
4. Air support (fixed wing and helicopters). They both have limitations.
5. Terrain for access. It may be suited only for smaller, more versatile equipment.
6. Water needs and sources. Water tenders may be needed.
7. Need and availability of special equipment.

STRUCTURE TRIAGE

Structure triage is the sorting and prioritizing of structures requiring protection from wildland fire.

Triage can be required of anyone at any time on a wildland/urban fire incident; from the incident commander doing reconnaissance to an engine crew moving into position.

The goal of triage is to do the most good with what you have and to not waste limited resources or time. It requires categorization of threatened structures as:

- Needing little or no attention for now.
- Needing protection, but savable.
- Indefensible.

There are no absolute answers, but five factors to help make a triage decision are:

- Firefighter safety
- The structure itself
- Surrounding fuels
- Fire behavior
- Available resources

Consider the following:

A. Firefighter safety

1. Ingress/egress routes
 - One way/two way
 - Slope and steepness of road
 - Bridges
2. Power lines
3. Smoke/visibility
4. Hazardous materials
5. LPG and overhead fuel storage

B. Structure construction features, condition, and exposure.

1. Roof

- Combustible-wood shakes, tar paper, etc.
- Non combustible-tile, metal, or fiberglass, etc.
- Pitch-debris on roof or in gutters

2. Siding

- Combustible-wood.
- Non combustible - metal, brick, etc.

3. Heat traps

- Open gable
- Vents without screens or non fire resistant screens
- Overhanging decks

4. Windows

5. Size of building

6. Shape of building

7. Position on slope

C. Surrounding fuels

1. Size and arrangement

2. Age

3. Proximity to structure

4. Loading

5. Types

- Resistant or flammable
- Landscape/ornamental
- Grass, brush, timber, exotic (palmetto, etc.)
- Wood piles

6. Landscaping-railroad ties, wood fences
7. Defensible space, access
8. Yard accumulation
9. Flame or heat duration
10. Explosive-liquified petroleum gas (LPG) tanks, diesel or gas storage tanks

D. Fire Behavior

1. Rate of spread and direction
2. Topographic influence
3. Weather influence
1. Flame length
5. Spotting
6. Natural or other barriers

E. Available resources

1. Kind and type equipment available
 - On site resources (water, equipment, ladders)
 - Location
 - When available-response time
2. Capabilities and limitations
 - Mobility
 - Water/foam
 - Retardant

WILDLAND/URBAN INTERFACE FIREFIGHTING TACTICS

This section is intended to provide some basic tactics to deal with wildland fire in the wildland/urban interface within the policy of your agency. If your agency policy does not include structure firefighting, the information in this section is not suggesting that you enter burning structures or fight structure fires.

Generally, the moving fire controls the action. Mobility, wise water use, and methods effective in wildland fire control are commonly required. Resources defending structures must be mobile, resourceful, and self-reliant.

Implementing tactics of structural firefighting should generally consider structure triage. That is, concentrate on doing the most good with what you have and to not waste limited resources or time. Concentrate on the savable structures rather than the hopeless.

Initial Actions

Turn the traffic control over to law enforcement. To gain access to threatened structures will require sorting out the traffic problem. Clear existing traffic to *0* make way for fire equipment, and keep it moving.

Come up with a traffic plan. Identify routes into and out of the area. Where roads are too narrow to allow two way traffic you may need to set up a one-way loop. When possible, post signs or individuals to indicate the routes and directions. Note weight limits or bottlenecks that may limit some equipment.

Evacuation may be desirable to clear the area for firefighting operations and minimize risk to citizens. Civilians can be asked to leave, but only law enforcement has the authority to make them leave. Little is to be gained by arguing with someone who will not leave.

Prior to evacuation, and if time exists, homeowners and firefighters can make some structure preparations to minimize a structure's receptiveness to ignition and fire spread. Assistance in the preparations can come from other sources such as engine crews, hand crews, and heavy equipment.

1. The roof is the most readily and frequently ignited part of a structure exposed to wildland fire. Remove any easily ignited material that is lying on the roof. Clear needles and leaves off of the roof and out of the rain gutters.

2. Remove or separate intermediate fuels that pose a threat to the structure. Move woodpiles away from buildings. Remove combustible vegetation near the structure. Remove flammable awnings and other combustible materials that attach to buildings.
3. Cover openings and potential openings. Any entry of fire or firebrands into the structure greatly increases control problems and the likelihood the structure will be damaged or destroyed. Concentrate your efforts on those openings on the side of the structure that are most exposed.
 - Vents and ducts, even though covered with screen, need to be covered. Use whatever can be nailed or propped over the hole that is not easily ignited.
 - Windows should be closed with screens attached. Even if windows are intact it is worth covering them to keep them from being broken by heat or hose streams. Use plywood, sheet metal, or flat panels.
 - Large openings such as doorways or breezeways are hard to cover. Sheets of plywood, or even tarps and salvage covers can be used.
 - Evaporative coolers can be ignited by firebrands getting into the pads. If they cannot be covered, turn on the water pump and turn off the blower.
4. Interior structure preparation.
 - Remove light curtains and easily ignited materials from the vicinity of windows. Drapes made of readily flammable material should be drawn back or taken down.
 - Close non-flammable window coverings such as blinds, or shades and drapes.
 - Turn off fans, coolers (except water coolers), or anything that blows air.
 - Turn off gas (LPG or natural) at the source.
 - Leave electricity on to run pumps, provide lighting, etc.

- Leave a porch light and a central interior light on to provide visibility in dark and/or smoky conditions.
 - Do not lock doors and make sure doors can be opened.
5. If the homeowner has a ladder, place it in position to provide access to the roof. Place the ladder in a visible location so anyone needing access to the roof can see it.
 6. Connect available garden hoses and test for water pressure.
 7. Vehicles that will remain on site should be parked in the garage or away from flammable material near or underneath the vehicle. Park vehicles headed out with the keys in the ignition. Close the doors and windows, but do not lock the vehicle. Make sure vehicles will not interfere with the movement of fire equipment or block the driveway.
 8. Pets and livestock that are free to move around generally will manage to avoid being burned. If they are fenced or chained, they may need to be freed. Troublesome or frightened pets might need to be placed in the garage, residence, or other enclosure.

Confronting The Fire At The Structure

Deciding how to handle the fire itself is challenging. It requires considering the fire environment, the structure, and the situation of adjacent crews. Consider the following four general situations, and decide which one applies. It is quite possible that the situation may change in the course of the fire.

1. Spotting zone.

You are in the spotting zone, where firebrands are the major problem. The main fire may move through later (putting you in a different situation), or it may never get there.

Airborne firebrands are the biggest problem, and the threat may exist for several hours. Firebrands may ignite new fires a mile or more ahead of the main fire.

Remain mobile enough to quickly reach any point within your area of responsibility. It may not be necessary, or desirable, to deploy lines except to actually put out a fire. When deploying line you should not deploy more than 250 feet of hose.

Constantly check for new ignitions; this is not a time to relax your vigilance. Watch prime receptive fuels such as roofs and woodpiles. Patrol as necessary, and post lookouts with communications. If a spot fire occurs, attack it quickly. Make sure it is completely out, or at least has a good enough control line that it cannot spread. When deploying lines you should not deploy more than 250 feet of hose.

2. Full containment around the structure.

Full containment of the wildland fire before it gets to the structure(s) is possible. You can stop the wildland fire short of the structure itself (see Figure 1). Your control line will completely surround the structure or will join adjacent control lines.

Figure 1 – Full Containment

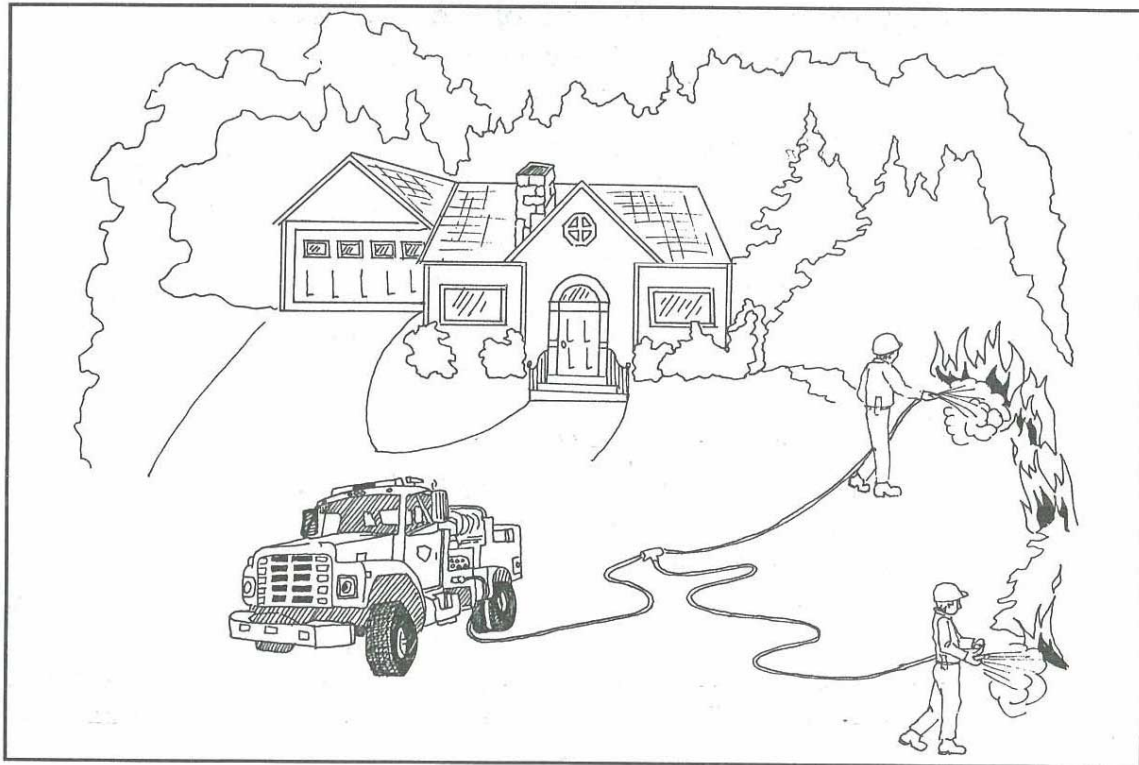

Cut off the fire before it reaches the buildings, essentially at the outer edge of the yard or where wildland fuels begin.

If you have time to wait for the fire and it's not too intense simply put it out when it reaches the control perimeter. Use water, handtools, or let it burn into a fuel break. Such fires might be burning in light fuels and not be driven by wind or slope. If you cannot wait for the main fire, or if the fire will be too intense for direct control, you can fire out from a control line.

3. Partial containment around the structure.

Only partial containment is possible. You may be able to modify or diminish the fire as it hits, but the fire will move past the structure before you can establish control (see Figure 2).

Figure 2 – Partial Containment



If there is not enough time or the fire intensity will not allow you to establish complete containment, you can still attempt to reduce the fire's intensity as it moves towards the structure.

Use your working lines to knock down the segment of the fire that is moving directly toward the structure. It may also be possible to light a backfire from a short section of control line to take out the most threatening segment of fire front.

When you have split the fire front, use your working lines to lead the fire on around the structure. Essentially, peel the fire back and around the building.

After the main fire passes, put out any fire remaining on the fringes. Quickly check the structure for fire. Remember the common ignition points, and check thoroughly.

4. No containment around the structure.

No containment is possible. The wildland fire will blow through essentially unchecked. Your effort will have to be directed to the structure (see Figure 3).

Page 3 Figure 3 – No Containment

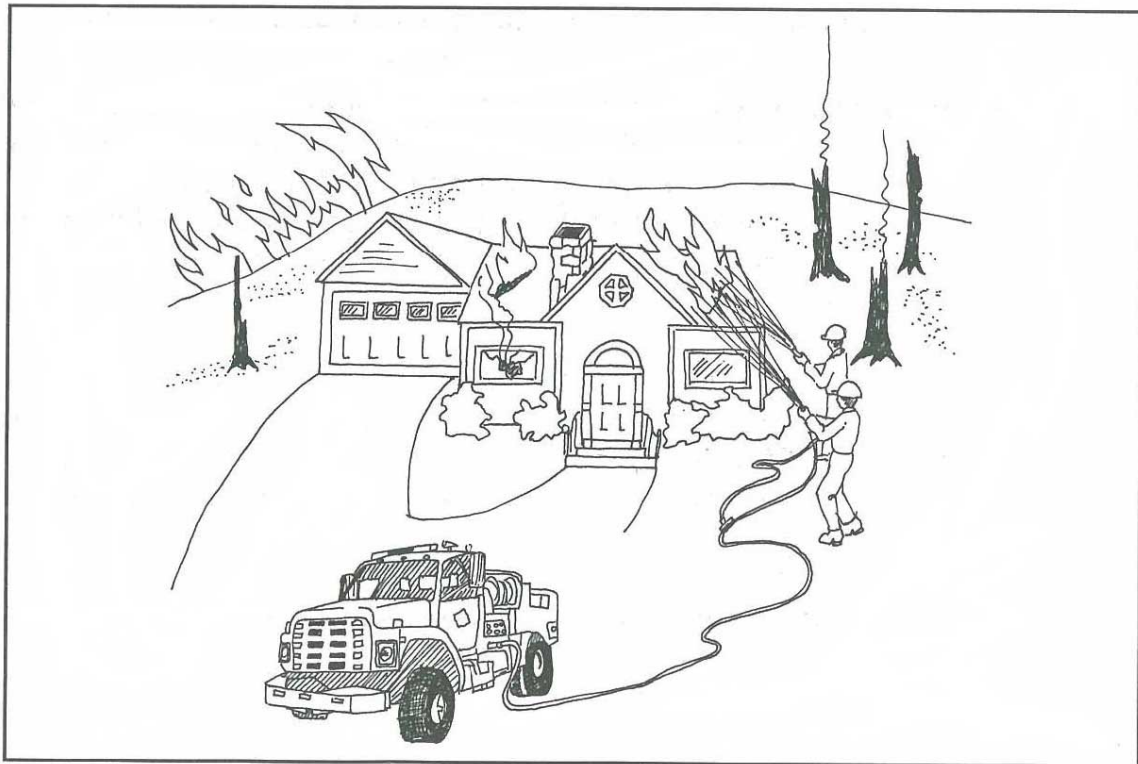

Direct all hose lines onto the structure and allow the wildland fire to bum past. If your position becomes undefendable or the fire intensity threatens your safety, then retreat to your pre-established safety zone and re-enter the area when the fire has passed. Again, remember the common ignition points, and check thoroughly. If the structure is on fire direct your effort to putting out the fire.

Flammable roofs are frequently ignited by wildland fires. When the fire on the roof is small, the key is to attack the fire immediately. It can be extinguished from the outside at this stage. Make sure the fire is out and remove the involved shingles to make certain.

When the fire has spread across the roof, the structure is seriously threatened, especially in high wind. The following outlines a technique that has saved some well involved structures with fire.

- An exterior line should be directed at the roof fire from close range. Working from the upwind side place the water stream at an angle to get water under the shingles. If the fire is on the downwind side of the roof, knock it down the best you can and then get some water directed up at the edges of the shingles.
- Simultaneously take a line into the interior to attack the fire in the attic or inner spaces of the roof if there is no attic. You want to intercept and stop the fire as it advances. Estimate where you think the leading edge of the fire is. Pull down the ceiling at that point and forget looking for the crawl hole, it usually takes too much time.
- Get a stream of water on the advancing fire edge as quickly as you can. Since fire is usually running up the roof slope, you will be directing the stream so that it gets somewhat in between the shingles. Use water only as needed. Indiscriminate use will cause excessive damage.
- Firefighters on the interior line should be wearing full protective turnout clothing and breathing apparatus.

Water Application

Wise water use is critical to the success of structure defense efforts! Effective application is the key to conserving water.

The timing of water application with respect to the passage of the heat wave is important. Wetting down structures and roofs before the fire arrives is usually a waste of time and water. In the face of winds, low humidity, and fire, the wetted surfaces will soon dry out and be susceptible to ignition. However, application of foam to structures prior to fire passage has demonstrated favorable results.

Use water to knock down the fire in surface fuels and prevent fire from spreading to structures if at all possible.

During the peak of the heat and smoke, it is tempting to squirt water at the wall of flame, hoping that it will somehow improve things. But, it will probably do little good and will waste water.

To escape the intense radiant heat, seek refuge behind something that blocks it. Duck behind a wall or stay below the roof peak on the sheltered side. Then step out and put water where it counts.

Remember to save enough water for self protection.

Summary Of Wildland/Urban Firefighting Concerns

What is your agency's policy on fighting fires in the wildland/urban interface and fighting structure fires? You must operate within your agency's policy and guidelines.

Look at all the factors that may influence your selected method of attack. A major difference from the usual structural tactics is that the fire source will be external to the building and not within. The structural fire is going to start on the outside of the building.

What kind of access is available? Is the road or driveway accessible with your equipment? Is the road blocked by a locked gate? Is there space to park one or more units? Can the trucks be turned or must you back all the way in? Are the homes on a cul-de-sac?

Take a good look at the forest fuels adjacent to the building you are to protect. Consider the species, the spacing or density; are there slash piles or other flashy fuels likely to become involved? Is there any clearing around the building?

Is there a water source near the building? Must water be delivered by a water tender? How far is it to the nearest water opportunity? Can you set up a portable pump?

Look out for open garage doors that allow firebrands to start an interior fire. Wood piles near the building will require a lot of water to control if ignited.

Heating oil storage tanks or bottled gas will present another hazard that must be considered.

Be alert for electric power lines. Downed poles or sagging lines are often encountered in the wildland fire.

How is the wildland fire spreading? In what direction and how fast? How will the wind and other weather factors affect the fire's advance? Are there any existing fire breaks or other topographic features that will influence the fire? How intense is this fire? Is it a crown fire? Are there any slash piles that may cause spotting or hot spots?

What is your position relative to the fire and its spread?

Dense smoke may hamper your movements and may disrupt your radio communications. How many buildings are endangered? Do you have enough equipment and personnel?

Assess the risk--consider all the factors: access, fire prone property elements, water source, hazards, fire behavior, forest fuels, weather, and number of buildings.

You must know the capabilities of your firefighters. Have they been trained in structural fire operations? Are relationships with other agencies clear and understood by all those involved? Are command and communication channels established?

Review the structural watch out situations on the next two pages.

THE STRUCTIURAL SITUATATIONS THAT SHOUT “WATCH OUT”

Presented by
Don Johnston
Rural Metro Corp, Phoenix, Arizona
to
Region Three Engine Operators Workshop
April 9, 1991

1. Structures are wooden construction with shake shingle roofs.
2. Access is poor, i.e., roads are twisting with sharp curves, narrow single lane roads, dead end roads, inadequate turning radius at road ends, etc.
3. You have inadequate water supplies to attack the fire.
4. Natural fuels are within 30 feet of the structures.
5. There are strong winds and erratic fire behavior is occurring.
6. Structures are located in a "chimney" or canyon situations.
7. There are panic-stricken publics in the vicinity (known or suspected).
8. Structures have open crawl spaces and contain added fuels under the structure.
9. Bridges in the vicinity are narrow and/or have light or unknown load limits.
10. There are propane tanks or elevated fuel tanks present (most rural situations have).
11. There are septic tanks and leach lines (most rural situations have).
12. There are garages with closed, locked doors.
13. The structure is burning with puffing vs. steady smoke emissions.
14. Windows of the structure are black or smoked over.
15. Windows of the structure are bulging.

**CREATIVITY AND INNOVATIVE THINKING AT ITS BEST:
An adaptation of the structural firefighting watch out situations and
the related six components of structural triage as re-evaluated and
made easier to remember**

by
Jay W. Tischendorf
Hotshot Crewmember
Payson Hotshots

Structural "Watch Out Situations" can be remembered by the words - ALWAYS THINK SAFE - which stand for:

- A - Access is poor (i.e., roads are narrow, twisting, single lane tracks with inadequate turning radii).
- L - Load limits of local bridges are light or unknown, and the bridges themselves are of narrow proportions.
- W - Winds are strong and erratic fire behavior is occurring.
- A - Area contains garages with closed, locked doors.
- Y - You have an inadequate water supply to attack the fire.
- S - Structure windows are black or smoked over.

- T - There are septic tanks and leach lines. (These are found in most rural situations).
- H - House or structure is burning with puffing rather than steady smoke.
- I - Inside and/or outside construction of structures is wood and they are topped with shake shingle roofs.
- N - Natural fuels occur within 30 feet of the structures.
- K - Known or suspected panicked publics are in the vicinity.

- S - Structure windows are bulging and the roof has not been vented.
- A - Additional fuels can be found in open crawl spaces beneath the structures.
- F - Firefighting is taking place in or near chimney or canyon situations.
- E - Elevated fuel or propane tanks are present.

SECTION 7 - FUELS, FIRE BEHAVIOR, AND TACTICS BY GEOGRAPHIC AREAS OF THE UNITED STATES

The purpose of this section is to identify by geographic areas of the United States:

- important fuel, topographic, and fire weather conditions that produce critical fire behavior situations.
- appropriate safety, strategies, and tactics for fire suppression.

The following geographic areas are covered:

- Alaska, pages 205 - 218
- Northwest and Northern Rocky Mountains, pages 219 - 236
- Southern and Central California, pages 237 - 256
- Great Basin and Southern Rocky Mountains, pages 257 - 282
- Southwest, pages 283 - 296
- Northeast, pages 297 - 312
- Southeast, pages 313 - 332

ALASKA

I. FIRE BEHAVIOR ENVIRONMENT

A. Fuels.

Boreal forest fuel types present suppression and management situations very different from those found anywhere in the lower 48 states.

You must be familiar with these differences to accurately assess the situations. In addition to the fuel type/fire behavior differences, there are logistical problems which necessitate longer time lines. Therefore, a knowledge of fuels, suppression options, and logistical considerations is required prior to mobilization.

The fuel you need to be aware of can be grouped into four types: Tussock tundra, black spruce, hardwoods, and white spruce. Ninety percent of the problem fires in Alaska occur in the tussock tundra or black spruce type. The Hardwood type is usually not a problem and will be discussed as a target of opportunity in making your decisions. White spruce is generally only a problem during extended drought.

1. Tussock Tundra

a. Description.

Tussock tundra can best be described as a bunchgrass prairie in which all of the space between the bunches have been filled in with a thick cushion of other plants. Tussock tundra is found on extensive areas of gently rolling land in western Alaska, and on shallow slopes on many mountain valleys in the interior. Permafrost (permanently frozen ground) occurs beneath, and a thick organic layer is present unless the tundra has been severely burned fairly recently.

b. Fire Behavior in Tussock tundra

Tussock tundra can be a dangerous fuel because of its flashy nature. Fifty-five percent is approximately the relative humidity (RH) at which "moisture of extinction" occurs. A 30 percent relative humidity with a moderate wind leads to a three foot flame length.

This is, of course, approaching the limit of successful handtool work without the aid of water or retardant. With 15 percent relative humidity and wind speeds of 15 mph, 10 foot flame lengths can result. Obviously, this condition is too hot to handle with conventional handtools. For the fire behavior analyst, the fire behavior fuel models fit very nicely and do not present the variable problems that some fuels do.

Tussock tundra is similar to Grassland Models 1 and 3 depending upon the height. If tussocks are less than one foot, use Fuel Model #1 (short grass). If they are more than 1 foot, use Fuel Model #3 (tall grass). The terrain simplicity of tussock tundra is a major advantage in suppression considerations. Tussock tundra is usually found on flat ground or on the lower 113 of gentle slopes.

The depth of tundra burning is dependent upon the dryness of the fuel and the organic layer beneath.

Great variation in depth of burn is to be expected depending on the time of year or drought condition, and relative humidity/wind conditions at the time of burn. Normally, once active flame is removed in tussock tundra, it does not present a mopup problem. Cold trail of the line 24 hours after the flame is extinguished usually suffices to assure the perimeter is secure.

2. Black Spruce - Feather Moss.

a. Description.

Black spruce stands are widespread on moist, poorly drained sites and typically underlain with permafrost. Generally, they are in relatively flat valley bottoms, or flat to gentle rolling land, and on cold slopes having a northern exposure. These trees are small. Maximum heights in mature stands seldom exceed 30 feet, but can grow to 50-60 feet in height. They are slow growing and seldom exceed 8 inches in diameter and usually are much smaller. A tree 2 inches in diameter is over 70 years old. Characteristically, mature trees "bunch out" at the top.

This effect is taken advantage of by firefighters as it's common practice to use a black spruce top (spruce bough) to beat out the fire. Spruce often occurs in clusters and/or clumps of trees or can form a continuous, solid stand uninterrupted for miles.

Fires are intense in black spruce, usually killing all trees and consuming all needles during crown fires. Black spruce has adapted to fire primarily through its abundant seed production in semi-serotinous cones. Approximately 75 percent of Alaska's problem wildfires occur in the Black Spruce - Feather Moss types. It is in this fuel type that fire conditions and suppression situations are very different from those of the lower 48 states.

b. Fire Behavior in Black Spruce/Feather Moss.

Fires in Alaska black spruce are most often crown fires, yet they are rarely running independent crown fires. That is, the fire is carried by surface fuels, with a crown fire often following some distance behind the fire front, giving the impression of a full-blown running independent, crown fire. The tendency of fires to crown is related to the distribution of the fuels within the stand, the flashy carrier fuel, and the dry black spruce needles. In most black spruce stands, the carrier fuels can carry flames three feet above the surface. The black spruce branches (often with dead lichen covering the lower branches) will ignite from the carrier fuel and carry flames directly into the crown. The layering of the lower branches provides nearly continuous fuel from the forest floor to the tree crowns (ladder effect). The Cladonia, or caribou moss, is an excellent indication of fuel moisture as it crumbles when dry and is resilient when the RH and fuel moisture is increased. A significant change can be observed in a 20 minute period of drying.

The key to black spruce crowning is the carrier fuel and the low moisture content of black spruce needles. The carrier fuel is feather moss and a lichen layer that has a tremendous surface-to-volume ratio with immediate responses to changes in relative humidity.

Although feather moss is a live fuel, it responds like a dead fuel to changes in weather conditions. When free of surface moisture, the response to change in RH would class feather moss as a 20 minute timelag fuel. With RH of 45 percent or less it will usually burn even if temperatures are cool.

Exhaustive studies have concluded that black spruce is always ready to burn at anytime. Even in a wet summer the spruce needles remain dry (70 and 80 percent live fuel moisture). Studies explain the problem faced by Alaska fire managers of having a crowning spruce fire at anytime, including the day after a good, soaking rain. Besides the 20 minute timelag for carrier fuels to dry and burn, we have the spruce with branches to the ground and needles with a live fuel moisture (70 to 80 percent) that is ready to burn. Within minutes, an individual tree or a cluster can be torching out. Added to this is nearly 24-hours of daylight, which minimizes the normal nocturnal effect. Don't expect a fire in black spruce to necessarily lay down at night.

Fuel Model #9, multiplied by a factor of 1.21, is used for the rate-of-spread. This fuel model exhibits one of the slowest rates-of-spread, and should help explain the earlier statement that labels spruce crown fires are seldom running crown fires, but are surface fires with the crown fire following a few feet behind. Fuel Model #5 is used for fireline intensity. This fuel model exhibits one of the highest fireline intensities.

These fuel models pretty well fit the type. The homogeneous fuel which is extensive and continuous presents an opportunity for the fire behavior analyst to make reliable calculations with a high degree of accuracy for entire days.

Again, the black spruce fire is carried by surface fuels with a crown fire following a few feet behind the fire front.

This is why retardant is effective in what appears to be a timber crown fire; the retardant stops the surface fire in the moss/lichen layer and the dependent crown fire dies.

Rate-of-spread is slow and predictable, while intensity is high. It is common to have spotting by aerial firebrands in a crowning spruce fire. This can occur regardless of the previous weather.

Wind is the crucial factor, with spotting occurring over 1/2 mile ahead of the fire and even up to 2 miles. With the right conditions the Yukon River can and has been jumped by aerial firebrands. Spot fires are often difficult to detect until they take off and start running. Fire breaks then are a matter of condition. If conditions are right for long range spotting your fire break must be burned out with enough separation to hold. Spotting distance determines the usefulness of firebreaks.

In summary, black spruce will exhibit extreme fire behavior when temperatures exceed 80 °F and RH's fall below 30 percent. Remember, that in this fuel type, it is not uncommon to have an extended rainy period followed by clear skies, a little wind, RH to 25 percent, and have spruce trees crowning out by mid afternoon

EXAMPLE: A fire that is lying down and appears to be no problem can be off and running within a few hours. This scenario has ruined the day for many firefighters in Alaska.

3. Hardwoods.

a. Description.

Birch and aspen are the primary hardwood species forming this Alaska fuel type. Found on better drained sites, they are generally an indicator of better soils and less permafrost.

b. Fire Behavior in Hardwoods.

Although this is a major fuel type, it is primarily useful for the fire manager as a target of opportunity and not a problem fuel. It is very similar to a western aspen stand. For fire behavior calculations we use Fuel Model #9, timber litter understory.

Hardwoods normally serve as a natural barrier and offer a firebreak in all but rare periods of extended drought. A crowning spruce fire will normally drop to the forest floor when encountering a stand of hardwoods.

There is little understory vegetation of dead fuels and normally higher humidity and lower temperatures due to the canopy cover. Fire in hardwoods will usually creep along the surface doing little damage and offering little danger to the firefighter. Difficulty may be encountered however, when grubbing the fire out from among the maze of roots. As more spruce appear in those closed stands, the behavior of a fire may become more erratic. The peat and moss in some hardwood areas can be quite deep burning. This presents a difficult mopup situation. Frequently, with deep burning in peat moss and hardwood roots, a hotspot can smolder undetected for days. Infrared for mopup is especially effective in these conditions.

4. White Spruce.

White spruce stands often meet black spruce stands near lakes or streams, and form a very different fuel situation than may be burning in the black spruce. Under most usual burning conditions, the white spruce stands are on wetter sites and fire often does not pass through, although there is often a large loading of down dead fuels in the white spruce stands. It should be noted however, that under very dry conditions and especially with steep slopes and strong winds aiding it, fire of extreme intensity in mature white spruce stands can occur. (Rosie Creek fire on the Bonanza Creek Experimental Forest, and parts of the Bear Creek Fire around Farewell.) When extended drought has occurred, white spruce stands should not be considered a fuel break or a safe refuge for firefighters. Also, resistance to control in such stands is extremely high, usually dictating some form of indirect attack if at all possible. Alaska does grow some very large trees on good sites! They usually do not burn, but when they do, they pose a very dangerous situation.

B. Topography.

Generally speaking, topography/terrain is not a major determinant of fire behavior in Alaska.

1. Fire prone areas are in flat and rolling terrain between sea level and 3,500 feet elevation. Above 3,500 feet there are no fire problem fuels. (Density altitude is not a problem for aircraft operations.)
2. As a rule, north facing slopes are poorly drained and underlain by permafrost, resulting in black spruce stands and south facing slopes are fairly well drained (especially the upper 3/4) resulting in more deciduous (hardwood) stands of birch and aspen.
3. River bottoms are characteristically meandering with stringers of taller white spruce that normally do not burn as a crown fire, but often have large amounts of heavy down and dead wood.

C. Weather.

There is no "typical" weather pattern for Alaska. A strong high pressure system can dominate for days with clear skies, warm temperatures and low humidities. Daily thunderstorm activity during these periods leads to multiple fire occurrence and fire blowups. The high pressure system can break down rapidly and cool, moist Arctic air can move in followed abruptly by a return of high pressure and good burning conditions. Weather prediction in Alaska is difficult and should be used with contingency for change.

1. Relative humidity is the primary weather factor that determines fire behavior. Below 50 percent RH, fires will burn in most heavier fuels and at 30 percent, fire behavior becomes extreme at warmer temperatures. RH rarely drops below 20 percent in Alaska.
2. Temperatures in summer normally range from 65 to 85 °F with occasional readings in the 90's. Extreme burning conditions occur in black spruce with temperatures 80 °F or higher when coupled with RH's below 30 percent.

3. Winds are generally varying depending on local terrain with no predominant wind flow pattern except near mountain ranges where glaciers and permanent snow fields on mountains can cool air masses causing down-slope flows. Afternoon and evening thunderstorms produce significant winds which adversely affect fire behavior.
4. The 24 hour daylight ("midnight sun") for most of June and July greatly decreases the nocturnal temperature and humidity differentials enjoyed in the lower 48.

II. STRATEGIES AND TACTICS

A. Strategies.

1. The most common strategy used for effectively containing large project fires in Alaska is indirect attack. Mechanized equipment, such as engines and dozers, is not readily available in large quantities in Alaska and due to terrain difficulties usually cannot be used effectively on most fire perimeters. Likewise, large numbers of hand crew personnel cannot be transported and easily supported along fire perimeters, requiring most perimeter to be covered on foot. These situations combine to make it infeasible to keep up with a running fire.
2. Direct attack strategy can be implemented when weather conditions reduce fire behavior to a level where black lining can be rapidly and thoroughly accomplished or when the fire perimeter has road access.
3. Often extreme fire behavior and/or limited suppression resources may require a strategy of defense of critical sites vs. offensive containment of the fire. Both direct and indirect attack can be applied in a defense strategy.

B. Tactics.

1. Direct Attack.

The most common method of direct attack consists of beating out the flame front with a "spruce bough" or wet gunny sack. Conventional back pack pumps and/or portable pumps are used but less extensively. Use of shovels is minimal and the pulaski is used primarily to cut spruce boughs or for mopup. Seldom is a line cut using a pulaski. Cold trailing is the most reasonable method of securing the line.

2. Indirect Attack.

Burning out from natural barriers or built line is most common. Smokejumpers on initial attack carry fusees and often use burnout on small fires to minimize hand line construction.

When fireline intensity or size of a fire dictates indirect attack methods, a number of options are available. Aerial ignition from a helicopter is usually a valuable time saving tool. In addition to normal line construction methods, burnout can be accomplished from:

- Fireline explosives built line.
- Retardant line.
- Wet line from FEDCO's or Hoselays.
- Walk down line.
- Brush line (bum and beat).

Common mistakes or problems in indirect attack:

- Not planning enough time or moving far enough ahead of the fire.
- Parallel line to white spruce, hardwoods, or other natural barriers. Line through black spruce instead of hardwoods, or tundra
- Fuels drying out faster than anticipated.
- Tundra not as easy as it looks (especially the difficulty in movement of ground crew).
- Retardant not always effective (especially in tussock tundra when it can burn under the retardant).
- Indirect attack can be a major gamble with weather. It may take a week to build the line and by then weather will permit direct attack on the main fire miles away. Weather can also prevent a clean burnout.
- Timing a transition to direct attack - better late than too soon.

C. Strategy and Tactics for Black Spruce.

Complex fires in black spruce - feather moss call for long range planning, use of natural barriers, and a constant alertness to the weather. Nearly all lines, constructed or natural, require burning out to hold. Patrols are necessary on a fairly continual basis as the exposed moss along trenched line ignites readily and spot fires can smolder for several days before "popping up". The use of natural barriers is the most positive means of control.

III. SPECIAL CONSIDERATIONS UNIQUE TO ALASKA

A. Safety.

1. Bears.

Black bears and grizzly bears are frequent visitors to incidents. Both can be dangerous! The best solution to avoid bear problems is to maintain garbage free, food clean camps and operations areas. If bears become a recurring problem, and therefore, a hazard, weapons and licensed hunters are available upon order.

2. Drinking Water.

Streams and creeks in Alaska are infected with giardia, and therefore, are not suitable for use as drinking water. There are several portable water filtration systems available for order, but if one of those systems cannot be obtained; then drinking water must be hauled to the incident. This may involve costly and scarce aircraft resources, but it must be done.

3. Fire Shelters.

In black spruce and tundra it is nearly impossible to cut a sufficient clearing through the vegetative ground cover to mineral soil for safe, effective deployment of a fire shelter. Escape routes and safety zones, often found in the form of shallow lakes and ponds, are a must.

4. Fatigue.

Mobility in Alaska terrain is often overestimated by the inexperienced observer. What appears to be a refreshing green meadow when viewed from the air, is usually an ankle, twisting, knee wrenching, muscle torturing obstacle course of tussock wetland covered with ankle to knee deep water. Working and foot travel in this type of terrain is difficult, slow, fatiguing and often hazardous.

5. Camp Supply.

The supply of camps is primarily by air transportation, and therefore, vulnerable to adverse weather and smoke conditions. Camps often go for several days without the availability of re-supply. A minimum supply level of three days of food and water should be maintained at all camps not accessible by road or boat. The minimum level needs to be confirmed, and if necessary restocked anytime weather or fire behavior forecasts indicate limited air operations.

B. Functional Considerations.

1. 24-Hour Daylight.

Remember, 24-hour daylight results in little nocturnal fire behavior relief; but, on the other side of the coin, it does allow round-the-clock operations (including air operations) with little concern for darkness limits.

2. Retardant Use.

The philosophy in Alaska is to make a major retardant commitment on initial attack. Due to long hauls and the resulting high cost, heavy air tankers are seldom committed to a single project fire, but are kept working new fires. You may be able to arrange through logistics for a tanker to secure a flank or burn out from retardant line. A helicopter and water bucket may be cost effective.

3. Native Crews.

The primary sources of Type 2 crews in Alaska are Emergency Fire Fighter (EFF) crews from rural native communities and villages. Village crews are trained to national standards with a crew leader from the village. Crew size is 16 due to limitations of transportation by Twin Otter aircraft,

4. Remote Camps.

Remote camps are difficult for many lower 48 firefighters to adapt to, but they are a must in order to maximize line production without wasted time moving crews by helicopter. Logistical support demands multiple camps on a large fire. Feeding and camp systems are designed for camp support.

5. Logistics.

- a. A 72-hour lead time is required on resource orders after the first 48-hours.
- b. Problems due to distance from headquarters supply point
- c. Food rations and fresh food boxes with no caterers or camp kitchens
- d. There is limited availability of helicopters.
- e. Radio communications - few telephones
- f. Showers are normally not available.

6. Aircraft Operations.

Probably no place is more dependent upon aircraft than Alaska. Some considerations:

- a. 24-hour daylight provides round-the-clock air operations. Double crew helicopters.
- b. After initial attack, most aviation work is logistical, not tactical (little bucket work, etc.)
- c. Density altitude is usually not a factor (most operations are below 2,500' M.S.L.).
- d. Distances are great!

- e. Supplying jet fuel for helicopters is a significant problem. Due to the remote nature of Alaska all helicopter contracts stipulate fuel to be provided by the government.
- f. There are no chase trucks. Fuel can be parachute dropped in 500 gallon rollagons and then sling loaded by helicopter to a fueling area. This is a significant workload and requires planning. There is a short supply of available helicopters.
- g. For remote fires and camps paracargo is significantly less expensive and time consuming than helicopter transport from an airstrip 30-50 miles away. All supplies can be delivered by the AFS paracargo unit which is the largest nonmilitary paracargo operation in the world. Consider drop zones removed from people areas and sling supplies from drop zones. Do not fail to allow for the workload of cargo and parachute retrieval.
- h. Allow for aircrew fatigue factor in a "bush" environment.
- i. The air tactical group supervisor dispatched with airtankers is also the lead or airtanker coordinator.
- j. Helpful Hints:
 - (1) Order an Alaska air support group supervisor, at least for the first 72 hours.
 - (2) Order a fueling specialist (this is a red-carded AK position).
 - (3) Zone air service managers are an important resource, especially for lower-48 teams.
 - (4) Don't fall behind the fueling power curve!!

C. Environmental Considerations.

1. Environmental Area.

Alaska is a very high visibility area for all the traditional environmental concerns and confrontations. Rarely are fire operations exempt from close environmental scrutiny. You are not "out of sight, out of mind"!

2. Dozer Lines.

Problems caused by dozer lines on permafrost have essentially eliminated their use in either remote or permafrost areas.

Fire managers must have the agency administrator's approval before use. When dozers are used, special procedures can avoid many problems which have created environmental concerns in the past. Often fire perimeter is inaccessible to heavy equipment.

IV. SUMMARY

Incident management teams and firefighters arriving in Alaska must adapt to many changes besides the mosquito population. They will probably find:

- A large fire size (25,000+ acres) with no natural barriers for many miles.
- Indirect attack with many miles to a natural barrier.
- Poor weather information.
- Extreme fire behavior in seemingly mild weather conditions.
- Many unfamiliar logistic problems.
- Lack of sufficient helicopters.
- Difficult communication to outside world.
- Highly variable burning conditions with minimum timelag for drying.

The most frequent management problem facing incident management teams and firefighters is developing strategy to protect resources from a large fire that is still five or more miles away. Strategic decisions are complicated by factors of inaccessibility, limited force availability, unique logistical concerns, and unpredictable weather.

NORTHWEST AND NORTHERN ROCKY MOUNTAINS

I. NORTHWEST

The Northwest area includes the Coast and Cascade Mountain Ranges of Western Washington and Oregon, and Del Norte and Humboldt counties of Northern California.

A. Topography.

Water, volcanic, and glacial events in this area have created a great variety of land forms ranging from coastal dunes to rolling hills and steep, highly dissected hillsides.

The major geological features are the Coast and Cascade Mountain Ranges. The Coast Range includes lower elevation mountains close to the coastline. The Cascade Range runs parallel to the Pacific coastline about 100 miles inland.

Other important land features are the Willamette Valley, Puget Trough and the Columbia Gorge which is a water gap through the Cascade Range. One active volcano, Mount St. Helens, is located on the Gifford Pinchot National Forest.

Unstable, or potentially unstable soils are extensive on all forested lands west of the Cascades.

Elevations range from sea level to 12,000 feet.

B. Climate.

Because of the maritime influence, coastal areas are comparatively warm throughout the winter. Rainfall is mostly concentrated in the winter months. Summer rainfall is usually very light.

Annual rainfall varies from 60 to 150 inches along the coast. The valley systems to the east of the Coast Ranges receive 30 to 50 inches in Washington and Oregon, and 15 to 20 inches in northern California.

The combination of high rainfall and moderate temperatures results in a buildup of extremely heavy fuel volumes. The maritime influence, particularly along the immediate coast, usually holds the fire danger to moderate levels during most seasons.

However, some summers are very dry and warm with high fire danger. During these periods, fires are characterized by high intensities, firewhirls, and long-distance spotting.

The fire season usually runs from June through September. Lightning fires increase in number and severity from the coast inland.

C. Fire Weather.

In northern California and in western Oregon and Washington, strong dry north to east winds may produce extreme fire danger in late summer and early fall. Two major weather patterns produce this critical fire weather.

1. One is a cold front passage followed by a Pacific high pressure system extending inland over the coast. The northeasterly winds blowing downslope produce a warming and drying foehn wind effect.
2. The second occurs when higher pressure develops east of the Cascades at the time lower pressure lies along the coast. The resulting dry easterly winds will cause high fire danger west of the Cascades. Northeast wind not only keeps the marine air offshore, but also results in adiabatic warming as the air flows from higher elevations down to sea level.

Critical Fire Weather - East Wind.

East wind in fire control means an exceptionally dry wind from an easterly quadrant that may blow continuously for 24 to 48 hours or longer. East wind often reaches maximum strength during night and early morning hours. Surface wind of 60 mph is not uncommon. It is accompanied by relative humidities that remain extremely low around the clock with relief only at night in some of the deeper ravines.

East wind frequencies over northwest Oregon and southwest Washington vary by month, and the pattern of monthly variation differs with elevation. September bears the greatest impact of easterly winds as they affect wildland fire control.

D. Major Fuel Types and Fire Behavior.

1. Douglas-fir/Hardwood

Natural fuel loading 3 to 33 tons/acre
Average duff depth 2 inches
Spread rate 2 to 10 chains/hour
Flame length 2 to 7 feet
Resistance to suppression 2 chains/person hour

2. Douglas-fir/hemlock

Natural fuel loading 14 to 330 tons/acre
Average duff depth 4 inches
Spread rate 1 to 17 chains/hour
Flame length 1 to 13 feet
Resistance to suppression 1 chain/person hour

3. Subalpine Fir

Natural fuel loading 3 to 36 tons/acre
Average duff depth 6 inches
Spread rate 1 to 6 chains/hour
Flame length 1 to 6 feet
Resistance to suppression 1.5 chains/person hour

4. Mixed Conifer

Natural fuel loading 7 to 56 tons/acre
Average duff depth 2 inches
Spread rate 1 to 7 chains/hour
Flame length 2 to 7 feet
Resistance to suppression 1.5 chains/person hour

5. Spruce-Cedar

6. Oak-Madrone

7. Activity Fuels

Douglas-fir/Hardwood - Clear-cut 50 to 250 tons/acre
Douglas-fir/Hemlock - Partial cut 10 to 100 tons/acre
Douglas-fu/Hemlock - Precommercial thinning 1 to 10 tons/acre

E. Strategy and Tactics.

Direct attack is used on most small fires and spot fires that are a result of a large fire caused by east wind conditions. Fires influenced by the east winds have numerous spots and a fingered fire edge.

Parallel attack is the method most commonly used on medium and large size fires. The average wildland fire burns intensely because fuel types and dense smoke prohibit direct attack. The key to success is anchor points and a well timed burnout.

Indirect attack is not commonly used unless needed to stop the spread of crown fire.

1. Tactical Considerations.

Dozers. In heavy fuels, such as in the Douglas-fir type or in lodgepole, larger bulldozers are particularly effective. Very little advanced clearing is necessary except bucking large logs. It is sometimes advantageous to work two heavy units in tandem so the forward movement is continuous. The first dozer pushes over standing material and the second pushes the debris aside and builds a wide fireline to mineral soil.

Snag Falling. In heavy snag areas, especially in Douglas-fir, a special safety problem is encountered. Many of these snags contain rotten wood and are prone to shedding bark in long sheets, with tops and limbs breaking off. These hazards are compounded when the snag is burning. As a result, local professional fallers should be hired and assigned a local falling boss who knows the local snag policy. Snags are a sensitive issue in the northwest. Most land management agencies have a protection policy.

Helitorch. Adequate planning and timing are critical to success. The helitorch may not be effective in old-growth stands due to a closed canopy in the timber.

Water. It is plentiful and commonly used. Engines, water tenders, hose lays with accessories are used throughout the area. All agencies have water handling specialists that can assist in the installation of progressive hose lays in the most adverse terrain. Heavy fuels in this smoke sensitive area

require an aggressive mopup policy built on the ability to move water regardless of the terrain. Firefighters and incident management teams should assess the water handling needs early and place a balanced order for equipment and personnel.

Air Operations. Air tanker drops are valuable in slash models, young plantations and for protecting high resource values. Old-growth canopies break up the drop patterns, usually making them ineffective.

Light helicopters are useful for scouting, air tactical safety lookouts and logistic operations. Because of the density altitude, and heavy fuels, water bucket loads on light helicopters are generally not effective.

Large and medium size helicopters with water buckets are effective in the various fuel types provided there is less than a 5 minute turnaround time from a water source. These bucket operations can be supported with fold-a-tanks for shorter turnaround times, thus reducing flight costs.

Many helicopter companies have buckets set up to utilize foam. Foam is very effective in light to moderate fuels with an open canopy.

Consider rappellers as an option for initial attack and/or construction of remote helispots. Keep in mind, the host unit may need to retain rappellers for initial attack.

Consider use of camps rather than daily movement of a large number of crews via helicopters.

2. Safety Concerns.

- a. Snags and large trees - use professional fallers.
- b. Heavy fuels - create dense smoke.
- c. Cable logging - cables across canyons.
- d. Blowdown from east winds - feet never touch the ground, rolling logs.
- e. Giardia lamblia - "Beaver Fever," water-borne parasite.
- f. Reburn after a ground fire goes through stand.

- g. Usually no night operation period on the Olympic Mountains because of **60** percent plus slopes, snags and heavy fuels.
- h. Fuels and terrain make LCES difficult to implement.
- i. Hypothermia - high elevations and rain.
- j. Logging trucks on single-lane, full bench roads.
- k. Power lines crisscross major drainages.

II. NORTHERN ROCKY MOUNTAINS

The Northern Rocky Mountain area includes:

- Eastern Washington and Oregon, and Northern California.
 - Idaho (area north of line from Boise to Yellowstone National Park), Montana, North and South Dakota
- A. Eastern Washington and Oregon and Northern California.

1. Topography and Climate

In eastern Washington and Oregon and northern California, elements of the continental Rocky Mountain forests meld with some of those from coastal areas. In addition, forest species mix with species steppe and shrub-steppe communities. The area is typical ponderosa pine forests. The area includes the Klamath Mountains in northern California which are characterized by rugged, deep dissected terrain and knife-like ridges. The Blue Mountains of northeast Oregon and southeast Washington have variable relief, ranging from moderate to steep with Hells Canyon comprising the eastern boundary of the province.

Central Oregon and northeastern California have high lava plains characterized by young lava flows of moderate relief, interrupted by scattered cinder cones and lava buttes. The surface layer of pumice varies from a few inches to 20 feet deep in places, and was deposited by air currents during the last major volcanic eruptions. This is a land where rocks float, wood sinks and soil burns.

The vegetation of northern California consists of grass in the lowlands, brush at intermediate levels, and extensive coniferous stands in the higher mountains.

The annual precipitation is generally light, around 10 to 20 inches at lower elevations. Precipitation in the mountains ranges up to 60 inches or more locally. Summers are usually rainless with persistent droughts common in southernmost sections. Widespread summer thunderstorms with little precipitation reaching the ground, particularly in the mountains of the northern half, occasionally result in several hundred fires within a two or three day period.

The fire season usually starts in June and lasts through September.

2. Fire Weather.

Several weather patterns produce high fire danger.

- a. One is the cold front passage followed by northeast winds, the same as was described above for the coastal region farther north.
- b. Foehn winds are created by the airflow around a high pressure system in mountainous areas. The airflow spills over the mountain range and downhill at a phenomenal rate of speed. This causes fuels to dry out. As the temperature increases, wind speed may reach 50 to 70 mph.

In Oregon, a foehn wind is referred to as an east wind. In northern California it is a north wind and in central California it is known as a Mono. In southern California the foehn wind is the famous Santa Ana.

Many of the largest, most damaging and most costly fires in Oregon, Washington, and California have been caused by foehn winds.

- c. A third pattern occurs when a ridge or closed high pressure system aloft persists over the western portion of the United States. At the surface this pattern produces very high temperatures, low humidities, and air mass instability.

Never assume general principles are absolute; on the Fremont NF in Lake County, Oregon, the Summers Lake/Winters Rim area has reverse diurnal winds. This rim on the West side of the basin has upslope winds at night and downslope winds during the day.

3. Forest Fuels and Fire Behavior of Eastern Washington and Oregon, and Northern California.

Following are the major natural fuel types. The fire behavior descriptions listed do not reflect the erratic fire behavior that may occur as a result of multiple years of drought and dying forests caused by insect infestations.

a. Lodgepole Pine.

Natural fuel loading 3 to 35 tons/acre
Average duff depth 0.6 inches (OR, WA, CA) 4.5 inches (N. Rockies)
Spread rate 1 to 12 chains/hour
Flame length 1 to 10 feet
Resistance to suppression 2 chains/person hour

b. Ponderosa Pine

Natural fuel loading 1 to 48 tons/acre
Average duff depth 1.5 inches
Spread rate 3 to 10 chains/hour
(Needle drape bitterbrush 40 to 50 chains/hour)
Flame length 2 to 6 feet
Resistance to suppression 2 chains/person hour

c. Activity Fuels

Lodgepole pine clear cut 16 to 40 tons/acre
Lodgepole pine partial cut 3 to 35 tons/acre
Ponderosa pine clear cut 22 to 46 tons/acre
Ponderosa pine partial cut 3 to 29 tons/acre
Ponderosa pine precommercial thinning 7 to 28 tons/acre

d. Brush Fields

Natural fuel loading 5 to 37 tons/acre
Average duff depth 20 inches
Spread rate 7 to 13 chains/hour
Flame length 5 to 7 feet
Resistance to suppression 1 chain/person hour
Generally not a fire problem. Brush fields are a result of old burns.

e. Mixed Conifer - Pine

Natural fuel loading 2 to 31 tons/acre

Average duff depth 1.5 inches

Spread rate 1 to 13 chains/hour

Flame length 1 to 7 feet

Resistance to suppression 1.5 chains/person hour

B. Idaho (area North of a line from Boise to Yellowstone National Park), Montana, North and South Dakota

1. Topography of Idaho.

Idaho - Includes portions of four major physiographic areas, the Northern Rocky Mountains; the Middle Rocky Mountains, Basin and Range, and the Columbia Plateau. Our area of concern is the Northern Rocky Mountains that occupy almost half of the state's area lying mostly north of a line from Boise to Yellowstone National Park. Within this area are some of the most inaccessible mountains in the United States. The Continental Divide is the boundary line between Idaho and Montana from Yellowstone National Park northwesterly to Lost Trail Pass. Fuels are heavier on the west side of the Continental Divide. Elevations range from 720 feet to 12,655 feet. Two major drainages, the Salmon River and the Snake River, both exceptionally deep canyons, flow through this region. Both of the canyons exhibit hazardous fire suppression conditions because of steep slopes, side canyons and inaccessibility and a local fire behavior analyst should be requested.

The Snake River in Hells Canyon is the border between Oregon and Idaho. Elevation varies between 550 feet and 7,900 feet with heavy fuels on the Idaho side and light, flashy fuels on the Oregon side. Most of the area is wilderness inside the Hells Canyon National Recreation Area.

2. Topography of Montana.

Montana - Topographically, the state is divided into two regions: east and west. The eastern portion is composed of rolling hills interspersed with low mountains, deep gorges, and unusual rock formations. These little pockets of mountains produce downslope winds all night, especially at the mouth of the canyons. Fires bum rapidly into the wind. West winds

come off the east slope of the Rockies and blow constantly. Fuels dry out quickly in June. Aspect can be used to your advantage when planning control tactics. Because of the extreme breadth of the state, 560 miles, it can be light in western Montana and dark in eastern Montana.

Western Montana is heavily forested. The mountains consist mostly of north-south ranges and are separated by broad, deep valleys and basins. All of the mountains were glaciated. Elevations in the state range from 1,820 feet to 12,799 feet. The Continental Divide runs north and south through the western section.

3. Climate of Idaho and Montana.

Winter temperatures are quite low, and summer temperatures are moderate.

Annual precipitation ranges from 10 to 20 inches in the valleys to 40 to 60 inches locally in the mountains. Most of the precipitation falls in the winter and spring in the southern portion of this area, while in the northern portion it is fairly well distributed throughout the year. Winter precipitation is in the form of snow. In the southern portion there often is widespread rainfall until June, followed by generally light precipitation during the summer.

4. Fire Weather of Montana and Idaho.

There is a gradual drying out of forest fuels during July and August with frequent thunderstorms producing lightning and starting fires. Extremely low humidities can result from large scale subsidence of air from very high levels in the atmosphere.

Occasional chinook winds on the east slope of the Rockies produce moderate temperatures and are effective in bringing subsiding air to the surface, which usually occurs in winter. The fire season usually extends from June or July through September. Catastrophic fire seasons usually begin with long term drought conditions for months before the outbreak itself.

This is an area of extreme weather conditions, especially east of the Continental Divide. Eastern Montana has an early fire season until greenup. The winds blow every day, 15 to 30 mph, until sundown.

There is a gradual drying out of forest fuels during July and August with frequent thunderstorms which produce lightning and start fires.

5. Major Natural Fuel Types and Fire Behavior - Idaho and Montana.

The overall fire potential ratings of nil to extreme are for an "average bad" fire weather situation defined as 80 to 90 degree F temperature (27 to 32 degree C), 15 to 20 percent relative humidity, 10 to 15 mi/h windspeed (16 to 24 km/h), and 4 weeks since a significant rain (0.10 inch (0.25 cm) or greater).

Overall Fire Potential Ratings

Nil - fire will not sustain itself.

Low - fire can be easily controlled by several firefighters with handtools.

Medium - aggressive initial attack required (6 to 10 persons) for successful control.

High - aggressive crew-size initial attack (25 persons) with substantial reinforcement required for successful control; 10 percent chance that initial control will fail.

Extreme - 90 percent chance that initial control action will fail. (Usually a two week period in a normal year).

a. Interior Ponderosa Pine

Natural fuel loading 1 to 11 tons/acre

Average duff depth 0.4 to 1.7 inches

Overall fire potential low to high

b. Ponderosa Pine-Larch-Douglas-fir

Natural fuel loading 2.5 to 38 tons/acre

Average duff depth 1.0 to 1.9 inches

Overall fire potential low to medium

c. Larch-Douglas-fir

Natural fuel loading 1.4 to 74 tons/acre

Average duff depth 0.5 to 4.6 inches

Overall fire potential low to high

d. Lodgepole Pine

Natural fuel loading 3.5 to 35 tons/acre

Average duff depth 0.7 to 2.8 inches

Overall fire potential low to medium

e. Engelmann Spruce-Subalpine Fir (The overall fire potential rating does not illustrate the erratic fire behavior caused by the change in fuel profiles as a result of the mountain pine beetle and spruce budworm).

Natural fuel loading 1.3 to 77 tons/acre

Average duff depth 1.0 to 5.0 inches

Overall fire potential low to high

f. Grand Fir-Larch-Douglas-fir

Natural fuel loading 16 to 38 tons/acre

Average duff depth 2 to 4 inches

Overall fire potential low to high

g. Western Hemlock-Western Red Cedar (Old-growth stands have a high percent of cull material).

Natural fuel loading 9 to 58 tons/acre

Average duff depth 2 to 5 inches

Overall fire potential low to medium

h. Interior Douglas-fir

Natural fuel loading 2.5 to 53 tons/acre

Average duff depth 0.3 to 3.0 inches

Overall fire potential low to medium

6. Strategy and Tactics.

a. Methods of Attack.

Direct attack (one foot in the black) is the preferred strategy. Cold trail when possible to avoid reburns escaping. Direct attack reinforced by a hose lay with laterals every 200 feet is very effective in most fuel types. Night work is very effective.

A guideline to remember concerning eastern Montana and the Dakotas is that sagebrush cannot be burned out when the relative humidity is over 30 percent.

When direct attack is not possible, parallel attack is usually successful. Position control lines as close to the fire's edge as possible. Fuels should be burned out as line progresses or as quickly as favorable conditions exist.

Indirect attack is used when erratic, severe, or extreme fire behavior occurs and displays one or more of the following conditions.

- Presence of fire whirls.
- Prolific crowning and/or spotting.
- Very high to extreme rates of spread.
- A tall, well-developed convection column.

b. Principles of Burnout/Backfiring

Aggressive direct attack and burning out as necessary is preferred, Conducting backfiring operations requires great care in timing. All the conditions must be right and all safety precautions must be in place.

Except in ponderosa pine/grass fuel types, constructing fireline in timber fuels several hundred feet or farther from the main fire and burning out or backfiring, generally results in spotty burn out/backfire and escaped fires.

Indirect attack and backfiring should be the last strategy used and must be approved in the Escaped Fire Situation Analysis (EFSA).

c. Tactical Considerations. Building fireline from the top down.

Sometimes it is necessary to construct a fireline downhill. This is a hazardous practice when done in fast burning fuels and steep topography, because of the danger that the fire may cross the slope below the crew and sweep uphill to trap them. A fireline should not be built downhill in steep terrain and fast burning fuels, unless there is no suitable alternative for controlling the fire; and then only when all safety requirements are

adhered to for downhill fireline construction (See also NWCG Fireline Handbook, Chapter 4, page 46.):

- d. Air Operations. In addition to the aviation considerations listed for the Northwest area, the following should be considered for the Northern Rocky Mountain area.

Nighttime inversion will hold smoke in valleys until mid or late morning and make air operations doubtful.

Air tankers have a low priority on large fires. In appropriate situations, aerial retardant can be effectively used for:

1. Holding action on small fires or spot fires.
2. Tactical support to line crews.
3. Pretreatment or indirect attack.

Paracargo for camp resupply is an option (24 hr notice required.)

When using dirt airstrips for crew/cargo transport, downloading or early morning or late afternoon flights may be necessary due to density altitudes.

- e. Critical fire problems are in lodgepole pine and lodgepole pine/subalpine fuel types where 50 percent of the lodgepole pine is dead and "jack strawed."

In these stands, tree moss and dead aerial fuels such as small twigs have the greatest influence on crown fires. Trees loaded with moss and lichens that extend from the tips of the trees to the ground present the worst conditions. Crown fires can start when a sufficient amount of ground fuels is present to carry fire to the aerial fuels. The problem becomes one of direct vs. indirect attack. The final decision is usually a combination of both methods based on safety, cost, values at risk and the ability to implement the decision in a timely manner.

- f. Canyon Country. A parallel or flanking strategy tied into good anchor points usually works best.

Tactical considerations:

1. Make sure you use a lead plane with air tankers for best result.
 2. Let fire come to the top, rather than build line downhill.
 3. Maximum, aggressive effort at night is usually successful.
 4. Make sure operation overhead and crew bosses working the night operational period have seen their assigned work area in daylight.
 5. Burnout is preferred to backfiring.
 6. If you are building line from the ridgetop to the bottom, find a side ridge that goes all the way. Burn out as you go, leaving a good clean edge with a solid black line.
- g. Safety Zones. It is essential to have firelines anchored to a safety zone or to create safety zones as work progresses along the flanks. Determining safety zone dimensions based on percent slope, height of adjacent timber and adjacent fuel loading is a critical assessment that must be done in a timely manner.
- h. Camps are often necessary to implement a strategy and are effective in reducing the fatigue of crews. Any time travel from the incident base to the fireline exceeds one hour, seriously consider establishing camps. (Camps are recommended, rather than helicopter troop movements.)
- i. Coyote tactics are sometimes necessary because of logistics. If coyote tactics are established they are often supplied with helicopter long lines. Timing of load, adequate water, and wash kits are critical.
- j. Dozer use. Bulldozers are in constant use for fire suppression in this geographic area because of heavy fuel complexes. Dozers are extensively used on large fires as the main line building method.

They are more likely to be used where fires have escaped initial attack, rather than during initial attack. Bulldozers are often used to reopen logging roads ahead of engines. Preconstruction of firelines around heavy slash concentrations is also a common application.

- k. Eastern Montana has large prairie fires from 300 to 1,500 acres that can be controlled with 20 to 30 people at night. Hit and run tactics are applied at the critical points in the fire perimeter. This type of tactic requires personnel and equipment to be highly mobile and have good communications with **all** units on the fire. If air tankers are used, 3 or 4 should be ordered at a time and lined up by a lead plane for trail drops. One air tanker is usually useless. Smoke jumpers are a good suppression force because of their mobility.

A real safety hazard in Eastern Montana and the Dakota's is pockets of surface gas in low areas. Pipelines and coal seams also present unique hazards. A "HAZMAT" specialist should be ordered if you are around any of these operations.

7. Key Areas of Concern.

- a. Safety (Helicopter evacuation and fire shelters are not acceptable escape routes).
- b. Snags - from old fires, bug kill, and drought conditions.
- c. Spot fires in subalpine types - aerial fuels and ladder fuels.
- d. Density altitude - helicopter limitation.
- e. Communications - difficult to establish in first 48 hours in remote areas.
- f. Avoid night work in cliff and heavy snag areas.
- g. Rock slides after fuel burns off steep slopes.
- h. Location of safety zones in dense timber areas. You cannot build them big enough. Indirect attack can get you in trouble.
- i. Wide variation of fuel types and arrangements.

j. Warning signs of long-range spotting or erratic fire behavior:

Relative Humidity, < 15 percent

Flame Lengths, > 8 feet

Live Fuel (foliage) Moisture, < 60 percent

10 Hour F.M. Below 10 percent

Windspeed exceeds 10 mph

1000 Hour F.M. is in 10 to 13 percent range

Watch your relative humidity recovery rate at night. If it is less than 60 percent, expect early, rapid burning.

k. Fire Whirls - E-W drainages.

l. Giardia lamblia

m. Bears are attracted by food, keep firelines clean.

n. Vertical mine shafts in many areas of the west. (Example: Black Hills of S.D.)

SOUTHERN AND CENTRAL CALIFORNIA

I. SOUTHERN CALIFORNIA

Southern California has had a long history of large and damaging fires. Some of the more notable include Laguna, 1970-182,000 acres, Marble Cone, 1977-170,000 acres, Panorama 1980-300 homes, the numerous fires in the fall of 1993 which burned over 200,000 acres. Deaths to firefighters include: Inaja, 1956-11 fatalities, Decker, 1959-7 fatalities, Loop, 1961-12 fatalities, Spanish Ranch, 1979-4 fatalities, Glen Allen, 1993-2 fatalities. Weather conditions, such as the Santa Ana winds, cause adverse fire behavior and rates of spread under severe conditions that may reach 6,000 acres per hour. These fires are further complicated by highly flammable fuel and steep topography.

Firefighters must be constantly aware of structures within the wildland. Virtually any escaped wildfire in which a Type I Team is assigned will involve a structural threat. During the fall of 1993, over 1,000 homes were destroyed between October 26, and November 4, through a series of fires in southern California. Even a relatively small fire such as the Sycamore fire, (1979-less than 1000 acres-245 homes) and the Paint fire, (1990-900 acres 641 homes) can present substantial structural protection problems. Whenever structures are threatened, numerous other agencies will most likely be involved and must be included in incident management operations.

For purposes of this information, southern California will include San Diego, Riverside, San Bernardino, Orange, Los Angeles, Ventura, Kern, Santa Barbara, San Luis Obispo, and Monterey counties. This area involves the Santa Monica Mountains National Recreation Area, Cleveland, San Bernardino, Angeles, Los Padres and Sequoia National Forests.

II. SOUTHERN CALIFORNIA FUELS

A. Chaparral.

Southern California fuel is dominated by brush but includes large areas of oak woodland and some small stands of timber. The term chaparral is often used to describe these fuels. Chaparral communities are generally bounded by timber stands above and grasslands below. Elevations where chaparral is found vary from about 500 to 5,000 feet. Chaparral is well adapted to fire and a fire every 20 to 30 years is necessary to keep it healthy.

Chaparral's relatively large amount of loosely arranged small material, much of it becoming dead as the plants mature, and its highly volatile oil content make it extremely flammable. Burnable chaparral fuel will average 15 to 20 tons per acre but can range from 2 to 40 tons per acre. After a fire, the chaparral is relatively fire-resistant for about 15 years. At about 20 years of age the proportion of dead fuels becomes great enough to support big fires under adverse conditions. As a consequence, the recurrence intervals of fires more than 5,000 acres is 20 to 40 years. Most fires in chaparral which exceed 30,000 acres occur in age classes greater than 30 years. Chaparral is Fire Behavior Fuel Model 4.

1. Chamise and Manzanita - The Primary Components.

Chamise is the most abundant and widespread of all chaparral shrubs in southern California. It usually occupies the drier, south facing slopes. Manzanita is the second most important group of shrubs and it usually occupies the more moist, north facing exposures. Chamise decreases in abundance with elevation and gives way to manzanita at higher altitudes.

2. Other Chaparral Fuel Components.

Other specific fuels included in southern California chaparral are buckwheat, sage (several types), scrub oak, and oak woodland sumac. There are many additional fuels; however, they don't match these in consequence.

B. Fuel Characteristics.

Grass in southern California usually begins to burn in May. Normally, chaparral will start to burn and sustain fire in late June or early July. The fire season ends around the first of December. However, major fires have occurred in January, February, and March. Chaparral fuels are relatively drought resistant; live fuel moistures may drop to 60% during critical periods. Dead fuel ratios will range from 15 to 50%, depending on the age of the fuel.

C. Chaparral Communities in Other Regions.

Chaparral is also found abundantly in Arizona. Arizona chaparral and California chaparral have common origins-on the North American Continent. Arizona chaparral differs from California chaparral as follows:

1. Arizona chaparral has a higher portion of sprouting shrubs.
2. Most of Arizona chaparral is on rough broken terrain at elevations that range from 3,000 to 6,000 foot elevations.
3. The upper elevations border ponderosa pine or pinyon juniper and the lower elevations border desert grassland or southern desert shrubs.
4. Arizona chaparral grows primarily during the summer whereas California chaparral grows primarily in the winter.
5. The fire frequency in Arizona chaparral is somewhat less than California chaparral. Although, we have identified some differences in California and Arizona chaparral, they are both dependent upon fire to remain healthy and behave very similarly under extreme fire conditions.

III. SOUTHERN CALIFORNIA FIRE TOPOGRAPHY

The topography in southern California is unique. It consists of coastal and inland valleys which lead to mountain ranges with elevations from sea level to 11,000 feet. The change in elevation from the base of the mountain slopes is very rapid; slopes in excess of 40% are common. This rapid change in elevation can result in fuel type changes over a relatively short horizontal distance. Most fires occur in the 1,000 to 5,000 foot elevations. East and north of the mountain ranges are primarily desert plateaus.

A. Topographical Features.

The topography consists of broken canyons with many steep side drainages. Such topography causes uneven surface heating, radical changes with fuel conditions, opposing wind directions and resulting erratic fire behavior. Other unique features include:

1. Chimney and chute canyons - Chimneys and chutes are common and vary in depth from a few feet up to 1,000 feet. Many firefighters have been killed in or above these topographical features, such as during the Loop Fire on the Angeles in 1966, when 12 firefighters died.
2. Steep rock areas - Steep rocky areas can make firefighter access difficult and provide additional safety hazards to personnel.

B. Access.

A good road system of major freeways, county roads and forest roads provide rapid access to many areas and also provides natural fuel barriers. Major roads are quite often used as control lines and anchor points. This is why engines are a primary suppression resource.

IV. SOUTHERN CALIFORNIA FIRE WEATHER

Annual rainfall in southern California varies depending on elevation, from 10 to 40 inches a year. From May until December little or no rain falls. Fuels at the lower elevations such as grass, light brush and desert fuels will burn early in the season. As the heavier brush dries out, depending on rainfall and weather, it will start to burn in June. A dry winter will cause an early season in heavy fuels but will reduce starts, spotting, and rates of spread due to less flashy fuel. The worst type of fire season for southern California is a wet spring, a hot dry summer, and Santa Ana winds. Such was the case during the bad fire years of 1967, 1970, and 1980. In 1993, southern California experienced a wet spring, a dry summer and Santa Ana Winds - over 200,000 acres were burned during the Santa Ana Wind events.

A. Temperatures.

An onshore weather pattern is standard through much of the early and mid-fire season. Temperatures vary, but as a general rule will follow this daytime pattern: 70 to 80 degrees in the immediate coastal areas (1-5 miles inland), 80-90 degrees in the coastal plains and valley areas, (5-20 miles inland), 80+ degrees in the mountain areas (20-50) miles inland and 100+ degrees in the desert areas (about 50+ miles inland). Night temperatures depend on the time of season but generally cool rapidly in the coastal and mountain areas, but remain warm in the desert during the summer months.

B. Humidities.

Humidities will range from 20-40 percent, depending on distance from the ocean. In coastal and inland areas humidity recovery is fast and can cause major problems with back fire and burnout operations. Use your slug psychrometer! Coastal fog will keep morning and mid-afternoon humidities up and temperatures down. Coastal fog usually occurs in May and June. Conditions at higher elevations maybe much hotter and drier than in coastal valleys.

Coastal fog may require the movement of aircraft from one location to another on the fire, and from one air base to another.

C. Wind.

Because of the relationship of the desert plateaus and the Pacific Ocean, the normal wind pattern is west or southwest. Winds will vary during the daytime from 5-15 mph. Due to surface heating in the inland valleys and desert, the onshore flow will increase during the afternoon hours. Downslope winds will start at dusk and be in the 5 to 10 mph range. They normally stop by dawn. This wind cycle is known as a diurnal variation. The downslope winds are strongest at the base of mountains and in river drainages.

D. Special Weather Conditions;

There are special weather conditions which are important to be able to predict and recognize. These conditions are as follows:

1. Santa Ana Conditions.

Santa Ana wind conditions occur when a high pressure system develops over the Great Basin area. Air will move from the high pressure system to the low pressure system over the Pacific Ocean. All aspects of the weather change as follows:

- a. Wind - The normal pattern of onshore flow reverses dramatically to a high velocity offshore flow. Santa Anas are a gradient foehn type wind which cause extreme fire conditions. The wind will blow from 30 to 50 mph, and has been known to gust to 90-100 mph. During the 182,000 acre Laguna Fire (1970), wind conditions were reported to be 80-90 mph and the fire spread at an average rate of 6,000 acres an hour (between 450 and 500 chains per hour) for 19 hours straight. The winds often blow strongest at night and during the early morning hours. During light Santa Anas, you may get a light westerly flow in coastal areas. These winds normally last for about three days. The last day of a Santa Ana will change to the regular onshore flow but will return the dry air that was pushed out to sea. This is sometimes called an ebbing Santa Ana.

This wind change will cause the fire to change direction and can pose a hazard to firefighters. You should closely monitor the predicted wind changes.

- b. Temperature - Temperature will gain about five degrees per 1,000 foot drop in elevation and will be in the 80's in the mountains and 90-100 degree range in the lower elevations.
 - c. Humidity - Humidity will drop rapidly with the onset of the Santa Ana. It may decrease to between 5 and 10 percent and has been recorded as low as 1 to 2 percent. Fuel moisture will also drop rapidly, especially in the 1 and 10 hour fuels and go down to the 2-5 percent range.
2. Sundowner Winds - The Sundowner is also a gradient downslope type wind. This special condition takes place in the Ojai and Santa Barbara front country some 90 miles northwest of Los Angeles. The difference with the Sundowner is the speed in which it develops and diminishes. The area in which Sundowners occur involve the steep slopes which rise immediately adjacent to the Pacific Ocean and the desert plateau immediately behind the mountain range. These two vastly different areas in close proximity cause a micro-climate to rapidly develop when there are temperature differences between the desert and the ocean front. The air in the micro high pressure flows to the micro low pressure area of the ocean front. This air flow is enhanced by the normal down canyon wind starting around sundown. The air compresses and heats as it flows down the mountain slopes toward the ocean. Sundowners have all of the same characteristics as Santa Ana's (temperature increases, humidity drops, etc.) but these events happen much more rapidly. Due to the rapid onset, Sundowner winds have caused fire deaths such as the Romero Fire in 1971, on the Los Padres Forest where four fatalities occurred.

V. SOUTHERN CALIFORNIA FIRE BEHAVIOR

Many firefighters have been killed in southern California. Fires run hot and fast. A typical fire from July through August with a normal onshore flow (10 to 15 mph) will burn 175 to 200 chains per hour with flame heights of 20 to 25 feet on moderate slopes. Spotting can be expected.

In September, October, and November, fires will burn 250 to 275 chains per hour with flame lengths greater than 30 feet. Moderate intermediate and long range spotting is common.

Wildfires in chaparral will slow and rapidly lose intensity as they reach the 5,000 foot elevation range. Normally, evenings will cool and fire intensities will subside substantially. Canyon bottom and mid-slope runs will still occur, however sustained runs with high intensities are the exception under normal conditions at night.

Unless the area is under extreme drought conditions, fires under normal onshore wind conditions will not continue to run or carry through the mixed conifer stands at higher elevations.

Under Santa Ana conditions, fires will burn with extreme intensity. These can occur at anytime of the year, but are most dangerous in the fall when fuel moistures are at their lowest. Rates of spread can exceed 1,000 acres per hour and flame lengths of 75 feet or greater are not unusual. Santa Ana conditions cause extreme burning at all hours of the night and day. Long range spotting up to a half mile or greater can occur.

Santa Ana fires are influenced by the wind with virtually no influence from topography. Once the Santa Ana Winds start to subside, there will be various wind changes from opposite directions as the onshore flow tries to overcome the high pressure air movement from the east. Fire behavior during this transition can be confusing and dangerous.

VI. SOUTHERN CALIFORNIA STRATEGY AND TACTICS

Strategy is the broad plan, tactics is what you do to carry out the plan. There is often much confusion concerning what are tactics and what is strategy. Strategy is usually the overall general plan. Tactics are the specific actions and methods to accomplish the plan.

A. Strategy.

Initial attack strategies in southern California include fast aggressive initial attack. Due to land ownership patterns and rapid rates of spread, fires usually involve several jurisdictions and threaten structures and other improvements.

Extended attack strategies include the 3 C's which are Confine, Contain and Control. Most fire situations in southern California will result in a control strategy. Because of the multijurisdictional involvement, and structures and improvements at risk, controlling the fire at its smallest practical size will usually be the general strategy.

B. Tactics.

Tactics are those specific actions taken to accomplish the overall goal (strategy). Your tactics will be based upon using the right equipment (both in quantity and type) to suppress the fire safely, and meet all of the incident objectives. Your tactics will be developed based on current and expected fire behavior.

1. Direct Attack.

In southern California it is always safest to employ direct attack. Because of the steep terrain, it is not always possible to see the entire fire. Because of the numerous canyons and broken topography, the wind can be erratic. Add to these factors the flashy, fast burning fuels and direct attack is obviously the safest tactic. In chaparral fuels it is always best to have "one foot in the black whenever possible. During Santa Ana Winds, it is best to flank the fire, as it is virtually impossible to stop the head of the fire during these conditions.

If the fire is too intense for direct attack, parallel tactics can be used. Parallel tactics involves getting far enough away from the fire to avoid the heat and still see it. Line is fired out as it is constructed.

2. Indirect Attack.

Indirect attack is usually employed when the fire is already large and other tactics are not safe or appropriate. It is risky and must be well planned with all of the necessary safety precautions including Lookouts, Communications, Escape Routes, and Safety zones (LCES) strictly adhered to. Burnout or back fire will normally be used in conjunction with indirect tactics. Burning must be well planned and executed. Burning must always be accomplished with favorable wind conditions, adequate resources and when the exposure of the fuels is appropriate.

Southern California fuels will often be difficult to ignite if they are shaded (cold) and will suddenly takeoff with greater intensity than anticipated once exposed to the sun (hot). Most of the firefighters killed in southern California have died during indirect attack operations. These include the Inaja 1956 - 11 fatalities, Decker 1959 - 7 fatalities, Loop 1966 – 12 fatalities, Libre 1968 - 1 fatality, Bell Valley 1972 - 1 fatality, the Spanish Ranch 1979 - 4 fatalities, and the Glen Allen 1993 - 2 fatalities.

When fire intensity is extreme, such as in Santa Ana conditions, the tactical posture may be primarily defensive rather than offensive, since the conditions make offensive tactics futile and dangerous. Protection of structures, critical watersheds or other values may be the only tactic that is attainable. As offensive opportunities present themselves, it will be important to be prepared with resources to take advantage of them. This posture may continue until the conditions change and the fire's intensity reduces.

3. Structure Protection.

Structure protection will quite often take away many of the wildland firefighting resources. You will have to make tough judgments on resource allocation. When possible, allocate structural protection to the local structural protection agency and when applicable involve them in a unified command structure. One of the biggest challenges an incident commander will encounter is attaining perimeter control when structures are involved. The best overall structure protection strategy is to control the wildfire.

Type 1 and Type 2 engine strike teams are often ordered for structural protection assignments. This type of equipment is usually readily available. However there may be times when a mixture of Type 2 and Type 3 engines may be more appropriate. When making tactical decisions consider:

- a. Firefighter Safety. **(ALWAYS OUR FIRST PRIORITY)**
- b. Rescue-Evacuation.
- c. Available Engines.
- d. Location of Homes.
- e. Roof Coverings.

- f. Rate of Spread.
- g. Direction of Spread.
- h. Engine Access.
- i. Water Supplies.
- j. Defensible Space.

4. Tactical Resources.

a. Engines:

The primary attack tool in southern California is the engine. There are literally hundreds available with quick attack times due to a good urban and mal highway system.

Wildland engines normally carry 500 to 1,000 gallons of water, a 250 to 500 gpm pump, and about 2,000 feet of hose plus handtools. Hose lays and mobile pumping is done on most fires. A number of wildland engines in southern California are equipped with Class A foam. Class A foam proved to be invaluable during the 1993 Santa Ana fires. The Los Angeles County Fire Department is currently equipping many of their engines with this capability.

b. Hand Crews.

Abundant in southern California.

- (1) USFS - 9 Hot Shot Crews.
- (2) CDF - 65 Hand Crews.
- (3) LA COUNTY - 30 Hand Crews.

All are fully trained and equipped, they have radios and are mobile.

c. Dozers.

Plentiful, several available from fire agencies for initial attack. Many rentals available; however, training may be limited. Size D-6 to D-7 is best for the fuel and terrain. Federal agencies have land management limitations on the use of dozers & almost all areas of southern California.

d. Aircraft.

Five air attack bases serve the area with 15 minute attack times. A number of these bases are jointly operated and staffed by CDF and the U.S. Forest Service. Aircraft types include C-130's, Orions, DC-6's, DC-4's and CDF S-2's. Terrain favors coordinated attack with aircraft and helitack crews. Approximately 15 initial attack helitack crews are available with both medium and light helicopters.

Normally, tactics will use a combination of all of these resources; engines, dozers, aircraft, and hand crews. At higher remote elevations, operations are usually limited to hand crews and aircraft.

5. Tactical Planning.

California fires move fast and constantly threaten improvements on multiple jurisdictions. It is important to have a person with local fire expertise for input to the planning process. Because of the frequency of fires in southern California it is also helpful to have burn history maps of the area. Fires in southern California often repeat themselves and reviewing previous burns in the same area may prove to be invaluable. Long range contingency planning is a necessity. You must have an idea of what your next move will be if current tactics fail. Including the other jurisdictional fire agencies into this process is also important. It is important to start your demobilization plan as early as possible. With vast amounts of resources that can be mobilized in a short period of time, it is key to start thinking about demobilization and priority releases as early on into the incident as possible.

VII. SAFETY CONSIDERATIONS

Firefighter safety will always be the primary incident objective. Some of the historical southern California safety problems include:

- A. Fireline safety - It is important to stress LCES (Lookouts, Communications, Escape Routes and Safety Zones). This is particularly important when any tactic other than direct attack is being employed. Numerous fatalities have occurred in grass and light flashy fuels with flame lengths of 4 feet. An area may look relatively calm and innocent prior to a change in factors which cause light fuels to make an explosive run. Light fuels react very quickly to changes.

As previously stated, during Santa Ana Wind conditions, you will often be in a defensive posture, flanking the fire as it heads in a very predictable direction. Problems can occur when a Santa Ana starts to dissipate and the onshore flow starts to return. This ebbing Santa Ana can result in wind changes which will turn a fire from a wind driven fire often burning down- or cross-slope back to a fire which is influenced by wind and topography. This can cause the fire to start burning back up the slope flanking itself. When Santa Ana's and onshore winds battle for control, a fire will run downslope with the Santa Ana influence and then run upslope as the onshore takes over. This can occur several times as the wind influence makes its transition.

The sundowner winds in the Santa Barbara area must always be considered. They will occur at dusk with little warning and cause strong winds from the north and east to run from the desert plateau to the ocean. Extreme fire behavior will occur.

- B. Air operations in southern California are complicated. Smog and smoke will often cause poor visibility. There are numerous private, commercial, and military aircraft in the area, along with dense populations and all of the associated hazards (powerlines, antennas, etc.). It is always important to have the Federal Aviation Administration declare temporary flight restrictions over and around the fire. Because of the numerous low level military training routes in southern California, it is important to double check with the military to assure they are aware of the restricted air space.
- C. General kinds of fireline safety issues include;
 - 1. Heat Exhaustion - Make sure firefighters drink and carry sufficient fluids. Heat exhaustion is a common problem.
 - 2. Critters - Southern California has poisonous rattlesnakes, scorpions, ticks and bees. Persons who are allergic to insect bites should carry medication for anaphylactic reactions. The Pajahuello tick can cause severe damage to surface skin and underlying tissues; Lyme disease can be a serious long term health hazard. Proper clothing and sleeping arrangements will help prevent bites. Stay away from rodents and rodent burrows, hantivirus is beginning to be a serious problem throughout California
 - 3. General Hazards - Uneven terrain and rolling material often result in ankle injuries, blisters and cuts from handtools.

4. Poison Oak - Southern California has poison oak. It is usually found in or near shaded areas where fuels are more moist.

VIII. CENTRAL CALIFORNIA

Central California also has a history of large, damaging fires. For purposes of this information, central California will include the Sequoia, Inyo, Sierra, Stanislaus, Eldorado, Tahoe, and Lassen National Forests, Yosemite and Sequoia/Kings National Parks (Central Nevada Range). Low frequency, high intensity large fires are the historic pattern. This pattern can often be associated with drought conditions and lightning storms; however, human caused ignitions have resulted in large damaging fires. Structural threats can be a protection problem, but somewhat different than southern California. Southern California structures are often found densely packed at the base of foothills. Central California has some areas like this however, much of the problem consists of small communities tucked in the woods. Numerous houses and cabins can also be found isolated throughout the area. Commercial timber, spotted owl habitat, archeological sites, wilderness area and other natural resources are often the protection priorities. Central California wildfires are often characterized by heavy fuels, burning intensely in remote areas. Logistical support problems can be a difficult challenge.

IX. CENTRAL CALIFORNIA FUELS

The Central Sierra Range consists primarily of grass and oak at the lower elevations, mixed brush at the intermediate levels and coniferous stands at the higher elevations. The eastern side of the Sierras is dryer and consists of sage transitioning into ponderosa and Jeffrey pine at higher elevations. Mixed conifer fuels present the primary fire problem in the Central Sierra Range.

A. Oak woodland.

Oak and grass lands will be found at the lower elevations up to 2,500 feet. These fuels occur primarily on the west side of the central Sierras. Oak grass lands are Fire Behavior Fuel Model 1 with fuel loading less than one ton per acre. Wildfire is carried through the fine grass fuels. Fire spreads rapidly and responds well to direct control efforts.

B. Mixed brush.

Mixed brush (chaparral, deer brush, ceanothus and manzanita) can be found at the intermediate elevations on the west side of the Central Sierras. Mixed brush in the Central Sierras can often be accompanied by a timber overstory.

Mixed brush exists between 2,500 and 4,000 feet, it is a combination of Fire Behavior Fuel Models 2 and 4; with a fuel load that ranges from 10 to 20 tons per acre. Wildfire can spread moderately through these fuels and be very difficult to control.

C. Sage.

Sage can be found at the lower to intermediate elevations on the east side of the Central Sierras. Sage is Fire Behavior Fuel Model 2; its fuel load is less than one ton per acre. Sage can burn at a moderate rate of spread, but usually requires a moderate wind to spread. Sage has little continuity on the east side of the Sierra range.

D. Mixed Conifer.

Mixed conifer can be found from approximately 4,000 to 9,000 feet elevation. Mixed conifer is Fire Behavior Fuel Model 10, with a fuel load that can range from 10 to 50 tons per acre. Duff layers (compressed pine needles and organic matter) can range from 2 inches to 6 inches in depth. Mixed conifer in the central Sierra Range consists of Jeffrey pine, white fir, Douglas-fir, incense cedar, red fir, white pine and ponderosa pine. Mixed conifer fuels present the most difficult fire problem in the Central Sierra Nevada Range. The worst or most hazardous mixed conifer fuel is:

1. A combination of young to moderate reproduction and mature conifer. This provides ladder fuels to the crown of the mature conifer.
2. A combination of mixed conifer fuels combined with a mixed brush understory. Once again this provides a combination of ground and crown fuels.
3. Mixed conifer fuels when the 1000 hour fuel moistures dip down into the low teens. Fuels become explosive at this fuel moisture content.

X. CENTRAL CALIFORNIA TOPOGRAPHY

The topography in the Central Sierra Ranges ranges from 2,000 to 13,000 feet elevation. The east side of the range is primarily desert, the west side is primarily grassy valleys and farmlands.

A. Topographical features.

The topography consists of steep slopes, valleys, and canyons. In most of the Central Sierras, lakes, streams, and ponds are plentiful. The mountain range runs north and south with numerous canyons and valleys facing east and west.

B. Access.

Access consists primarily of some paved roads, logging roads and hiking trails. Helicopter transportation and walking can be primary transportation modes. Fires with limited access present substantial logistical problems.

XI. CENTRAL CALIFORNIA FIRE WEATHER

The annual rainfall averages 10 to 20 inches at the lower elevations and from 30 to 40 inches at the upper elevations. From July to September, rainfall is minimal. Most large fires occur between late July and late October.

A. Temperatures.

Temperatures at the lower elevations range from the mid 70's to the mid 90's. Temperatures can exceed 100 °F under extreme conditions. At higher elevations (above 6,000 feet) temperatures range from the high 60's to the low 80's. Temperatures can drop below freezing at night at higher elevations.

B. Humidities.

Humidities can range from the mid 20's to the high 30's under normal conditions. Humidities can drop to the low teens during extreme conditions.

C. winds.

Average winds range from 7 to 10 mph out of the south, southwest under normal conditions. A frontal wind (in conjunction with the passage of a weather front) can create wind speeds in excess of 30 mph.

D. Special Weather Conditions.

1. The most common special fire weather conditions are thunderstorms. Thunderstorms are a source of fire ignition and cause erratic winds from unpredictable directions.
2. Another special weather condition is "mono" or east winds. These gravity winds are usually associated with a high pressure system moving southeast across Washington and Oregon from the Gulf of Alaska. Humidities drop, temperatures rise and winds can blow in excess of 30 mph. These conditions occur most often in spring and late fall. A wildfire under these conditions, particularly in fall, can be very intense and difficult to control.

XII. CENTRAL CALIFORNIA FIRE BEHAVIOR

Wildfires in mixed conifer fuels burn hot at moderate rates of spread. Average chains per hour range from 10 to 15. This can increase dramatically when spotting begins to occur. A typical wildfire in mixed conifer fuels will burn hot and be influenced by slope during peak burning periods. At night the fire will lay relatively dormant until mid-morning and repeat the pattern. This pattern is often complicated by thick smoke inversions in canyons and draws. During drought conditions, extremely - intense burning can occur in mixed conifer fuels. Convection columns can rise in excess of 35,000 feet. After an intense fire run, the convection column will flatten out or break up. When this occurs it can result in numerous spot fires sometimes miles in front of the fire. This will often result in a number of fires which leave difficult control and mopup problems.

Spotting is always a problem in mixed conifer fuels. Currently, as a result of many years of drought, dead fuels are abundant. There are pockets, 30 to 50 acres, of standing dead material. Fire, as it spreads into these areas burns intensely and sends bark platelets high into the convection column. This results in unusually violent fire behavior and long distance spotting. Due to heavy duff layers, mopup will be difficult and require significant time.

Mixed conifer fuels with young reproduction or with mixed brush always present a potential for re-burns. A wildfire may burn through the brush or smaller fuels and later run through the overstory. This is always a dangerous possibility for firefighters.

XIII. CENTRAL CALIFORNIA TACTICS AND STRATEGY

A. Strategy.

Strategy, as previously stated is the overall plan. Strategies in mixed conifer fuels may be somewhat different than those of chaparral. Fires in mixed conifer fuels usually require thinking bigger and looking for opportunities well out in front of the fire.

B. Tactics.

Tactics are those specific actions taken to accomplish the overall strategy.

1. Direct attack.

The best method for attacking fires in mixed conifer fuels is direct attack. This may not always be possible. If the fire demonstrates any of the characteristics listed below, direct attack may not be possible.

- a. Running in the crown
- b. Long distance spotting
- c. Substantial convection column
- d. Influenced by mono and east winds
- e. Burning in heavy logging slash or windfall

2. Indirect.

If direct attack is not possible, a combination of parallel attack on the flanks and indirect on the head may be necessary. It is critically important to build long range contingencies. Look for topographic opportunities in front of the fire which allow sufficient time to execute. Backfiring operations must be well planned and carried out only under ideal weather and burning conditions. If the fire is running and spotting, backfiring operations may make the situation worse. Consideration should be given to burning at night, if practical. In many cases it will require a change in the weather conditions which are causing the extreme burning conditions before you will be successful in halting the spread of the fire. It may be important to think in terms of 72 hours rather than 12 or 24.

Mopup will be a difficult job. All fireline should be black and mopped up entirely 100 feet inside. If foam can be used, it will make the job easier. (Mopup in these fuels is very difficult.)

3. Tactical resources.

- a. Hand crews - In large fire conditions, hand crews will be one of the primary resources. It is not uncommon for fires to be in remote areas with limited road or heavy equipment access. There are numerous crews available in California.
- b. Dozers - If the topography permits, dozers will be invaluable. They will be particularly important in implementing contingency plans where firing from a wide fire break is required.
- c. Aircraft - Aircraft will be vital; both fixed and rotor wing. Airtankers will assist not only supporting crews, but in knocking down spots. Rotor wing will be necessary for tactical operations as well as logistical operations. Crew transportation will most likely be accomplished with helicopters. Remote camps and coyote tactics may be necessary. Helicopters will be key to the success of these operations. Aerial ignition for firing operations may also be required. Heavy lift or Type I helicopters are very effective for water and retardant dropping in mixed conifer fuels.
- d. Engines - Fire engines will be useful if the fire is accessible or if structures are threatened. Engines are normally plentiful in California.
- e. Smokejumpers - Smokejumpers are usually used in initial attack operations. Smokejumpers may be helpful in jumping or rappelling into isolated spot fires if this can be accomplished safely.

XIV. SAFETY CONSIDERATIONS

Firefighter safety will always be a primary incident objective. Historical safety and special concerns in mixed conifer fuels include:

- A. L.C.E.S. - Lookouts, Communications, Escape Routes and Safety Zones are critical considerations in mixed conifer fuels. Visibility is often very poor due to the canopy and indirect or parallel tactics are often employed.

- B. Snags - Snags have caused many injuries and fatalities. Snags are one of the most important fireline safety considerations in mixed conifer fuels. This becomes increasingly more important and dangerous during night operations.

Due to recent drought conditions, numerous pockets of snags exist. Potential problem snags should be flagged along the fireline or anywhere crews may be working or walking. Night operations may have to be reduced to monitoring if the problem is significant.

- C. Mono-winds - Mono or east winds cause humidities to drop and the temperature to rise. Fires will burn intensely and spread with the wind which can exceed 30 mph. These conditions develop when a high pressure system moves from the Gulf of Alaska south and east across Washington and Oregon. It can be dangerous when this situation develops and diminishes during fire operations. Fire spread will change from slope and topography influenced to wind driven. This change can occur quickly and if not anticipated, could place firefighters in jeopardy. Reburn potential becomes greater during these conditions.
- D. Dehydration - Fires in mixed conifer fuels often occur under hot dry conditions at higher elevations. Firefighters need to carry sufficient water. Keeping camps and fireline helispots supplied with water will be important.
- E. Critters - Rattlesnakes, scorpions and ticks (including ticks with Lyme disease) are potential problems. Bears may be found in some locations but are not normally a problem. Hantavirus is a significant problem associated with rodents and rodent burrows. Avoid contact, be sure to have safety officers work with local health professionals to determine how to best mitigate hantavirus exposures.
- F. General hazards.

Steep terrain, heavy fuels, camp operations and long duration fires result in fatigue, cuts, bruises, muscle pulls, colds, etc. Minor burns are often experienced due to burning stump holes.

GREAT BASIN AND SOUTHERN ROCKY MOUNTAINS

I. FACTORS INFLUENCING FIRE BEHAVIOR IN THE GREAT BASIN AND SOUTHERN ROCKY MOUNTAINS

A. Topography.

1. Elevation: Elevations of major landforms in this geographic area range from about 2,000 to 14,000 feet above sea level.
2. Landforms: Major landforms found in these areas include the full spectrum of broad valleys to mesas, and mountains, varying in elevation and steepness. Most mountain ranges are oriented north and south with the Uintah Mountains in northeastern Utah the only exception.

B. Weather.

Because this area experiences a continental climatic influence, it is subject to extended duration of hot, dry, and windy weather with frequent thunderstorm activity throughout the summer.

1. Precipitation: Precipitation varies in amounts from about 4 to 25+ inches per year. In the Great Basin area, western Colorado, and high mountainous areas of Colorado, the majority of precipitation is received in winter in the form of snow and rain, depending on the elevation. March is quite often the heaviest precipitation month. But, along the Front Range foothills of Colorado, east of the Continental Divide, at lower elevations, the majority of precipitation comes in form of rain during the late spring/early summer months. In this area, May is usually the heaviest month of precipitation. This condition sometimes, although not always, results in lower elevations experiencing a facsimile of a split fire season. When early springtime conditions remain dry, fast spreading fires can be supported by dry vegetation in late March and early April. The occurrence of this situation diminishes with late spring plant growth but returns in July and persists throughout the fall or until the first snowfall.
2. Relative Humidity: Relative humidities can drop to minimums in the single digits with nighttime recovery ranging to 25 – 30 percent. Fire behavior is generally greatest at lowest levels but can occur up to 30 - 35 percent. Above this level, spread, and intensity are markedly reduced, although strong winds can

sometimes overpower the dampening effects of humidity. An example is the fact that sagebrush stands can be consumed with significantly intense headfires at relative humidity levels in excess of 30 percent in the presence of winds in excess of 20 mph.

3. Temperatures: During July and August, maximum temperatures can reach 80 - 100 degrees with minimums 30 - 50 degrees lower. (Minimum temperatures can drop below freezing and even into the teens. Snow can occur at higher elevations during any month of the year.)
4. Winds: Upper air flow generally originates from the west to southwest and moves to the east to northeast. Surface winds vary greatly, are affected by local terrain, and afternoon surface winds of 10 - 20 mph are common. Winds associated with the passage of thunderstorms can reach higher levels for short durations and often have significant effects on fires. Dust devils are common, and dry cold fronts frequently affect active fires.
5. Storm Tracks: Storms track into the Great Basin from the southwest and affect southern and western Nevada, from the northwest into southern and central Idaho, and from the south and west into Utah. The southern Rocky Mountain area is predominantly affected by storms tracking from the west and southwest into Colorado traveling to the northeast. The extreme southern portion of the state will receive an influx of monsoonal moisture from Arizona and New Mexico during July and August. Occasionally, a low pressure in northeastern New Mexico or the panhandle of Oklahoma will cause an "upslope" condition along the Front Range. This is where the counterclockwise flow of air brings moisture from the south into eastern Colorado directly into the Rocky Mountains from the east. This situation, however, is usually associated with high amounts of precipitation.

6. Storm Frequency: Thunderstorm frequency increases as the summer progresses. Moisture associated with thunderstorms A - varies but is greatest at higher elevations. In the Great Basin or western portion of this geographic area, thunderstorms will persist into August and early September while in the Southern Rocky Mountain portion, thunderstorms begin in late May and persist until mid-August, then drop dramatically in occurrence.
7. Day lengths: Generally, daytime hours are fairly long but traveling from south to north in the area will increase the daylength about one and one-half hours. This impacts suppression operations in that the peak burning activity occurs at different times and can affect operational period crew changes, etc.

C. Fuel Types and Fire Behavior.

Vegetative structure and composition in the Great Basin and southern Rocky Mountains are closely related to elevation and precipitation variances. Temperatures increase, precipitation decreases as elevation decreases causing less occurrence of woody tree species, and greater dominance of woody shrubs and grasses. These vegetative communities contain lower fuel quantities and tend to support fires with rapid rates of spread but of short duration. Containment actions are less rigorous than for heavier fuel types and mopup activities are minimized.

As elevations increase, temperatures drop somewhat, precipitation amounts increase, and vegetative types show a shift to forest communities. These communities possess greater quantities of fuel, both alive and dead. Slower rates of spread are common for fires in these areas, but intensities can escalate dramatically, and burnout of residual fuels after passage of the flaming front can be of long duration necessitating extensive mopup actions. The following sections provide a description of each major vegetative type, and its influence on fire behavior. Due to marked differences between fuels in the Great Basin area and the southern Rocky Mountains, they will be discussed separately.

1. Great Basin Fuel Types.

- a. Desert: True deserts are located in isolated places within the Great Basin, but present very little problem in terms of fire management.

b. Salt Desert Shrub:

- (1) *Description:* These communities occupy transitional zones between sagebrush-grass and true desert communities. They are found at the lower levels of the elevational gradient, elevations 2,000 - 4,000 feet, with annual precipitation amounts of 6 inches and less, and experience maximum temperatures of 85 - 100 degrees. Fuel loadings are low, with woody shrubs comprising the dominant component, but these shrubs do not commonly achieve high crown cover levels. Understory herbaceous plants are minimal. Natural barriers are common.
- (2) *Fire Behavior:* Due to the sparseness of understory fuels, surface fires seldom attain any size of consequence. The presence of wind is required to move fires between shrub crowns and sustain any major fire spread. However, fuel limitation and natural barriers commonly inhibit fires from affecting extremely large areas. Head fires are the most common type of fire and with strong winds can exhibit flame lengths approaching 20 feet with rapid rates of spread.

c. Grasses:

- (1) *Description:* Small isolated pockets of native grasses with few woody shrubs occur throughout the Great Basin. These areas do not represent a fire problem. Following fires in sagebrush communities, the woody shrubs are typically removed from a site returning it to grass dominance. In some areas, perennial grasses will dominate while in others, annual grasses, principally cheatgrass, will achieve rapid dominance. During the last 20 years, many wildfires have been reseeded with crested wheatgrass and large monocultures exist. Recently, rehabilitation efforts involve the use of native species.

- (2) *Fire Behavior:* In a cured stage for both annual and perennial grasses, rates of spread can be high but fires are relatively easy to control. Large areas of cheatgrass pose particular concerns because they reach a cured stage very early in the summer and remain very flammable throughout the fire season. With high temperatures, low relative humidities, and strong winds, fires in grasslands can produce flame lengths that prevent direct attack with handtools and rates of spread that are very high. Safety is a particular concern in these situations because escape routes and safety zones are few and when present must have quick accessibility. Crested wheatgrass monocultures are thought to be somewhat resistant to fire spread because of the maintenance of high fuel moisture contents but during dry summers they can support active fire spread.

d. Northern Desert Shrub:

- (1) *Description:* This vegetation community represents a dry steppe community found between the desert and pinyon-juniper communities. This community occupies large areas within the Great Basin and is also where the largest number of wildfires occur. Elevations range from 2,500 - 5,000 feet, annual precipitation varies from 6 – 10 inches, and maximum summer temperatures commonly reach 80 - 95 degrees. Sagebrush is by far the dominant species with associated species including rabbit brush, bitterbrush, snowberry, other sage species, various annual and perennial grasses, and forbs. Summertime periods are generally hot and dry with very low relative humidities. Fuel volumes will vary significantly depending upon site, its moisture regime, and human influences. Under moist conditions, sagebrush can attain a height of 8 feet but 3 – 4 feet is the norm.

- (2) *Fire Behavior:* In areas where livestock grazing is deferred, or where a winter allotment exists, summer conditions include high amounts of understory grasses and forbs. This fuel continuity strongly contributes to surface fire spread. In areas where this surface fuel continuity does not exist, wind is required to move fires between individual sagebrush plants. Fuels are represented by fuel models 2 and 5. Flame length usually varies from 3 - 15 feet with rate of spread being strongly affected by terrain and wind. Head fires are most common, nighttime humidity recovery is sometimes slight enough to permit continual burning activity. Thermal belts will also maintain an active fire. Spread rates are high, burned areas can reach 5 -10,000 acres in a single burning period. With critical conditions, burned areas can go much larger in a single burning period.

e. Pinyon-Juniper:

- (1) *Description:* Pinyon-juniper communities cover large areas in the Great Basin, occupying a transitional zone between sagebrush communities, and higher elevation montane conifer forests. Pinyon is the dominant species as elevations increase, and juniper assumes the dominant role at lower elevations. Western juniper is the only species occupying this zone in southeastern Oregon, and southwestern Idaho as the pinyon component drops out this far north. Associated species found in this zone include sagebrush, other woody shrubs, grasses, and forbs. Generally understories are sparse with this condition escalating the older the stand is. Young stands commonly have a large understory component, usually dominated by sagebrush and other shrubs. Environmental conditions common to this zone include: elevations 4,000 - 7550 feet, annual precipitation 10 - 16 inches, maximum summer temperatures 70 - 85 degrees.

- (2) *Fire Behavior:* Fire behavior fuel models 2 and 6 best represent this community. The sparse understory strongly controls the ability of these communities to support surface fires. Fire burning out of another fuel type into this one can travel into it in surface fuels, but seldom can sustain this for very long. The arid nature of the environment combined with the small stature of these trees makes total crown closure a rarity, thus when crown fires do occur, they are totally dependent upon strong winds to sustain their existence. High quantities of dead and downed fuels in old stands, high quantities of resin, pitch in pinyon trees, and low moisture contents of juniper trees as well as their shreddy bark make this woodland zone a very flammable situation. In the presence of strong winds, 25 - 50+ mph, independent crown fires occur that can cover large areas, 1,000+ acres, but natural barriers and fuel changes are common and limit spread. Spotting can be a problem but without wind can be easily dealt with. Wind is the key element in these communities, fires are either a single tree, low intensity event, or a wind-driven, high intensity event covering large areas.

f. Ponderosa Pine/Douglas-fir:

- (1) *Description:* These montane communities comprise a significantly important portion of the Great Basin area. These communities are found between the pinyon-juniper woodlands and the subalpine zone. Within this area, 75 - 80 percent of all extended attack and/or team-action wildfires occur in the Great Basin. These communities occur between 5,500 and 8,000 feet, are comprised of ponderosa pine, Douglas-fir, occasional lodgepole pine, and isolated aspen trees. Understories vary significantly with drier sites having grass-needle understories to those having dense tall shrub understories in heavily shaded conditions. Slopes range from very steep to gentle. Activity fuels and plantations can be present but do not pose any

particular problems in this geographic area. Annual precipitation ranges from 12 - 20 inches and maximum summer temperatures are found in the range of 70 - 85 degrees. Fuel complexes in these communities have been markedly altered in some areas through fire suppression, grazing, timber harvesting, insect, and disease occurrence. Open stands having low accumulations of down and dead woody materials have been changed to areas characterized by numerous dead overstory trees, shade tolerant regeneration abundant in the understory, heavy accumulations of surface fuels, high vertical, and horizontal fuel continuity.

- (2) *Fire Behavior:* Fire behavior in these communities ranges from low intensity surface fires in needlegrass fuels to all types of crown fires. The specific fire type that will occur is dependent on the fuel availability, fuel quantities, environmental conditions, topographical conditions, weather conditions, and present stand structure. All types of fires, (heading, backing, flanking, and crown) can occur with active burning possible throughout nighttime periods and sustained by thermal belts. Nighttime inversions develop frequently in valleys but fires can sustain activity above the inversion on slopes. Of special concern is the speed with which a fire can change from a benign surface fire to a fast-moving, high intensity, crown fire. Safety considerations regarding this potential are paramount, fire behavior predictions are an extremely valuable part of incident action plan development, and implementation.

g. Subalpine Communities:

- (1) *Description:* This fuel type covers a relatively small area at higher elevations within the Great Basin, but fires that do occur here are often difficult, and expensive to suppress.

High elevation communities are comprised of Englemann spruce and subalpine fir, with some lodgepole pine present. Surface fuels can be minimal in open grown stands or very heavy, predominantly large down tree stems, in closed canopy stands. Tree limbs of both species of trees usually are present all the way to the ground, posing good vertical fuel continuity.

Fire Behavior: These stands often burn in patchy, spotty patterns best described as hundreds of spot fires. Regular line construction and burnout efforts are ineffective on fires in this type. Spread is by torching of individual trees or groups of trees with spotting into more individual trees downwind. Retardant is seldom effective. These fires have the potential to wear crews out especially in low relative humidity situations with the constant torching and spotting into new fuels. Heavy down fuels, deep duff layers, and dense stands can make fire suppression a very laborious process. The key to suppression in this type is having crews limb up all trees with fire under them, to remove the ladder fuels, stop the torching, and spotting into new fuels. Once spread is stopped, water from pumps, engines, foldatanks, and bladder bags can be used to speed up the mopup in deep duff and heavy downed materials under the trees.

2. Southern Rocky Mountains Fuel Types.

a. Salt Desert Shrub:

- (1) *Description:* These communities occupy arid locations within the sagebrush-grass and grassland communities. They are found at the lower levels of the elevational gradient, elevations 4,000 - 5,000 feet, with annual precipitation amounts of 7 inches and less, and experience maximum temperatures of 85 -100 degrees. Fuel loadings are low, with woody shrubs comprising the dominant component, but these shrubs do not commonly achieve high crown cover levels.

Understory herbaceous plants are sparse or nonexistent. Natural barriers are common.

- (2) *Fire Behavior:* Due to the sparseness of understory fuels, surface fires seldom attain any size. The presence of winds is required to move fires between shrub crowns sustaining any major fire spread. However, fuel limitations and natural barriers commonly inhibit fires from affecting extremely large areas. Head fires are the most common type of fire and with strong winds can exhibit flame lengths approaching 20 feet with rapid rates of spread. Fires usually are confined to drainage bottoms, but may spread onto sagebrush flats, or pinyon-juniper mesas.

b. Grasslands:

- (1) *Description:* Both perennial and annual grasslands are present in the southern Rocky Mountains. Perennial grasslands are found along the full elevational gradient in the form of extensive grasslands at lower elevations to mountain meadows at higher elevations. Annual grasslands are comprised of cheatgrass and are smaller pockets in the western portions of the area. Perennial grasslands in the western portion are comprised of bunchgrasses and forbs, but do not form continuous fuel beds. Perennial grasses in the eastern portion are represented by sod grasses of the short grass prairie although these areas do not pose a widespread fire problem. In all areas, cured grasses can present highly flammable fuels, particularly in areas not grazed, or subject to winter livestock use.
- (2) *Fire Behavior:* In a cured stage for both annual and perennial grasses, rates of spread can be high, but fires are relatively easy to control. Cheatgrass stands pose particular concerns because they reach a cured stage very early in the summer remaining very flammable throughout the fire season.

With high temperatures, low relative humidities, and strong winds, fires in grasslands can produce flame lengths far in excess of what can be directly attacked with handtools and rates of spread that are very high. Safety is a particular concern in these situations, and escape routes and safety zones are few, and when present must have quick accessibility. Shortgrass prairie areas become flammable early in the year (as early as March), and remain in that state throughout the summer. In the absence of thunderstorm rainfall, these areas can sustain significant fire activity although the duration is very brief.

c. Sagebrush-Grass:

- (1) *Description:* This vegetative community represents a dry steppe community found between the salt desert shrub and alkali flats and pinyon juniper communities. This community occupies large areas within the Southern Rocky Mountains and can be found as a component of other vegetative communities including the pinyon-juniper, montane conifers, aspen, and subalpine lodgepole pine communities. Elevations range from 4,000 - 6,000 feet as a dominant community and up to 10,000 feet as a minor component of other communities. Annual precipitation varies from 6 - 10 inches, maximum summer temperatures can reach 80 -100 degrees. Sagebrush is by far the dominant species with associated species including rabbit brush, bitterbrush, snowberry, other sage species, various annual and perennial grasses, and forbs. Species composition increases with elevation and precipitation. Summertime is generally hot and dry with very low relative humidities. Fuel volumes will vary significantly depending upon the site, its moisture regime, and human influences. Under moist conditions, sagebrush can attain a height of 8 feet but 3 - 4 feet is the norm.

- (2) *Fire Behavior:* In areas where livestock grazing is deferred, or where a winter allotment exists, or at higher elevational zones, summer conditions include high amounts of understory grasses and forbs. This fuel continuity strongly contributes to surface fire spread. In areas where this surface fuel continuity does not exist, wind is required to move fires between individual sagebrush plants. Fuels are represented by fuel models 2 and 5 name lengths usually vary from 3 - 20 feet with rate of spread being strongly affected by terrain and wind. Heading fires are most common and nighttime humidity recovery usually reduces burning activity. Thermal belts will maintain an active fire. Spread rates are high and burned areas can reach 1 - 5,000 acres in a single burning period. With critical conditions, burned areas can go much larger in a single burning period. Seldom are wind events sustained for more than two consecutive burning periods, so the size, and duration of fires in these communities is limited.

d. Pinyon-Juniper:

- (1) *Description:* Pinyon-juniper communities cover large areas in the Southern Rocky Mountains but do not extend north of Colorado. These woodland communities occupy a transitional zone between sagebrush and oakbrush communities, or higher elevation montane conifer forests. Pinyon is the dominant species as elevations increase and juniper assumes the dominate role at lower elevations. Associated species found in this zone include sagebrush, other woody shrubs, grasses, and forbs. Generally understories are sparse with this condition escalating the older the stand is. Young stands commonly have a large understory component, usually dominated by sagebrush, and other shrubs. Distinct differences occur east and west of the continental divide.

On the west slope, pinyon-juniper stands are very dense old growth having large quantities of down and dead material. Many stands have established on mesa tops and achieved near optimal growth. In other areas, these species are encroaching into shrub grasslands in the absence of recurring fire. Understories are comprised of a dominant shrub component. On the eastern slope, pinyon-juniper stands are only found in the southern half of this area experiencing substantial thunderstorm precipitation during the summer. This situation, in combination with the understory composition of short grass prairie sod grasses and no shrub component, causes low intensity, small wildfires with only an occasional problem fire occurring.

Environmental conditions common to this zone include: elevations 5,500 - 8,500 feet, annual precipitation 10 - 14 inches, maximum summer temperatures 75 - 95 degrees.

- (2) *Fire Behavior:* Fire behavior fuel models 2 and 6 best represent this community. The sparse understory strongly controls the ability of these communities to support surface Fires. Fire burning out of another fuel type into this one can travel into it in surface fuels but seldom can sustain this for very long. The arid nature of the environment combined with the small stature of these trees makes total crown closure a rarity, thus when crown fires do occur, they are totally dependent upon strong winds to sustain their existence. High quantities of dead and downed fuels in old stands, high quantities of resin and pitch in pinyon trees, and low moisture contents of juniper trees as well as their shreddy bark make this woodland zone a very flammable situation. In the presence of strong winds, 25 - 50+ mph, independent crown fires occur that can cover large areas, 1,000 - 3,000 acres, but natural barriers and fuel changes are common and limit spread.

Even though over 50 percent of all wildfires occur in this vegetative type, few reach sizes, and durations to warrant incident management team actions. Spotting can be a problem but without wind can be easily dealt with. Seldom do more than three consecutive burning periods occur with high wind conditions, thus wildfires in these communities are relatively short-lived. Wind is the key element in these communities, fires are either a single tree, low intensity event, or a wind-driven, high intensity event covering large areas. Many national parks and monuments are located within this vegetation type. Fast moving, high intensity fires are difficult to suppress posing serious threats to communities, and other developments. Some particularly troublesome examples include the Battlement Mesa fire, and Long Mesa fire in Mesa Verde National Park.

e. Oakbrush:

- (1) Description: This vegetative type is fairly unique to this geographic area. Approximately 10 percent of all extended attack and/or team-action wildfires occur within this zone in the Southern Rocky Mountains. It is found in warm, moist environments mostly west of the continental divide. In its northern limits, it can be found as pure stands, or mixed with other tall shrubs as a mountain shrub zone. In its southern limits, it can be present in a pure community, or as a dominant understory component of aspen, or ponderosa pine stands. Oakbrush can tolerate fire extremely well and can respond with 18 - 24 inch sprouts during the same season it was burned, depending upon moisture conditions, etc. As an overstory dominant or in pure stands, it can reach heights of 10 - 12 feet but is usually in the 3 - 6 foot range. As an understory dominant, it ranges in height from 2 - 4 feet. It grows as a dense clump with an understory of total ground cover in the form of grasses, sedges, and forbs.

Other shrubs can be present and include chokecherry, serviceberry, mountain mahogany, snowberry, gooseberry, rose, greenleaf manzanita, and others. Elevation ranges from 6,500 - 8,000 feet, annual precipitation varies from 12 - 18 inches, and maximum summer temperatures can reach 75 - 90 degrees.

Fire Behavior: Fire behavior in oakbrush stands can be variable, depending upon many factors. Fire behavior fuel models for this type can include 2, 4, and 6. Live fuel moisture levels reach their lowest about the end of July. The trend in oakbrush live moisture content will follow that of cheatgrass: The lowest point will occur when, or within a few weeks of when, the cheatgrass reaches the cured stage. Fires commonly occur during July and August with intensities varying. Flame lengths frequently exceed the limits for direct attack with ground forces. Special conditions occur in this fuel type that warrant close attention. When late season frosts occur after leaves have developed, frost-killed leaves can remain on the shrub throughout the remainder of fire season. Following new leaf growth, flammability can be greatly increased, to the level of California chaparral. Fires occurring during these situations can exhibit high intensity, rapid rates of spread, and can develop into crown fires very quickly. Steep drainages where preheating can occur during the morning and early afternoon are particularly dangerous places. In 1976, within a two hour period, a benign appearing fire (Battlement Creek) quickly grew into a rapidly moving crown fire that traveled from the bottom of a drainage to the top on 50 - 70 percent slopes, and over the ridge point at nearly 100 chains/hour. Flame lengths were 20 - 40 feet, this fire resulted in three fatalities. In 1994, another benign appearing fire (South Canyon), grew from 100 to 2000 acres in a few hours, and was responsible for 14 fatalities.

Fires in these communities can be affected by winds, slopes, or by either one in absence of the other. Crowning runs can develop during consecutive burning periods and prolong suppression actions. Of particular importance is the fact that a fire can remain active in the leaf litter understory during the night, back down slopes, and then travel through the overstory back upslope during the day, in a reburn scenario. Also important is the fact that a fire may show no appearance of activity, quickly come to life during the peak of the burning period, making a significant, and threatening run. Mopup to reduce the potential of this occurring is extremely important.

f. Ponderosa Pine/Douglas-fir:

- (1) *Description:* These montane communities comprise a significantly important portion of the Southern Rocky Mountain area. These communities are found between the pinyon-juniper woodlands, the subalpine zone west of the continental divide, between the short grass prairie, and the subalpine zone east of the continental divide. Within this zone approximately 60 percent of all extended attack and/or team-action wildfires occur in the Southern Rocky Mountains. These communities occur between 6,000 - 8,500 feet and are comprised of ponderosa pine, and Douglas-fir trees. Understories vary significantly with drier sites having grass-needle understories to those having dense shrub understories in heavily shaded conditions. Slopes range from very steep to gentle. Annual precipitation ranges from 12 - 20 inches, and maximum summer temperatures are found in the range of 70 – 90 degrees. Fuel complexes in these communities have been markedly altered in some areas through fire suppression, grazing, timber harvesting, insect, and disease occurrence.

Open stands having low accumulations of down and dead woody materials have been changed to areas characterized by numerous dead overstory trees, shade tolerant regeneration abundant in the understory, heavy accumulations of surface fuels, high vertical, and horizontal fuel continuity. Mountain pine beetle, and spruce bud worm infestations on the east slope have left entire hillsides with standing dead trees representing significant snag hazards.

- (2) *Fire Behavior:* Fire behavior in these communities ranges from low intensity surface fires in needle-grass fuels to all types of crown fires. The specific fire type that will occur is dependent on the fuel availability, fuel quantities, environmental conditions, topographical conditions, weather conditions, and present stand structure. All types of fires, (heading, backing, flanking, and crown) can occur with active burning possible throughout nighttime periods, and sustained by thermal belts. Nighttime inversions develop frequently in valleys but fires can sustain activity above the inversion on slopes. Of special concern is the speed with which a fire can change from a benign surface fire to a fastmoving, high intensity crown fire. Safety considerations regarding this potential are paramount. Fire behavior predictions are an extremely valuable part of incident action plan development, and implementation.

g. Lodgepole Pine:

- (1) *Description:* Lodgepole pine forests comprise the second largest forest type in the Southern Rocky Mountain area. Team-action wildfires in this vegetative type represent about 25 percent of the total. Elevation of this community ranges from 8,000 and 12,000 feet. Annual precipitation is primarily received in the form of snow and amounts to 12 - 18 inches. Maximum summer temperatures range from 65 - 80 degrees.

Understory fuels are sparse or nearly absent in this vegetative type. Stands are even-aged unless infected by disease which has caused early overstory mortality opening canopies for regeneration. Fuel complexes have been affected by insect and disease infestations. Mountain pine beetles have infested widespread areas, especially in northeastern Utah. Dwarf mistletoe infection represents the most significant disease in lodgepole pine and infects over 50 percent of all stands. This disease has caused enough mortality in some stands that predictive fuel models have changed from 8 to model 10 and downed fuel loadings have increased from 5 - 10 tons/acre to as high as 75 - 100 tons/acre. Large amounts of standing dead trees are present posing significant snag hazards to firefighters.

- (2) *Fire Behavior:* Wildfires can be very intense and fast moving in these communities. Some important points to be aware of are that the lowest live fuel moisture contents of the year occur immediately prior to bud break, some of the largest fires have occurred at this time (early June). In stands unaffected by insects, or diseases, surface fuels seldom support much fire activity. Overall stand flammability varies with age as young and very old stand; are the most flammable, and immature to mature stands are much less flammable. Stands affected by insects, diseases, and fire suppression can have greatly increased fuel loads, and exhibit all types of crown fires, especially supported by the surface fires. Reburning over previously burned surface areas is a possibility and residue burnout of downed fuels prolongs suppression activities. Under conditions of high winds, fires can cover large areas in short time periods. Since lodgepole pine is a fire dependent species, its presence and appearance is an indication of past fire activity and fire behavior.

h. Spruce-Fir Forests:

- (1) *Description:* This fuel type occupies a relatively large area at higher elevations within the Southern Rocky Mountains. Team action fires occur here about 5 percent of the total time and are difficult and expensive to suppress. These high elevation communities are comprised of Engelmann spruce and subalpine fir, with some lodgepole pine present. Surface fuels can be minimal in open grown stands, or very heavy, predominantly large down tree stems, in closed canopy stands. Tree limbs of both species of trees usually are present all the way to the ground, posing good vertical fuel continuity. Elevations of these communities are 9,000 - 12,500 feet, annual precipitation is 15 - 25 inches, and maximum temperatures range from 60 - 70 degrees.

The Flattops Wilderness Area is unique in that it suffered a spruce beetle epidemic about 40 years ago resulting in extremely high tree mortality. The relatively high elevation of this area (10,000+ feet) has inhibited tree decomposition, the present forest is one of regeneration coupled with large quantities of standing dead trees in the form of large snags, and heavy surface fuel loadings. Fires in this area are extremely difficult to control, pose logistical problems, necessitate wilderness camps, and pose extreme safety hazards to firefighters who are on the line and in camps.

- (2) *Fire Behavior:* These stands often burn in patchy, spotty patterns best described as hundreds of spot fires. Regular line construction and burnout efforts are ineffective on fires in this type. Spread is by torching of individual trees or groups of trees with spotting into more individual trees downwind. Retardant is seldom effective. These fires have the potential to wear crews out especially in low relative humidity situations with the constant torching and spotting into new fuels.

Heavy down fuels, deep duff layers, and dense stands can make fire suppression a very laborious process. The key to suppression in this type is having crews limb up all trees with fire under them, to remove the ladder fuels, stop the torching, and spotting into new fuels. Once spread is stopped, water from pumps, engines, foldatanks, and bladder bags can be used to speed up the mopup in deep duff and heavy downed materials under the trees. In heavy bug-killed areas, slash fuel models (12 - 13) are appropriate for fire behavior predictions.

II. SUPPRESSION STRATEGIES AND TACTICS

A. Strategy.

Since both the Great Basin and Southern Mountain areas contain a full spectrum of resource values at risk, fuel types, and terrain features, appropriate strategies utilized during suppression activities will vary depending upon the specific set of conditions for a particular incident. Control-contain-confine strategies will be common between all agencies with objectives defining greater effort in minimizing burned areas as values at risk increase. Strategy will be set by the Escaped Fire Situation Analysis (EFSA), Delegation of Authority, or other direction from the agency administrator. Costs and environmental concerns will have the major effect on strategy in the Great Basin and Southern Rocky Mountains.

1. Direct Attack.

Generally speaking, on most fires within the Great Basin and Southern Rocky Mountains lower elevation fire communities (pinyon-juniper and northern desert shrub-sagebrush), direct attack with handtools and engines can be effective. Direct attack is also effective for higher elevational fuel types depending on the fire intensity. Normally the flame length and spread rates will allow close-in work with equipment. Water and retardant can effectively stop the fire spread. If rekindling occurs, it will happen over a short period of time due to the light fuels. Most failures come from running out of water prior to completing control line. Aerial retardant is

effective in direct attack for establishing line and also for tying engine lines together. Foam units and single engine airtankers dropping foam are becoming more common and are very effective in these light fuels.

The direct attack method is limited by the following:

- Ability to work close-in to the fire (fire intensity), size of perimeter, and number of engines available.
- Availability of water.
- Terrain (maneuverability).

2. Indirect Attack.

In lighter fuels, indirect attack and burning out are a good approach in areas where resource values are low, and fire size isn't a major concern. Indirect attack also becomes an option when direct attack is limited as mentioned earlier.

Indirect attack is also used in higher elevation fuel types to stop the spread of crown fires.

When using an indirect attack, several factors must be considered:

- Natural barriers.
- Roads.
- Burned acreage.
- Timing - Can burnout be completed prior to fire spread reaching predetermined line?
- Availability of resources for firing and holding.
- Methods available to prepare burnout line. Methods of preparing burnout line that have proven effective include:
 - Wet line with immediate burnout.
 - Engine applied retardant or foam line.
 - Airtanker applied retardant line.

NOTE: Indirect lines have to be fired out immediately. CARRY YOUR FIRE WITH YOU! Time and availability determines ignition device used.

Time is critical. Ground and aerial based ignition devices can be highly effective. Terratorches mounted on four wheel drive vehicles offer high utility while aerial devices including the helitorch and plastic sphere dispenser both provide a rapid firing method.

Ground firing by hand is much slower but also effective.

3. Parallel Attack.

This type of attack is used on medium to large sized fires at higher elevations. Intensity of these fires frequently precludes direct attack so establishment of sound anchor points and well timed burnouts makes this method successful.

Again, the full spectrum of tactics is available and will be called into play in this geographic area. As resource values at risk increase, tactics will implement a more aggressive and productive capability of suppression resources.

Common tactical considerations include:

- Night operations - can be highly effective.
- Helicopter rappelling becoming increasingly important.
- Use of natural barriers/fireline location.
- Chemical retardant use and limitations on use.
- Burnout, aerial and ground ignition.
- Coyote tactics.
- Minimum Impact Suppression Tactics (MIST) - should be standard procedure on all wildfires but will be mandatory in all wilderness areas.
- Minimum impact rehabilitation techniques.
- Mopup standards.
- Helispot location and rehabilitation.
- Safety concerns/snag problem areas/evacuation needs.

B. Suppression Resources.

Engines and hand crews are the primary tools in the Great Basin and Southern Rocky Mountains. Most engines are four wheel drive and range in size from 100 to 1,000 gallons in capacity. Foam and retardant capability is becoming common on most engines.

Hand crews are the most common resource utilized on extended attack and team-action wildfires. Use may be limited in some areas due to terrain but hand crews can be extremely effective where terrain limits other techniques. Hand crews require substantial logistical support.

Bulldozer use has decreased in recent years due to environmental considerations but still remains a viable tool when warranted. Shallow soils and arid environments are difficult to rehabilitate.

Helicopters are effective for reconnaissance, personnel movement, initial attack support, supply transport, water, or chemical delivery. Airtanker use in the Great Basin is moderate, airtanker use in the Southern Rocky Mountains is greater although the primary use in both areas is for initial attack. There are numerous airtanker bases throughout this area with the capability for operation of portable refill bases to support large fire suppression activities as needed. In wilderness areas, helicopters will be critically important and large air operations will be common.

III. SPECIAL CONSIDERATIONS OF THE GREAT BASIN AND SOUTHERN ROCKY MOUNTAINS

A. Snakes, Scorpions, and Insects. Rattlesnakes and scorpions can be quite common throughout this area. Special safety instructions should be provided to ensure personnel safety. Yellowjackets, hornets, wasps, ticks, and spiders (tarantulas and black widows) can be encountered also.

B. Access. Generally, four wheel drive vehicles can move over terrain. Some rock outcroppings, steep sided gullies, cliffs, and underground arroyos pose special hazards at night. Loose soil types and rocks can high center vehicles quickly.

Foot travel is difficult. Sprained and broken ankles are possible. Tall sage is difficult to move through. Rapid rates of spread and sudden wind changes create needs for crew awareness, safety zones, and escape routes.

- C. Fuel Models. As typical of fuel models described in "History of Fatalities and Near Misses," light flashy fuels have caused more fatalities than any other fuel models. Avoid complacency, all fuel models support fire, and fire is dangerous.
- D. Aviation. High elevations and hot temperatures produce high density altitudes. Most fire activity is at, or above a density altitude of 9,000 feet. Helicopter and fixed-wing performance is reduced. Military training routes and special use airspace (especially west desert Utah, southern Idaho, and all of Nevada). Lack of water sources requires heavy water tender support if any major tactical water show using aircraft is planned. Retardant is ineffective in wind-driven fires.
- E. Water. Due to high temperatures and direct exposure to sun, water consumption will be abnormally high. Up to two gallons of water per person, per operational period, is often necessary. This requires special efforts to get crews to carry enough water, it is a good idea to also make extra water available on the line. Dehydration is a serious problem if adequate water is not provided. Potable water must be obtained from a safe source due to giardia in many streams.
- F. Vehicles. Because of the access and the fuel type, build-up of vegetation on the undercarriage of vehicles often occurs. Undercarriage fires are not uncommon, with fire being spread over a considerable distance before the driver is aware of a problem. Catalytic converters also present a potential ignition device whenever the vehicle is traveling across country.
- G. Volunteers. Due to the remoteness of areas within the Great Basin and Southern Rocky Mountains, local ranchers and other parties are often on the fire when fire suppression personnel arrive. This can present a serious safety concern. Volunteers should be released from the fire or provided the necessary personal protective equipment and close supervision, as quickly as possible.
- H. Adverse Weather. Rapid changes of temperature from hot to very cold, often with moisture (sometimes snow) can pose a serious hypothermia threat to personnel. Planning should include plastic sheeting to keep crews and equipment dry in the case of rain or snow, fuel for warming fires, and a place where wet, cold firefighters can be taken to dry out and warm up.

When utilizing camps, they should be equipped early on with plenty of plastic sheeting and rations in case bad weather should prevent resupply by air, which happens frequently.

Of particular importance are chinook winds. These winds occur when high pressure systems set up west of the continental divide in the Southern Rocky Mountains. In this situation, winds push up against the mountain range, crest it, and then travel eastward downslope. As they travel downslope, they pick up speed, frequently achieve speeds of 80 -100 mph at the base of the foothills. These winds can drive any fire downslope regardless of the diurnal, upslope wind patterns, and slope interactions (Ouzel Fire, Old Stage Road Fire).

- I. Medical Facilities. Medical facilities are few and far between, evacuations for serious injuries will generally be by air.
- J. Snags. Insect and disease caused tree mortality has created significant snag areas throughout the timbered areas of this geographic area. Fire suppression personnel should be aware of snag areas and take appropriate actions to minimize exposure to firefighters. Snag-related injuries have been increasing during recent years.
- K. Terrain Features. Unique terrain features such as the major river breaks (Salmon, and Snake) can pose specific problems. In these areas, steep slopes and dry fine fuels produce very fast moving fires. Special safety considerations are necessary here in that tactics may have to be modified in regard to crew placement, camp location, and crew movement. Use of coyote tactics can be common also. Numerous instances of shelter deployment have occurred in these river break areas (Ship Island, Butte, and Eagle Bar Fires).

SOUTHWEST

I. FACTORS INFLUENCING FIRE BEHAVIOR IN THE SOUTHWEST

A. Topography

Topography is the greatest single factor influencing fuel types in the Southwest. Elevations range from near 1,000 to over 13,000 feet. Like the Peak fire, steep mountain ranges in southern Arizona and New Mexico have many fires which burn from bottom to top and go through many fuel types.

In addition, aspect plays a bigger role in fuel types and in fire behavior in the Southwest than any other area in the United States. Fuel types frequently change on ridge tops and in drainage bottoms.

At lower elevations, south and west slopes are frequently grass or desert shrub while north and east facing slopes can be pinyon-juniper or pinyon-juniper mixed with various types of brush. Canyons may have a mixture of deciduous trees, conifers and brush in the bottoms.

Mid elevations may have pinyon-juniper on south and west slopes with ponderosa pine and oak on north and east slopes. Canyons may be a mixture of ponderosa pine, pinyon-juniper, oak and brush.

Upper elevations often have ponderosa pine and oak on south and west facing slopes and mixed conifer and aspen on north and east slopes. Canyons may have ponderosa pine on drier sites with mixed conifer across the drainage.

Fire behavior can be drastically different from one side of a Ridge/drainage to another due to the differences in fuel types and moisture levels.

Land form is also an important factor as fires can move long distances without wind. Slope driven fires are quite common especially in lighter fuel types.

The Mogollon Rim is the most dominant geological/topographic feature in the Southwest Region. It extends from Ashfork, Arizona to Luna, New Mexico. It is a continuous uplift which rises 2,000-4,000 feet above the lower elevations.

The base of the rim is 6,000-7,000 feet while the top ranges from 8,000-10,500 feet. Fuel types range from pinyon-juniper-oak and brush to mixed conifer and aspen.

The land north of the Mogollon Rim is referred to as the "Colorado Plateau." The Colorado Plateau loses elevation from the Mogollon Rim as it spreads to the north. Fuel types go from spruce-fir to ponderosa pine to pinyon-juniper to grasslands. Land forms are generally gentle sloping with steep drainages. However, there are also large volcanic derived mountains which rise above the existing plateau. These have their own fuel types based upon elevation and aspect.

The southern part of both Arizona and New Mexico includes steep rocky terrain. Southern Arizona has unique "sky islands" which include all of the Coronado National Forest. These mountain ranges all begin with desert fuels at the base and end with mixed conifer, and/or spruce-fir at elevations over 9,000 feet.

Southern New Mexico is similar except the mountain ranges are generally much larger in size.

Fire behavior predictions using any computer modeling are difficult because of the ever changing topography and fuel types. Again - it's a good idea to have a local fire behavior specialist.

B. Weather

1. Precipitation:

Weather is another obvious factor influencing fire behavior, with topography or elevation being tied to precipitation kinds and amounts. Elevations of 7,000 feet and above generally receive in excess of 100 inches of snow annually. Elevations above 8,000 feet generally have a snowpack of two feet. Snowpack of six to seven feet may be found above 9,000 feet. Total annual precipitation ranges from 4 inches in the lower deserts to 20 inches at 7,000 feet to 35 inches at 11,000 feet.

2. Winds

Spring begins in late March at the lower elevations and in April at the higher elevations. Weather is generally dry and windy.

Daily winds above the Mogollon Rim can average a steady 20-30 mph for many days at a time reducing snow pack and exposing fuels to sun and wind. High elevations in the southern part of both Arizona and New Mexico receive similar winds.

Winds can reach 50-70 mph as spring storms move across from the west. Although some moisture is received, the effects are short-lived due to continued winds. By the end of May most snow has melted except at elevations above 10,000 feet. Fire during these periods can move significant distances in short time frames especially in ponderosa pine above the Mogollon Rim.

May and June are the two driest months and those in which most large fires occur. Winds continue through May but generally subside in June. Temperatures range from 110 degrees or more with 5% humidity in the desert to 90 degrees and 10 % humidity at 7,000 feet. Fire behavior is obviously extreme during these conditions which makes suppression efforts difficult.

In late June or early July the Bermuda High sets up off Florida and affects much of the nation's weather. This high creates a flow of moisture aloft from the Gulf of Mexico and into the Southwest. This moisture mixed with the daily high temperatures creates the summer thunderstorm and monsoon season. The Southwest has the highest incidence of lightning caused fires in the United States.

The lightning season starts out as dry lightning storms in late June in southern New Mexico and Arizona and continues northwest across the Southwest area during the next two to three weeks. The storms become wetter as the Bermuda High sets up. Showers are scattered then become more widespread.

This rainy season continues through July and August. Daily temperatures are still over 100 degrees in the desert and near 90 degrees above 7,000 feet. Fires in low elevations are a problem because of lack of moisture in fuels even though RH is higher.

September and October can be dry and windy. During this time there is an increase in human-caused fires due to hunters. Night time temperatures and RH keep these fires to one or two burning periods.

C. Fuel Types

The Southwest has twelve fuel types. One fire can involve many of these types. The six problem fuel types for firefighters are:

1. Grass Fuels

Grass fuels are widespread in the Southwest and consist of annual grasses in the lower elevations and perennial grasses mainly in the higher, more humid, elevations. Although grasses are mixed throughout all the fuel types, desert fuels are part of this fuel type and rates of spread are significant due to typically low RH.

It takes surprisingly little grass cover for ignition or fire spread. These fuels are very flashy and combined with a wind (especially from a thunderstorm) can result in a fast moving erratic spread.

Some grass types like sacaton and bear grass produce high intensity fires. These fuels react quickly to changes in RH. Spread is obviously achieved by wind and also by slope. Fire can run up slopes then stop. There is little spotting.

Sotols, a succulent found within the desert plant community, are a problem and spread desert fires quickly. When sotol are on a slope and the roots burn through, the plant breaks loose and rolls downslope.

These fuels react quickly to changes in RH. Early in the afternoon fire can move rapidly, then clouds buildup, humidity increases, and burnouts cannot be accomplished. Because of this a fire can look extremely placid but just a couple of hours later as temperatures rise and RH changes the fire may take on a significantly different behavior.

2. Shrub/Brush

The fuels include various desert and brush species dominated by manzanita, several species of oak and mountain mahogany. Grasses are important for ignition and spread in this fuel type. However, absence of grass has little effect on steep slopes or during windy conditions.

Fires are intense and can have rapid rates of spread. Percent of dead material plays a large role in fire spread.

Green fuel moisture also plays a major role in spread. Local fire management officers should track the moisture content and give you criteria on critical thresholds by species.

Live fuel moisture is a very good indicator of burning conditions in the chaparral fuels. Where fuel moisture reaches 70 percent or less, extreme burning conditions can be expected.

The location of this fuel in relation to any commercial timber land is important. Lack of control of a fire in this type can result in a large fire in ponderosa pine.

Spotting is not much of a problem but fire intensity creates a rapid spread. Fires typically slow or even stop at sharp ridge tops.

3. Pinyon-Juniper

This type generally falls between the ponderosa pine and shrub/brush types. However transition areas can have a mixture of brush species and/or ponderosa pine.

In pure stands, fire is not much of a problem as there is typically little ground fuel due to grazing and soil conditions. In areas where stands are dense, fires can spread with a good strong wind. Spotting in Utah or one-seed juniper stands is common but fire spread is slow.

Stands with an understory of brush, grass, or down fuels can burn intensively and move rapidly. Typically a wind is needed to spread the fire unless the fire is on a steep slope.

Again the location in relation to the commercial timber land is important as fire can spread into the pine stands easily.

4. Ponderosa Pine

Ponderosa pine is found at elevations ranging from 6,000 to 9,000 feet and occurs in all geographic areas.

Most large fires needing incident management teams occur in this fuel type. Most of the ponderosa pine stands have been commercially harvested sometime within the last century. Fire behavior depends on previous logging activity, resultant residual slash, stand density, quantity of stories, and ground fuels including associated shrub species.

Fire spread can be extremely fast especially with wind. Crown fires are common but generally are dependent on ground or ladder fuels to sustain.

Spotting is a large contribution to spread and is very common up to 1/4 to 1/2 mile ahead of the fire.

As a guide, whenever 1000 hour fuels (dead fuel over 3 inches in diameter) reach 13% or lower, we can expect critical burning conditions in this fuel type.

Across an evenly flat plateau, fires can become very large if wind driven and spotting is active. Ponderosa pine is a valuable resource as it is a highly valued commercial timber species and a significant portion of recreation activity occurs within this type.

5. Mixed Conifer

This type includes various mixtures of ponderosa pine, southwestern white pine, Douglas-fir, white fir, and Engelmann and blue spruce. Generally these fuel types occur above 8,000 feet. A large percentage of mixed conifer occurs on steep slopes.

Some of these stands have been logged but others have not. Fuel loading is significant at 70 to 150 tons per acre. Access is limited due to steep slopes and lack of roads. Fires are intense and spotting can easily occur up to 1/2 mile.

Although historically significant fires have not occurred here (in relation to ponderosa pine), as stands are being logged and sites are dried out more fires will occur. Also, recreation use of the mixed conifer type is increasing which will increase human-caused fires.

Many large fires can occur because of fires escaping from the ponderosa pine zone.

Where logged, most stands are very dense with total canopy closure. Mixed conifer fires are difficult to control due to lack of good topographic features.

6. Spruce-fir

This fuel type, in the Southwest, occurs only in locations above 9,500 feet. Fires are rare but mentioned here because they are extremely difficult to control. They typically are at the top of a mountain range and therefore above all the other fuels.

Access is extremely limited. Fuel loading is heavy and spotting is severe. On large fires, because of the steep topography, fuel loading and access problems, control lines will generally be outside this fuel type.

II. STRATEGY AND TACTICS

- A. Direct attack as a strategy works well in the Southwest especially when fires are small. If a fire is large, a number of items need to be considered before deciding on strategy; topography, fire behavior and intensity, rate of spread, availability of needed resources, logistics in moving and supplying firefighters and of course, probability of success.
- B. Indirect attack is also used, especially in lower elevation fuel types. Acreage is often sacrificed for lower suppression costs and higher probabilities of success. Direct attack on a fast moving desert or brush fire is seldom successful. Using natural barriers and roads when burning out is very common below the Mogollon Rim. Dozer use below the Rim is limited for environmental reasons. Dozer tracks stay forever in the desert. Disturbing the soil creates erosion problems during intense thunderstorm activities.
- C. Parallel attack with burnout is also used with success on wind driven ponderosa pine fires. Nanking until wind quits then cutting off the head is frequently used.

On most large fires a combination of direct, indirect, and parallel may be used. Again much is dependent on line officer direction, EFSA, available resources and team philosophy.

Safety as the first standard fire order is above all else. No strategy or tactics should be considered if it sacrifices safety. Safety should be included in all planning.

D. Developing Tactics

First, topographic features are of great importance in determining line location. Remember, that fuel type changes at ridge tops and drainage bottoms. Because of this, especially below the Mogollon Rim, these fires typically have a tendency to run to ridges and quit or slow down. This is extremely important to remember in indirect attack situation. Midslope lines seldom work in the Southwest.

Natural barriers can be used to a great extent and can save many hours/days of line building. Natural barriers have been used as control lines, burnouts accomplished from the air, and the next day a small task group assigned to pick up slop-overs.

Burnouts are a must in the Southwest. A line not burned out is almost worthless. In parallel and indirect attack bring fire with you even without lines being tied in. Unless indirect line is quite distant, the line can easily be out-flanked by a fast moving fire. Don't wait for "perfect" burning conditions. However, burning in the middle of the afternoon can be disastrous. Burnouts are very successful at night as long as RH stays low (although not to where spotting occurs). But again, if that's the best condition you have, then do it! Early morning burnouts before the heat of the day are not very successful. All night operations are generally successful and should be utilized.

Burnouts can be accomplished by hand (drip torch, very pistol, fusee or pen flare), Terra-torch or similar home-built equipment, and by air with ping-pong machine or flying drip torch.

Length of line constructed is much more important than the width or quality of line. When burning out, especially with crews on the scene, holding is fairly easy. Fires typically move too fast for any slow line construction techniques.

Because of lack of ground fuels some chaparral brush country is difficult to ignite especially from the air. If unsuccessful, burning out may need to be done under windier, lower RH or higher temperature conditions.

Burning periods in the Southwest occur between 10 a.m. and 4 p.m. Depending on wind, temperature, RH and live fuel moistures, fires can burn actively 24 hours a day. Shift changes can and should be adjusted to insure crew movement is not taking place during critical burning periods.

Since these conditions prevail, especially in the desert country, many years ago "coyote" tactics were developed.

The coyote tactics consist of a progressive line construction technique involving self-sufficient crews who build fireline until the end of an operational period, remain overnight at/near that point, and then begin again on the next operational period.

Crews should be properly equipped and be prepared to spend several operational periods on the line with minimal support from the incident base.

Camps are standard and should be used. They can be supplied by air and crews moved by air to camps. Crew movement should be kept to a minimum to reduce exposure to air and road travel.

Mopup is critical in ponderosa pine and mixed conifer stands. Desert fires require little, but cold trailing is effective. Where cold trailing is used it must be watched or patrolled.

Immediate rehabilitation of control lines is necessary. Most moisture occurs as intensive thundershowers and soil movement is rapid and immediate. Unless otherwise directed, most Southwest type I and II crews place water bars as firelines are constructed.

Archeological sites, both prehistoric and historic, are everywhere across the Southwest. Special precautions or changes in tactics may be needed to protect them.

Threatened and endangered species include birds (Mexican spotted owl, Goshawk), animals (Mt. Graham squirrel), fish (Apache Trout, Gila Trout, spinedace, loach minnow), and plants (Arizona willow, Mogollon paintbrush, various cactus). Almost any drainage with permanent water has some threatened or endangered species associated with it. Make sure you get this information and receive direction on guidelines and protection.

With few exceptions (National Park Service) all lands within the Southwest are grazed by either cattle or sheep. Tactics using overgrazed areas as anchor points or locations for control are successful.

Be aware of livestock location when locating camps and when burning out. Fence locations are also important to know. If a fence is cut, notify local authorities.

Make agreements with local land owners, agency representatives, and/or permittees before using stock water for firefighting operations.

Location and amount of slash is important in determining tactics. Protection of reforestation areas will be needed.

III. Suppression resources within the Southwest and their effectiveness.

A. Engines

Numbers of engines are limited. **All** units have a few which range from Model 20s to Model 70s, 71s and 46s. There are few four-wheel drive models. You will find that most units want their engines returned to the home unit for initial attack. You will not receive a large number of engines from within region if requested. Then again you may not need many. Time should be allowed to receive engines from other geographic areas.

Engines are very effective on large fires for holding line and mopup situations.

B. Dozers

These are even more limited. Most units have one or two small (JD 3501450) dozers. However, again, pressure will be applied to return these to home units for initial attack. Dozers and log skidders are extremely useful in ponderosa pine and mixed conifer fuel types.

Dozers can be used in lower elevations but are restricted by rock, steep slopes, and environmental concerns.

C. Helicopters

Helicopters are effective for crew movement, spike camp and line supply, bucket work, and aerial ignition for burnouts.

Bucket work is restricted by lack of water. Effectiveness is affected by turnaround time.

The biggest restriction in the Southwest when utilizing helicopters is density altitude, with high temperatures and high elevations, payloads are extremely limited. When ordering helicopters be sure and describe the type of performance you require based on the altitudes you are working in or you will receive something which can't be used.

D. Airtankers

There are 11 airtankers assigned to the Southwest. As with helicopters, turnaround times are important in -their effectiveness.

They can be used in light fuels (desert) as initial attack without crew support and are effective.

In ponderosa pine and mixed conifer they are also effective if wind conditions are low. Airtankers are not useful in stopping crown fire at their heads but are typically used in flanking action. They are effective in reducing behavior for hand crew action and holding a fire until crews can arrive.

Airtanker drops without retardant (water only) have been used in cases where aesthetics are important.

Late afternoon airtanker or helicopter work can be successful in suppressing fires without ground support in light fuels.

E. Type 1 Crews

There are 18 Type 1 crews within the Southwest area. Depending upon the regional fire situation crews will arrive from a couple of hours to 12 hours after ordering.

F. Type 2 Crews

Through an agreement with SWIFF (Southwest Indian Fire Fighters) 78 crews are available for dispatch. Typically, they can be on the scene a few hours to 12 to 18 hours after ordering. Most are extremely good and can be used on hot line. Others cannot. You must judge.

G. Saws/Saw Teams

Saws and saw teams should be ordered with Type 2 crews. Few Type 2 crews include individuals who are qualified. Saws are a must for brush as well as for timberland.

Regular crews will carry their own saws but since you probably will be in the Southwest during a multiple fire situation most employees will have already been assigned to other fires.

Contract sawyers are limited.

IV. SPECIAL CONSIDERATIONS

A. Safety

Southwestern fires can be suffocatingly hot, have steep rocky slopes, cactus, snakes, tarantulas and scorpions. Everything either bites, stings, pokes or scratches.

All of these can result in medical emergencies and medivacs. The lack of roads and long distances to medical facilities requires special attention to medivac plans. We try to have line qualified EMTs on each division.

Temperatures in the desert frequently are above 110 degrees. Dehydration is a problem. Each crew member needs a minimum of two gallons of water daily.

Differences in daytime and nighttime temperatures can be dramatic and can cause various medical afflictions. Working all day in heat and moving to higher elevations where it is cooler can affect a person's health. Getting wet with a brief afternoon shower can also be a problem. Nighttime temperatures in the desert can be very cool.

Situations can occur where you can have cases of heat stroke and hypothermia during the same day and on the same piece of line.

Open water should not be used for drinking as giardia is common in all Southwestern streams and lakes. Plan on supplying all potable water.

Density altitude was discussed earlier. It is important not just in crew and cargo movement but also in medivac helicopters. Be sure your selected medivac helicopter has sufficient payload.

Air attack is the eyes and ears of ground forces. It is extremely helpful in monitoring quickly changing fire behavior situations. It is good to keep an aircraft over the fire from daylight to dark if possible. However, do not depend on them for total information. They are just another "tool" and do not replace on-the-ground lookouts. If you depend upon aerial observations alone and the aircraft must return to base due to mechanical problems or sickness then you would be out of luck.

B. Functional Considerations

1. Fire Behavior

Fire activity may not decrease at night due to lack of RH recovery.

Fire behavior during daytime hours, especially at lower elevations, is extreme and intense. Expect very large fires.

2. Sotols

A Sotol is a yucca which, when burned, develops the shape of a basketball. It will roll downslope spreading fire. "Rock the Sotols." They are dangerous to firefighters. Mid-slope lines are ineffective.

3. Logistics

Roads are few and those that exist are bad. Reduce exposure to road travel. Use camps but also keep helicopter flights at a minimum.

Overall travel for suppression and support activities is slow. Understand this in developing strategy and tactics.

4. Urban Interface

Communities are being built in wildland fuels all over in the West. Access in and out of these communities is almost always limited. In addition to these communities, the Southwest has hundreds, if not thousands, of isolated homes, summer cabins, mining cabins, ranch houses and other structures scattered about.

Coordination with local agencies, homeowner groups, and others knowing roads and structure locations is extremely important.

NORTHEAST

I. THE NORTHEAST AREA

- A. Forest Types - There are 11 major forest types in the area. The most common is oak-hickory (Fire Behavior Fuel Models 8 and 9) which is found in all 20 states. This discussion will include spruce/fir (Fire Behavior Fuel Models 4 and 10) of New England and Northern Minnesota, the pine barrens of New Jersey, (Fire Behavior Fuel Model 4) the jack pine/red pine (Fire Behavior Fuel Model 6) areas of the Lake States, and the peat/muck fuels found in the northeast and elsewhere in the US. Some of the others which play a major role in a normal fire season are common to the Southeast area and will be discussed there.
- B. Topography - The Northeast Area is the same as the USFS's Eastern Region. It is a 20 state rectangle with the "4M" comers – Minnesota to Maine to Maryland to Missouri. It is relatively flat with elevations ranging from sea level to 6,288 feet above sea level. While local topography may cause some concern, the overall impact is not significant except in the mountainous areas in the New England and Mid-Atlantic States.
- C. Weather - The fire weather season in the Northeast usually lasts from March through November. It is characterized by a spring fire season that starts in the southern part of the area and moves northward. By mid-June the major period has passed and there will usually be a lull until early or mid-September when the fall fire season begins. How soon this area gets frost and the maturing of the fine fuels and hardwood leaves will determine when the major fire activity begins. The season moves slowly southward and will usually end in mid-November in most of the area. Although extreme fire behavior and severe fires are experienced in the fall, the chances are lessened by the shorter, cooler days, nightly frost, and limited drying periods. Unless it has been an unusually dry summer and fall the only serious problems will occur with the weather system known as "Indian summer." This is a period of two to five days when a stagnant, dry high pressure system is in the area. Temperatures in the 80's are not uncommon; relative humidities will drop to the middle or low teens, and the winds will usually blow from a southerly direction. Speeds may vary from 3 to 13 miles per hour with gusts up to 18 - 25 being common.

Some other characteristics of this pattern are limited relative humidity recovery at night; minor nighttime temperature changes; continuous winds, even after dark; and very hazy conditions which reduce visibility to two miles or less.

Four of the six synoptic weather types, all associated with high pressure systems and periods of critical forest fire weather in the United States, are found in the Northeast Area. They are:

1. *Pacific High*

- a. Loses moisture crossing the Rocky Mountains; arrives in the Northeast as a dry continental air mass. Usually about three days from the time it crosses into the Continental U.S. before it arrives.
- b. More numerous than any other type of system.
- c. Often tracks southeast across the bottom of the region. Can give the Southeast more problems than the Northeast.
- d. If the preceding cold front is *dry*, high fire danger occurs in the postfrontal area.
- e. The western or northwestern side is usually the most dangerous side of the system.

2. *Northwestern Canadian High*

- a. Is dry to begin with because it originates over land.
- b. All sides can be dangerous, but the north and northwest sides are the most critical.

3. *Hudson Bay High*

- a. Tends to stagnate in the Hudson Bay area.
- b. Moves south into the United States so it passes right over the Lake States on its way.
- c. The greatest danger usually occurs on the Northwest side of the high.
- d. The longer the system is with you, the more the visibility deteriorates. Can get as low as two miles or less.
- e. Most frequent in the spring and fall.

- f. This is the system that will tear you apart before you know what has happened. It begins as a cool Canadian High which forms over Hudson Bay ice and moves south. It picks up very little moisture over Canada and warms through subsidence. The humidities will drop (10 percent or less in extreme cases), temperatures go up and winds become gusty. Nighttime temperatures may vary as much as 40 degrees. Humidity might not recover. Tendency to stagnate for days. Visibility goes to pieces. At height may be one mile. Is a haze. When it begins to move, winds will shift from E to S-SW-W. Tendency to fishtail. Sign that system is moving! Lake States' forecasters are experienced with this weather pattern and will advise you of it.

4. *Bermuda High*

- a. Long lasting and stagnant type of system.
- b. Frequent in spring, early summer and fall.
- c. Quite often extends into Texas to block the flow of moisture from the Gulf of Mexico. Type of system said to cause a lot of the drought type conditions that existed in the NE in the spring and early summer of 1988.
- d. Low humidities and high temperatures common with this type.
- e. The worst winds for fires occur when low pressure troughs pass by a stagnant Bermuda High on its north side.

Add the Alberta Low to this list as a catalyst, especially when it follows on the heels of the one of the highs just listed. This type of system can prompt a dry lightning situation along with high winds. It was this combination which moved across a very narrow band of northern Minnesota, Wisconsin, and Upper Michigan on May 6, 1986, with surface winds of 50 - 60 mph. During its passage a USFS prescribed burn escaped mopup for 1,000 acres, a major forest fire of 8,000 acres threatened an air force base on Michigan's Upper Peninsula, and 80 power line fires were started in a three county area of northern Wisconsin.

In addition to the systems mentioned, the Atlantic Coast can have occasional high fire danger associated with tropical storms when the windy area reaches beyond the wind and cloud shield.

D. Strategy.

A full control strategy using direct or flanking attack is the most common. These strategies are driven by two major factors:

1. Federal land ownership is a very minor part of the total landscape and, in some instances may even be a minor part of the holdings within the boundary of the property. At the same time the number of qualified fire personnel and the fire equipment on the federal properties is limited to non-existent. Several of the states protect the federal property under contract to the agency.
2. Time is the second major factor. Almost all project fires will complete their run during the first day of the burn. They may burn through the night, but by morning of the second day they will have ended because of a change in fuel type, successful control by the local agency, or a combination of the two. The exceptions may be found in the national parks, such as Voyagers and Isle Royal, and in the USFS's Boundary Water Canoe Area in northern Minnesota where indirect attack or a confinement strategy may be used in areas of large federal ownership to meet agency specific land management objectives.

E. Tactics.

1. Tactics will usually involve the use of mechanized line construction by tractor and plow or dozer units reinforced by hand tool crews.
2. In some parts of the Northeast water lines or variations involving the use of foam and water will be the primary tactic for suppression. Handtools such as the backpack pumps, fire rake, shovel, McLeod tool and fire swats are standard equipment for fire agencies of all types.

3. Volunteer Fire departments are a major resource used by many of the states and some federal agencies. Depending upon the particular area, their wildland capabilities will vary from a few structural engines that will not leave a hard surfaced road to those that have highly specialized wildfire equipment.
4. Limited use is made of aerial suppression equipment. Helicopters with foam injection buckets, agency owned or contracted aerial tankers and single engine air tankers (S.E.A.T.) are used in Maine, Michigan, Minnesota, New Jersey, Pennsylvania, and Wisconsin. Federal and state agencies may share equipment under "Call When Needed" contracts. In Minnesota, the state and USPS use a small fleet of float equipped Beaver aircraft for suppression, detection, and transportation. Extensive use is made of state owned aircraft for detection and direction of ground forces on going incidents. Density altitude is not usually a problem for aircraft operations in the northeast.

F. Special Considerations.

1. Safety

Check with your local resource advisor for specifics, but some special safety problems you may encounter are:

- a. Black Bears - Most likely to encounter them in northern Minnesota, northern Wisconsin, and northern Michigan. Usually will leave you alone, but in a drought year when there is an absence of natural food, such as berries, they will raid camps in search of food. Proper storage of open food, fresh meats, vegetables, and garbage will usually prevent a visit by this critter.
- b. Snakes - Cottonmouth water moccasins, copperheads, and rattlesnakes are the three varieties of poisonous snakes found in the Northeast. The moccasins are usually found in southern Illinois, Indiana, Ohio, Missouri, and West Virginia. Copperheads are found in the same states as well as Pennsylvania. Rattlesnakes are Minnesota, Iowa, Illinois, Indiana, Ohio, Pennsylvania, New York, West Virginia, and Missouri.

- c. Diseases - Lyme disease is not fatal, but is a serious concern because of the delayed appearance and the side effects. It is tick borne. Rabies can be a local problem in some areas. Giardia, or beaver fever is present in many of the waters of the northeast.
- d. Miscellaneous Hazards - Poison ivy and poison sumac are common. In some areas they can be a major problem. Abandoned mine shafts, tunnels, caves, quarries, open pit mines, and exploration holes are present in some areas. Many of these also serve as dens for poisonous snakes.

II. SPECIFIC FUELS

Unique Fire Situations.

Maine - Maine is the most forested state, on a per acre basis, of any state in the United States. It also has the least public land ownership of any state - less than 2 percent. It has a state fire control organization which is directly or indirectly responsible for all forest fire protection in the state. Over 50 percent of its forest lands are spruce-fir type. Fire Behavior Models 4 & 10 best represent this fuel type. Maine has the most lightning fires of any state in the northeast.

New Jersey - Within 35 miles of New York City and Philadelphia rests 1.2 million acres of forest area known as the New Jersey Pine Barrens. It is composed of highly flammable pine types that have a long history of fire. Fire Behavior Model 4 is used for this fuel. Fires in this area occur with regular frequency and cause major damage, loss of property and, in some instances, loss of life. An aggressive, direct attack with the occasional use of backfires is the tactic recommended here.

Pennsylvania - Primary forest type for the Keystone State is Oak-Hickory. Use Fire Behavior Models 8 and 9. Over one million acres of Pennsylvania wild land suffered mortality from the oak leaf roller. In addition, it has been severely damaged by the gypsy moth. The topography of Pennsylvania is some of the more rugged in the Northeast area. The encroachment of second homes into this area has added problems to their suppression efforts. Tactics in this fuel are aggressive, direct attack, use topography and natural barriers and burn out lines once they are constructed.

A. Lake States Area.

1. Lake States area consists of Minnesota, Wisconsin, and Michigan.

2. Approximately 70 million acres of potential wildfire land.
3. Influenced by four of the Great Lakes - Superior, Michigan, Huron, and Erie.
4. Topography.
 - a. From flat to somewhat hilly.
 - b. Elevation from 500 to 2,300 feet.
 - c. Slope - generally not a problem in fire control.
5. Climate and Weather.
 - a. Four seasons.
 - b. Precipitation - 28 to 32 inches.
 - c. Winds - prevailing southwest to west.
6. Fire Season and Fire Conditions.
 - a. Normal fire season is April through June, with a second season from mid-September to late October or early November. The crown fire season will usually begin in mid-April and end in late May or early June. Jack pine seems to be most susceptible to crowning when it is pollinating. Drought conditions will extend the crown fire season into late summer and early fall.
 - b. Critical weather preceding a crown fire will usually be:
 - (1) Winds from SW to W at 8 - 12 gusting to 25;
 - (2) Temperatures of 65 degrees or more. Above 75 degrees in spring or fall indicate potential problems;
 - (3) Humidity of 30 percent or less. Below 30 percent expect erratic fire behavior and below 20 percent look for things to explode;
 - (4) Fuel moisture of 8 percent or less in the 10-hour sticks and 5 percent or less in the 1-hour readings;
 - (5) Usually occurs during or on the back side of a high pressure area.

B. Problem Fuels.

1. Pine fuels.
2. Muck and peat fuels (spruce-bog).

C. Jack Pine.

1. Predominate fuel.
2. Medium to heavy density.
3. Contiguous arrangement of live and slash fuel.
4. One thing to remember about surface or grass fuels is that they are perennials and do not automatically brown off each summer. They will recover from drought with some rain, and can reduce fire spread in many instances. On the other hand, they will tend to stay green during dry weather and burn quite readily if ignited.

D. Pine Fire Problem.

The major fire problem is a crown fire in a jack pine or red pine area. These are fast burning fires that can run in excess of a mile per hour and be all done in one day's duration. It may bum up to 15 miles during this period of time with spotting 1/4 mile or more in advance of the head. Normal fire run will be until dark or change of fuel type, but fires have been known to run through the night.

E. Crown Fire Strategy.

Plan for a large fire. Under crown fire conditions a fire can easily reach 1,000 acres in the first hour. The Mack Lake Fire of May 5, 1980, had a sustained rate of spread of 2 mph the first three hours. (176 feet per minute). The next 2 1/2 hours it dropped to 1.2 mph or 100 feet per minute. It burned 24,790 acres in one afternoon. Individual runs of 6 mph or 528 feet per minute have been reported.

1. Work the flanks. Try to pinch or narrow the fire at every opportunity.
2. If you are planning back fires, allow an hour to two hours to carry them out, otherwise spotting will negate your efforts.
3. Plan to control or reduce the head when:
 - a. You get a change in fuel types.
 - b. You get a change in weather conditions.
 - c. Usually nightfall will help you.
4. Control confusion.

5. Maintain awareness of weather conditions.
 - a. Prepare for turning action of fire as front passes.
 - b. Expect spotting to be up to 1/2 mile ahead of the main fire.
 - c. There are experienced fire weather forecasters in each of the three states. They are familiar with the vagaries of the Hudson Bay high, as well as the influence the Great Lakes have on your fires. USE THEM.
6. Remember, land ownership patterns here do not allow the luxury of writing off large acres of government land for back fires or indirect attack. Private land patterns require an effort to protect every acre of land.
7. Resource Deployment.

Most fires are divided into divisions, and if structures are involved, zones, early on to facilitate control of the suppression effort.

- a. As you stand at the origin of the fire and look toward the head, the usual deployment of equipment and personnel is 1/4 to the left flank, 1/2 to the right flank, and 1/4 floating with the head to take advantage of any changes in fuel type, natural barriers, or other events which will help narrow the head. This tactic is used because in almost all cases the fire will be moving from southwest to northeast and will be driven by a wind that will be changing to the northwest as the frontal system passes.
- b. Many of the local agencies will have designated preplanned zones to handle interface activities. These will be assigned to the structural force under the control of an experienced structural fire person. A guideline for planning and assignment is one structural engine for each structure to be protected for one hour.

Needless to say there will have to be a hard decision made on what is going to be defended and what will be written off because there usually will not be enough equipment available to go around!

10. Fire control tactics are based on a highly mechanized fire control force backed up by personnel, especially in mopup. Air tankers and helicopters are usually not available for the first day. In some instances they might not be available at all.
11. Use equipment effectively, do not waste tractor-plow effort. Do not underestimate the capability.
12. If fire runs into the night:
 - a. Increase aggressiveness - attempt to control as soon as possible.
 - b. Complete line to secure.
 - c. Do not wait for next day. (Equipment should be equipped for night use.)
 - d. Begin mopup.

F. Equipment Assignment - Fireline Tactics.

1. Tractor-plow Unit.
 - a. Will construct line at various rates, depending on cover and fire behavior. Blade is not for line construction but to clear slash and debris for line building.
 - b. Tractor-plows should be assigned in tandem if available and should build line as close as safety will allow. Burn out line behind tractor-plow. Use caution - be prepared to yield to fire.

No UNBROKEN LINE behind tractor-plows, PATROL must be maintained. Aircraft surveillance can be utilized but hand tool crews are best. Maintain constant availability of communications.

Fire is moving at a relatively fast rate - do not lose control of equipment.
 - c. Line placement should utilize all natural openings, skidways, hardwood ridges, or other breaks. Do not depend on roads to stop a crown fire.

- d. Line placement into plantations requires extreme caution and operators must have a planned escape route. Demands highly skilled operators knowledgeable of crown fire behavior.
- e. Line placement approaching the head of fire on the right flank must be done with extreme caution. Tractor-plow operator may become involved with spot fires and developing head of fire.

Explosive fire conditions - rapid swings of the fire flank are to be expected. Tractor-plow line construction rates for 450 and 350 class tractors allow tractors to overtake fire head.

Actively develop and improve tractor-plow line of right flank. BE PREPARED to yield if frontal action turns fire. All equipment must begin working fire in new direction.

2. Volunteer Fire Departments.

Maintain contact with their equipment. Do not allow the resources to be wasted. Structural fire protection is their key responsibility; however, if a favorable condition is reached, allowing for a stand on a road, hardwood area, etc., the fire department tanker capability can be utilized for pre-wetting and line holding. Many will have extensive wildfire experience - but make certain of levels of experience.

G. Modification in Crown Fire Strategy and Tactics.

Michigan - Use same basic strategies and techniques. Some equipment is the same, such as the JD-450 unit, but also use rubber tired skidders with plowers, armored 6x6 tankers with a plow and armored 6x6 tankers to build and hold line. Engines follow tractorplow units, they do not lead it.

Minnesota - Aircraft used in control of fires. Retardant is used on flanks, primarily to slow the fire spread in order to allow line construction equipment to control fire flank. Retardant drops are not used at the head of a running jack pine crown fire. (May be rare exceptions). Basic fire control strategy and tactics are similar to Michigan and Wisconsin.

III. MUCK AND PEAT FIRE PROBLEM

A. Definition and General Description.

Peat is raw and partially decomposed plant remains accumulated under conditions of excessive moisture. For practical purposes, peat soils typically contain a great deal of woody and rooted material and are brownish in color. Muck soils are fine, fully decomposed with a characteristically dark black color.

B. Moisture Retention.

Organic or muck soils hold several times more moisture than mineral soils. The amount of water held is dependent on the type of organic soils and degree of decomposition.

C. Time Period to Produce.

It takes 100 to 500 years to produce a foot-layer of residue. The rate depends upon plant cover and environmental conditions. Depth may be 40 feet or more.

IV. STRATEGY

A. Planning for the control and suppression of a fire involving muck or peat lands will often require planning for two distinct fire problems.

1. Control and mopup of a surface fire.
2. Control and mopup of a ground fire. The control and mopup may require different equipment and personnel to meet the needs of each problem.
3. If a Fire Team is requested to assist in the control and suppression of a muck or peat fire in the Lake States, it should be assumed a severe drought condition exists.

B. Strategy Planning.

1. Control and mopup of surface fire - fuels.
 - a. Surface fuels involved.
 - (1) Spruce - bog (patchy).
 - (2) Grass meadow.
 - (3) Spruce, balsam, tamarack swamps.
 - (4) Dense brush.
 - (5) Leather leaf bog.
 - (6) Farm lands, drained.

- (7) Aspen - scrub oak.
- b. Size of area involved.
- c. Depth and condition of muck or peat (affects surface fire control).
 - (1) Accessibility.
 - (2) Water table.
 - (3) Ability to support equipment (flotation).
 - (4) Availability of water source.
 - (5) Amount and condition of ground fire.
- d. Values threatened.
 - (1) Farmland.
 - (2) Highways.
 - (3) Homes, subdivision.
 - (4) Other.

2. Attack Plan.

- a. Indirect.
- b. Direct.
- c. Combination of both.

In most cases the attack plan will consist of both direct and indirect attack on portions of the line.

3. Plan to control fire spread as quickly as possible.

- a. Do not intentionally allow seemingly safe areas to burn when peat or muck is involved with a surface fire. To do so may require expensive mopup.
- b. Plan to suppress surface fire as quickly as possible and mop up completely.
- c. Determine how line construction is to be accomplished and equipment and personnel needs.
- d. Determine if fire may spread into adjacent fuels; e.g., Jack pine, spruce or other problem fuels (drought condition -- will affect personnel and equipment needs and strategy to control).
- e. Determine if fire may become involved with high value farm lands.

4. Do not underestimate problems.
 - a. Fire involving muck and peat require a great deal of initiative and adapting of equipment to meet needs.
 - b. Set up equipment maintenance program. Muck and peat fires raise havoc with equipment.
5. Set up and monitor safety program.
 - a. Injuries to firefighters.

Safety -- It is extremely important that proper training and clothing be provided to crews assigned to control and mop up of muck and peat fires.

(1) Wearing apparel.

- (a) Helmets.
- (b) Gloves.
- (c) Goggles.
- (d) Face masks (dust).
- (e) Snug fitting coveralls.

(2) Foot gear.

- (a) Laced 10" boots.
 - (b) Rubber boots.
 - (c) "Bean" boots.
- (3) Do not allow other types of boots. Stepping into hot burning peat or muck could result in severe burns.

(4) Common injuries.

- (a) Eyes - dust and blowing ash.
 - (b) Falling material - trees burned off at the roots. No warning.
 - (c) Tripping.
 - (d) Burns.
 - (e) Typical injury prone area.
- b. Involvement with highways (smoke).

C. Construction of Firelines.

1. Lines must be constructed to mineral soil or below water table.
2. Care must be used in constructing lines with tractor-plows or bulldozers when working over peat or muck. You will probably be only able to make one pass. After vegetation and material supporting the tractor has been disturbed, any further action may result in getting the unit stuck. Wide tracks (36+ pads) are available from private sources for hire.
3. Lines constructed through peat or muck that do not reach mineral soil or the water table should not be depended on to hold the fire. They will normally restrict the fire for 24 hours. After that, either new lines must be constructed or plow lines wet down.
4. When constructing lines through peat or muck, do not push material onto the fire side. To do so will result in a difficult and costly suppression problem.
5. Equipment used in line construction.
 - a. Plowing.
 - b. Bulldozing.
 - c. Hand crews.
 - d. Line to mineral soil - shallow peat.
 - e. Trenching, backhoes, etc.
 - f. Blasting.
 - g. Drag line, etc.

D. Suppression of Muck and Peat Fires.

1. Suppression of muck and peat fires using water. Water -- The use of water is effective, when available in an unlimited supply, or at least sufficient to meet suppression needs.
 - a. Effective on large fires or where dense surface fuels are present.

May be necessary to pump long distance.
 - b. Requires manpower and equipment to set up and operate.

- c. Pumping equipment, irrigation pipe and specialized hose lays are required.
- d. Difficult to deploy through downed material.
- e. Require continuous operation to be effective.
 - (1) May require pumping for weeks or even months.
 - (2) Equipment must be moved every 6 -10 hours.
 - (3) Sprinkler system must overlap.
 - (4) Becomes a mess.
 - (5) Care must be used to not lay hose over burning peat or muck.
 - (6) When pumping from sources near fire, beware of water table and influence on fire.
 - (7) If water source is moving, will probably support pumping.

- f. Water source may be several miles from fire. Do not let this restrict you.

The use of water in suppressing muck and peat fires is usually an expensive and time consuming task. On large fires or where dense surface fuels are present, water is the only practical means of suppression.

It may be necessary to pump water for weeks or even months. Large quantities of water must then be available.

- 2. Suppression of muck and peat fires using dry methods or combination of water and dry.

The dry method of suppressing a muck or peat fire is usually less costly and will require less time and personnel to suppress.

- a. Blading - to mix and cool material - effective on areas where surface will allow. Mixing of burning material with cool, damp peat will suppress the burning material.
- b. Discing - breaking up surface material and mixing unburned, cool, damp peat. Discing is effective where fire has not burned down into peat or muck. Particularly effective on drained farm land. Begin immediately.

SOUTHEAST

I. GENERAL

The southeastern section of the United States can be divided, for fire suppression purposes, into three geographical regions:

- Appalachian Mountains.
- Piedmont Plateau.
- Coastal Plains.

Note that there are other unique geographical regions in the southeastern United States, such as the Everglade Swamp in Florida and the Pocosins in North Carolina, that have unique problems.

There are two separate fire seasons in all the geographical regions, fall and spring. Fall fire season usually begins in October with leaf fall and ends when the winter rains and snow begin in December. The spring fire season usually begins around March 1 and extends into May when vegetation begins to grow. Spring fire season is characterized by warm, windy days and cool nights, and this is usually when the most severe fires occur.

Each geographical region has unique fire suppression problems. Four major factors that affect strategy and tactics in these regions are: topography, weather, fuels, and the degree of mechanization of fire suppression forces.

Topography is the most important factor affecting fire behavior in mountainous regions but is a minor concern in Piedmont and Coastal Plains, (where weather and fuels are the major elements affecting fire behavior).

In the flat woods of the coastal plains and rolling topography in the Piedmont the key word is mechanization. Dozers range in size from a Type III equipped with a fire plow to a Type I using a blade. They can construct more fireline in a given time than 25 to 100 line personnel. Crews to patrol burnout and backfire are needed. Some fires with a heavy tractor operation, will have more tractor personnel than firefighters.

II. WILDLAND FIRE SUPPRESSION

- A. Wildland fires in the southeast quite often involve both public and private land. Further, the public land may be under the jurisdiction of more than one federal agency as well as a state agency.

Generally, the agency that establishes the original incident command on fires involving more than one agency remains in control of that fire. Most states have cooperative agreements with federal agencies within their boundaries to this effect. There are provisions in these cooperative agreements allowing a different agency to assume command of a fire that is burning within their jurisdiction or, more often, to establish a joint command.

Incident management teams should be aware of any cooperative agreements in effect. The agreements spell out pay rates for personnel and equipment and areas of responsibility.

- B. Most of the land area in the southeast is owned by the small private landowner and forest industries. Generally speaking, state forestry organizations are responsible for all fires burning on private land. In situations involving industrial forest lands, state and industrial personnel cooperate closely, but state personnel still have ultimate responsibility. You will often see forest industry personnel and equipment working under state direction on fires not on industry land.
- C. You should be aware of a basic difference in philosophy between state fire organizations and most federal agencies. State organizations are generally more cost conscious; they just don't have the money!
- D. Most southeastern and south central compact states have adopted ICS, but their personnel are at different stages of acceptance and knowledge. When working with some state agencies they may not be aware of who a line officer is and you will probably not get an Escaped Fire Situation Analysis (ESFA). Incident management teams may have to write the delegations of authority for them. Help them out, they may not be up to standard in all areas, but work with them. They can be a valuable resource.
- E. Southeast firefighting personnel may be a mixed bag indeed. While few state organizations handle all fire responsibilities, most depend heavily on volunteer fire departments, a system of part-time forest wardens, and pick up firefighters to supplement their forces.

F. Federal Excess Property Program (FEPP) - southeast has more excess property than the rest of the United States put together.

- Aircraft.
- Large Engines.
- Small Engines.

Equipment rental agreements with volunteer fire departments using FEPP cannot charge the federal government for use of that property. They can charge for equipment they have placed on the property (i.e., tank, pump, etc.).

III. GEOGRAPHICAL REGIONS.

A. Appalachian Mountains

The Appalachian Mountains region comprises approximately 50 million acres of forest.

1. Fuels.

Fuel Model 9 - mixed upland hardwoods - pine; 10+ tons per acre; Fuel Model 7 - heavy laurel and rhododendron under upland hardwoods and pine; 15-20 tons per acre.

Fuels in the mountain region consist of upland hardwoods and hardwood litter interspersed with pine on the drier sites. Most of the upper slopes have mountain laurel in the hardwoods. Rhododendron grows in thickets in the more moist areas. Ozark and Ouachita mountains will not have laurel or rhododendron.

2. Topography.

The Appalachians vary in height up to 6,684 feet in elevation (Mt. Mitchell, North Carolina). Land is often steep and rocky with large outcroppings of granite, sandstone, limestone, or shale. Much of this area is inaccessible except by foot. You can be within a few miles of a fire and have to travel 15 or 20 miles to get to the base of the mountain on which the fire is burning.

3. Weather.

During winters of light snowfall the hardwood leaf litter and dead herbaceous material are more fluffy (not packed by heavy snowfall) and fire will spread at a rapid rate. Also, in high winds the fire danger may be underrated because rolling and blowing leaves are not considered. There may be a leaf fall after a bum and rebum will occur if you don't do a good job of mopup.

4. Tactics and Strategy.

Upslope runs and sustained rates of spread are more common in the mountains than the other geographical regions.

Fires may burn for several days but usually make their main run on the first or second day. Heavy ground fuels and cull trees make it difficult to mop up.

- a. Generally speaking, when fighting fires in the mountains in this region, try to get to the top for major suppression efforts.

Reasons:

- (1) When a fire makes a run you don't usually catch it until it reaches the top.
- (2) Due to accessibility, equipment is generally only useable on ridgetops.
- (3) Tactically, attack the fire indirectly and backfire the line to construct a sufficiently wide break to hold the fire.

- b. If a fire is making a fast run and is very hot you may have to make a flanking attack. If you must flank a fire remember:

Your major suppression effort, all other factors being equal, should be on the east flank first. Dry, cold weather fronts can cause a 90 degree wind direction change in a short time, creating a new front along the east flank.

5. Safety.

- a. Appalachian ridges and slopes often have shallow soil and loose rock. Tractor operation can be hazardous. Ledges and cliffs created naturally, or by strip mining, can be a problem to people at night, as well as to equipment.
- b. Backfires are often started by local people from streams, trails, etc. to protect their own property or, in some cases, by arsonists who use the confusion to start additional fires.
- c. Heavy vegetation can hamper fire suppression and movement of personnel.
- d. You may need law enforcement personnel to escort crews.

6. Resources Available.

States in the southeast have some type of aerial support in times of emergencies. Tactics used are usually concerned with helicopters with water buckets or fixed tanks making multiple drops in support of ground forces rather than attacking the fire in a direct suppression effort. Federal lands generally have both helicopters and aerial tankers available. Due to cost of large airtankers, states may not opt to use this resource. A new tool recently introduced is a "scoop" tanker used where large bodies of water are available. It is not widely available, but is very effective.

The helicopter with bucket or fixed tank is a very effective tool in the southeast due to the proximity of water sources. In much of the mountain region a turnaround time of 5 to 6 minutes isn't unusual. Use of Class A foam is on the increase.

Type III dozers with fire plows and communications are widely available. Handtools are effective and the first line of defense. At times it isn't necessary to get mineral soil to stop a running fire in the front attack. Removal of the loose leaf litter is often enough and that can be accomplished by leaf blowers and handtools. Another important tool is the All Terrain Vehicle (ATV) which makes accessibility easier and helps move supplies and equipment.

7. Special Considerations.

Strip mines and haul roads for timber or coal are numerous in some areas, allowing access, and acting as a fire breaks. They are not on any map but local forestry personnel will know about them.

Caution: It is easy to get trapped on steep slopes created by over burden pushed off the strip benches. Stay on the benches and construct indirect fireline. Post Lookouts if needed.

8. There usually is no problem with density altitude: Most of southeast is less than 5000' MSL; 80% less than 1000' MSL.

B. Piedmont Plateau

The Piedmont Plateau comprises approximately 50 million acres of forest.

1. Fuels.

Fuel Model 9 - Mixed hardwoods-pine.

Fuel Model 1 - Open southern pine plantation.

Fuel Model 9 - Closed pine stands.

Most of this region is covered with mixed hardwood pine forest. Fuel continuity is frequently broken by open spaces where land has been cleared for agricultural purposes.

There is a wide range of fuel sizes and densities. Many areas have hardwood fuel types not unlike the mountain regions. There are other extensive areas of loblolly and slash pine plantation ranging from seedlings to pole and saw log size timber.

The wide range of fuels in pine plantations makes fire suppression difficult and hazardous. The younger plantations have large amounts of light fuels (herbaceous materials, pine litter, seedlings, hardwood debris). The sapling size plantations will easily crown given proper conditions and their density hampers working with equipment.

Fuel types near streams and wet bottoms consist of mixed bottomland hardwoods but with less leaf litter than the upland sites. Also, there is often heavy cover of Japanese honeysuckle which is usually not as flammable as loose leaf litter. This cover is not usually a "Fuel Ladder" since it is shaded out in pine fuels where crown fires occur.

2. Topography.

Approximately 213 of the Piedmont is forest land. The rolling topography consists of deep, clay soils and numerous small streams. Except in local situations, such as river bluffs, slope generally has little effect fire behavior.

This area historically has been the center of agriculture in the southeast. The region has been burned repeatedly by local residents and only in recent years have fire prevention activities shown results. People still cause most of the fires in this region, either through debris burning or arson. Railroads also cause serious problems in some areas. Claims personnel need to be aware of how the fire started.

3. Weather.

As in mountains, fires in the Piedmont area usually burn the most acreage during the first day. Fires tend to die down nightly and the rolling terrain allows much suppression activity to be done at night when the humidity recovery is high. There are exceptions to this and weather forecasts are important.

4. Tactics and Strategy.

a. Fires burning in mixed pine-hardwood fuel types are fought differently than pine plantation fires:

- (1) Slow moving fires are attacked direct and at the head. This is perfect terrain to use dozers in conjunction with burnout, and this tactic is used extensively.
- (2) Fast moving fires are attacked at natural breaks or by flanking the fire with mechanized equipment with burnout. .

In most cases where natural fuel types prevail there will be breaks in the fuel continuity by roads, agricultural land, or streams. These are excellent breaks from which to make a stand against the fire and should be used where possible. Again, backfiring is mandatory if these lines are to be effective.

- b. Young pine plantations create a totally different situation than natural fuel types. When conditions are such that major fires are possible it is usually not practical to try a frontal attack on a plantation fire.

In some parts of the Piedmont and Coastal Plains extensive reforestation programs have created literally miles of different aged plantations, broken only occasionally by natural forest types.

The situation is not as bleak as it sounds. All plantations of any size have a system of fire breaks and/or roads. Also, streams, branches, and wet drainages remain in hardwoods with little ground cover, thereby creating a natural avenue for equipment and a good break in fuel continuity.

- (1) Fires in intermediate and young pine plantations are usually attacked on the flanks with mechanized equipment and burned out and, if natural breaks are available, at the head with backfiring.

Caution is the watchword and you must have an experienced person handling the frontal attack.

Important: Effective burning out is necessary in this situation. Burnout must be coordinated with line construction. The burnout must be set at that specific time when the wildfire is "drawing" the air toward the fire from the line, preventing the burnout from spotting over the line.

- (2) On extremely fast moving plantation fires it is unlikely that a frontal attack will be successful. In this situation about all you can do is to keep the width of the fire at a minimum by flanking attack and make your main stand after the fire moves out of the plantation and is burning in other fuel types.

5. Safety.

Due to the rolling terrain and ease of equipment operation it is easy to take fires for granted in the Piedmont.

Special caution should be taken when dry, cold fronts move through the area and when working in the dense fuels of pine plantations. Backfiring and burnout, while commonly used,

must be assigned to experienced personnel and coordinated directly by the operations section chief or incident commander. Escape routes for personnel and equipment are extremely important! It is easy to become careless when on a dozer.

6. Resources Available.

- a. Plantation fires burn swiftly and cover much land in a relatively short time. However, they usually burn most of their acreage in the first burning period.
- b. Fire behavior in the Piedmont is often influenced by weather systems that produce extreme behavior.
- c. People from nearby urban areas are building summer and full time residences in heavily wooded areas of the Piedmont. Property values can be high and are usually given high priority for protection if threatened by wildfire.

C. Coastal Plains

The Coastal Plains comprise approximately 100 million acres of forest.

Fuel types in the coastal plains region are determined somewhat by the land drainage patterns. They can be divided into:

- Sandhills.
- High Pocosin.
- Low Pocosin.

1. Sandhills

a. Fuels

Fuel Model 1,5 - 10 tons/acre and Fuel Model 9 - 10+ tons/acre.

Fuels in this area are often loblolly, longleaf, or slash pine with natural grass understory. Pine stands predominate but mixed hardwood stands similar to the Piedmont regions are common.

Another common fuel type is palmetto-gallberry under pine overstory.

Soils are well drained sandy soil and ground litter consists of pine needles, grasses, herbaceous materials, and hardwood understory.

Wide expanses of young pine plantations are found in the sandhills creating the same high hazard areas as those plantation in the Piedmont.

b. Topography.

Nearly flat topography with meandering streams and high water table, but generally very accessible by limited mechanized equipment. The Everglades National Park is so flat the highest point in the park is 10.5 feet in elevation.

The Coastal Plains has had some of the most severe fire problems in the past. While access is readily available to most areas, there are large, unbroken areas of forest land.

Single fires of 150,000 acres have burned in Coastal Plains regions, and fires over 10,000 acres are not uncommon during average fire years. Part of Texas and Oklahoma are in this region.

c. Weather.

Due to the fast moving dry cold fronts, fire in the coastal plains usually burns the most acreage the first day. Due to the increase in RH the fires tend to die down nightly. The rolling terrain and increase in RH, allow much suppression activity to be done at night. There are exceptions to this, such as dry cold fronts.

d. Tactics and Strategy.

Fire behavior and tactics here are practically the same as those in the Piedmont regions. Similar fuels exist and weather patterns are much the same. Often palmetto-gallberry fuel type is encountered in association with pine overstory.

e. Safety

One significant difference firefighters should be aware of is the sandhill regions tend to have an abundance of light fuels that dry out quickly. The area may receive substantial rain one day and burn fiercely the following day. The sandy soils do not hold moisture like the Piedmont clay soils.

f. Resources Available.

- 1) Dozers with blades and fire plows **as** well as volunteer fire department engines and specialized foam engines.
- 2) Many of the agencies are using swamp buggy engines with wide, low pressure tires for maximum flotation and minimum impact. Bombadiers, a tracked vehicle without a blade and with water handling capability, are also used.
- 3) Again, helicopters with buckets or fixed tanks are effective tools because of water sources. North Carolina State agricultural airtankers can carry 800 hundred gallons of retardant.
- 4) Some use of agricultural airtankers in other states.
- 5) Very few (if any) Type I helicopters in southeast.

2. Pocosins - High and Low.

a. Fuels.

The fuels found in the pocosins are similar to those found in swamps.

- 1) High Pocosin 1. Fuel Model 2, 30 - 40 tons/acre.

Mixed hardwood timber and evergreen brush from 6 - 20 feet tall. The leaves of the brush are high in oil content and highly flammable during fire seasons. Some areas have pine overstory. There is usually heavy ground litter on shallow organic to deep peat soils. Fuels are often as much as 40 tons/acre. Heavy understory of shrubs, vines, and seedlings, and young trees make up most of the fuel.

2) Low Pocosin - Fuel Model 7, 10+ tons/acre.

Consists of mixed hardwood brush, generally less than six feet tall. Evergreen brush is high in oil content and very flammable.

Low Pocosin generally has less ground litter and stands of shrub pond pine and Atlantic white cedar are occasionally found, although generally there is no overstory.

Soils are shallow organic soils or deep peat, and fuels range up to 10 tons per acre of vines, herbaceous material and conifer or hardwood brush.

b. Topography.

Pocosin is literally a "swamp" on a hill. This will be a swampy area but with an elevation of 250 - 300 feet above sea level. They have been drained extensively by canals and ditches to create farm land or to plant southern pine. The soil from these canals and ditches usually become roadways with no access to the timber. The soils and peat dry out creating severe burning ground fires.

c. Weather.

In heavy fuels, such as in high Pocosin, flank attacks are the only practical strategy in most cases. Consider weather forecasts. Cold frontal systems cause the same problems of shifting winds in the coastal plains as they do in other geographical areas of the southeast. You also need to consider sea breezes. As land heats during the day, normal wind patterns may become erratic due to sea breezes if the fire is in the eastern part of the coastal plains.

d. Tactics and Strategy.

Is there a need for a bridging crew?

Due to almost flat terrain, fuels and weather are the dominating factors in fire behavior in the Pocosin areas of the southeastern United States.

Head Attack.

Head attacks can be made where fuel is light and maneuverability is possible. In these situations, crown fires are not a great hazard. Most commonly used in low Pocosin.

A head attack is also a practical strategy when natural or man-made breaks occur in the fuels, such as canals and roadways. Line construction for a head attack should consist of multiple lines looped around the fire head and backfiring the line nearest the fire. If possible, tying the line to a barrier is superior to looping it around the head of the fire.

Caution - spotting is always a problem in these fuels and even more so when the backfire and fire's head meet.

Another method of head attack is to construct two parallel lines at the head of the fire and burn out between the two lines. Distance between the two lines would be dependent on the distance the fire is spotting.

Head attacks can also be made without backfiring if necessary. Again, multiple lines are effective as well as using serial application of retardant in conjunction with tracked equipment and fire plows.

Indirect attacks are almost always necessary to allow time for sufficient numbers of lines to be constructed.

Do not attack the head of a crowning fire. Let it run and work the flank or rear.

If all things are equal, attack a fire counter-clockwise to counteract the clockwise shift of winds if frontal systems move through the area. If there is no prospect of weather changes, attack hottest flank first or flank with most loss potential.

Attack downwind from the base of a fire and plow close enough to allow the back fire to be pulled by the indraft from the main fire. Burn out line as it is constructed.

Attacking upwind from natural-breaks should be done cautiously! You must construct firelines farther from the flank for safety reasons. Working close to the flank might allow equipment to be trapped by split heads or finger of fire.

Again, caution is paramount during upwind attacks on large fires.

Ideally, if sufficient personnel and equipment are available, both flanks should be attacked downwind at the same time. If natural breaks are available a head attack can be made in conjunction with the flank attacks.

e. Safety.

Safety is always the first consideration in fire suppression and it is doubly important in the Pocosins. These areas have hazardous fuel types and are difficult to traverse. Drainage ditches and canals where soil has been removed fill with water and are difficult for equipment to cross. Bridging crews may be necessary to construct temporary bridges.

Dense vegetation and unsure footing at times make it practically impossible for people on foot to move rapidly. All kinds of critters will be pushed out by the fire.

Attacking the head of fires is commonly done, but is dangerous. Extreme caution must be used even in an apparently routine fire.

Never allow direct attack on flanks on an upwind attack. Make an indirect attack and use an aerial scout.

Humidity is usually high. It may take time for people to get used to breathing such moist air.

f. Resources Available.

- 1) Dozers with high flotation tracks.
- 2) Helicopters with buckets or fixed tanks.
- 3) "Specialized" tracked vehicles for swamp operations.
- 4) Pumps and hoses.
- 5) Airtankers

g. Special Considerations.

- 1) Fires burning in peat and deep organic soils will burn down to the water table. In periods of drought it may be necessary to irrigate firelines with high volume pumps to completely extinguish fires.

A common observation during wildfires in dry periods is the soil burning away from tree roots causing them to topple over as the fire advances.

- 2) Always use two dozers together in wet or swampy terrain. One can help the other get unstuck; or in some cases, one dozer will plow while the other pulls.
- 3) In wet or swampy terrain, have equipment set a course as close as possible on a straight a line. Plan lines to minimize turns since this is where the dozer is most likely to get bogged down.

Never plow the same line twice and cross previously plowed lines at right angles. It is not uncommon to have 3 - 4 dozers on initial attack and 15 - 20 on extended attack.

D. Swamps.

1. Fuels.

Fuel Model 7 - Sand Pine - sand pine has a very small range and the largest concentration is a block of 280,000 acres on the Ocala National Forest in North Central Florida. It is a fire species. Usually there is one fire per generation and usually this is a high intensity crown fire. Under normal conditions the sand pine scrub is virtually fire proof. This is primarily due to mature sand pine having a dense understory of evergreen oaks with little or no herbaceous ground cover.

Fuel Model 3 - Tall Grass.

Fuel Model 1 - Short Grass.

Upland Pine (Longleaf/Slash Primarily).

Historically, you are looking at a pine/grass understory. With the absence of fire, it becomes pine/brush understory or pine/palmetto-gallberry. It is basically a Fuel Model 2, for pine/grass and Fuel Model 7 for pine/palmetto-gallberry bush. With heavy loadings and needle drape upland pine can be Fuel Model 2 and 5 - 15 tons per acre in Fuel Model 7, dependent on the age of the rough.

2. Topography.

There are numerous swamps and lowlands in the southeast, located in the coastal plains. They are characterized by a low elevation and generally fragile ecosystem that requires special technique to combat the fires. If at all possible order up a micro-RAWS for weather. The topography for this area is flat flat flat!!!

3. Weather.

The weather for this area will be the same as the coastal plains.

4. Tactics and Strategy.

a. Tall Sawgrass.

The most effective tactic to use in tall sawgrass is to work when RH is high. Primarily between daylight and 0900. You can add another two hours or so when supported by water drops.

Fight the fire by flanking (direct attack) with flaps. The tactic is to start swatting at the rear of the fire, flanking the fire and gradually pinching off the head. In the areas of tall sawgrass there usually are some pockets of spike rush that are intermingled in with the sawgrass. Weedeaters with cutting blades can be used to cut a fireline. Connect the fireline to spike rush flats or to tie it into burned areas. From these cut lines you can bum out. Spotting is generally short range due to rapid consumption of fuels. Helicopters are used to support ground crews with water.

The most effective tactic to use in sand pine is plowing lines and burning out. If this does not work the strategy usually calls for going to a fuel break, such as a road and backfiring.

In dense stands, fires crown fairly easily and spread rapidly. Estimated spread rates of 5 mph and higher have been reported. Flame lengths have been estimated in excess of 100 feet.

Large fires typically occur between February and June. This is primarily due to fuel and weather conditions. While drought conditions may occur at other times of the year the foliage moisture and mineral content is not as critical.

The low moisture content of new and old needles occurs in March. Moisture content of old needles increases through the summer and reaches its highest value in August and September. Moisture content of new needles rises sharply to very high values in June and July and decreases through the rest of the year. The high values result from initiation of new growth.

The ether extractive in both old and new needles peaks primarily in March. Ether extractives and energy values for sand pine are generally higher than those for most other pines and they compare with the high values of California brush species.

Studies have shown that when large fires occurred the RH tended to be low (23 - 35%) and windspeeds high (9 - 20 mph). Visibility was very good (12 - 15 miles), indicating frontal passage or an unstable air mass.

b. Short Grasses.

Short grasses can be effectively worked during the day, except with high winds. Again it is crews with flaps along with water drops in support. The most visual cost effective tactic is to locate an area that is almost devoid of any heavy vegetation and ignite with an aerial ignition device. This requires an RH of 65 - 70 percent recovery just before sundown. You ignite an area, allow the spots to join and form a backing line, when RH reaches approximately 80 percent the moisture extinction takes over and the fire goes out.

c. Pine Types.

Scattered throughout the pine types are bays and ponds or wet boggy areas. When wet, these can be used as natural fuel breaks. If you have the opportunity to fight fire in these areas, one of the first questions to ask is, "will the bays stop the fire?" If they will, then you're in good shape. More than likely, they won't or you wouldn't have been called. If the "swampy" area is in a hardwood timber type, typically the fire will be a low intensity ground fire, but it will require handtool work cutting through peat or a deep litter layer. The ground will not usually support equipment. If it is a brush type, such as titi you may experience a running head fire in these bays.

d. Pine Plantations.

Pine plantations are going to play a larger role in fire suppression efforts in the next few years. With the Conservation Reserve Program, millions of pines have been planted. These plantations have large amounts of light flashy fuels. The sapling size easily crowns, the density hampers equipment and once inside of these it is like being a mouse in a shoebox, the only way you can see is up.

Fire behavior in these fuel types is primarily from live fuels and corresponds to the time since it was last burned. Any dead fuel will play a major role in fire activity, i.e., needle drape will encourage crowning.

Typically, you can expect 2' - 4' flame lengths and rates of spread (ROS) of 4 - 8 chains per hour on low to medium class days in lighter fuels. On moderate to high class days in light to moderate fuels expect flames of 4' - 10' with ROS of 8 - 12 chains/hr. On high class days in heavier fuels you can expect 15' - 20' flame lengths with ROS of 60 - 80 chains per hour. As a general rule, in southern pine one mile per hour is a good estimate to use on extreme fire behavior. However, in blow-up conditions, you may see these ROS go to 150 - 200 chains per hour with flame lengths in excess of 100 feet as crown fires develop.

Tactics to take on slow moving fires is to anchor into a road, stream, or any fuel break and attack the fire directly and cut off the head, burning out behind the dozer.

On fast moving and crowning fires, you back up to a fuel break, backfire and hope you can hold your backfire; if not, you get out of the way and let the head run. You work the base and try to flank the fire, burning out as you go. You can also plow a lot of lines ahead of the fire front to create a large fuel break.

5. Grass and Sawgrass Fire Behavior

FIRE BEHAVIOR YOU CAN EXPECT (3 – 6 mph eye-level winds).

	Backing		Forward	
	FL/ROS		FL/ROS	
Short Grass	2' - 4'	4' - 6'	12'-15'	80'-100'
Short Sawgrass	2' - 8'	4' - 6'	10' - 20'	40' - 80'
Tall Sawgrass	8' - 12'	2' - 4'	20' - 30'	20' - 60'

6. Safety.

- a) Roads - in this part of the country are a "ball-bearing" sand which requires high flotation tires or four wheel drive to travel. Always keep one foot in the black. Tall sawgrass (up to 12') is almost impenetrable and once in these areas, visibility is almost nonexistent. A compass is a must to keep oriented.
- b) In fighting grass fires, always carry fusees. Should you get trapped, you can quickly bum out a safety island. Don't try to outrun on foot.
- c) In the south the dozer operator position is the most dangerous job, because fires in the coastal plain are wind driven. Fatalities and burnovers have resulted from wind shifts while dozer operators and firefighters were directly attacking the flanks and head of a fire and not burning out.
- d) Stumps - dozers are notorious for getting hung up on a stump. The operator will many times hang around too long trying to save a piece of equipment. If possible work dozers in tandem.

- e) Due to the flatness of the land, communications will be a challenge.
- f) Snakes, getting lost or disoriented, inaccessible areas, alligators, poison wood, poison ivy, holes, boggy areas (poor footing) are all safety concerns to be aware of.
- g) Because of the many safety concerns there is not usually a night shift in the swamp areas.

GLOSSARY OF FIRE CONTROL TERMS

ABORT: To jettison a load of water or retardant from an aircraft.

AERIAL FUELS: All live and dead vegetation located in the forest canopy or above the surface fuels, including tree branches and crowns, snags, moss, and high brush.

AERIAL IGNITION: The process of dropping or dispensing an igniting device or material from an aircraft.

AGL (Above Ground Level): A term frequently used in aviation operations, usually in connection with a stated altitude.

AIR TANKER: Any fixed-wing aircraft certified by the FAA as being capable of transport and delivery of fire suppressant solutions.

ANCHOR POINT: An advantageous location, generally a fire barrier, from which to start constructing a fireline. Minimizes the chance of being out flanked by the fire while the line is being constructed.

BACKFIRING: A tactic associated with indirect attack, intentionally setting fire to fuels inside the control line. Most often used to contain a rapidly spreading fire. Backfiring provides a wide defense perimeter, and may be further employed to change the force of the convection column. Backfiring is a tactic which makes possible a strategy of locating control lines at places where the fire can be fought on the firefighter's terms. Except for rare circumstances meeting specified criteria, backfiring is executed on a command decision made through line channels of authority. See Burning out for difference.

BACKING FIRE: Fire spreading or ignited to spread into the wind and/or downslope.

BERM: In fire suppression, a ridge of soil and debris along the edge of a fireline resulting from line construction. May be created on the downhill side to stop rolling material.

BLACKLINE: In fire suppression, a blackline denotes a condition where there is no unburned material between the line and the fire edge.

BLOWUP: Sudden increase in fire intensity or rate of spread sufficient to preclude direct control or to upset existing control plans. Often accompanied by violent convection.

BREAK/LEFT OR RIGHT: Means "turn" left or right. Applies to aircraft in flight, usually on the drop run and when given as a command to the pilot. Implies a prompt compliance. Should be used only in an emergency.

BUCKET: Any device suspended by cables from a helicopter designed to contain and drop retardant or water onto a fire.

BURNING OUT: When attack is direct, intentionally setting fire to fuels inside the control line to strengthen the line. Burning out is almost always done as a part of line construction; the control line is considered incomplete unless there is no fuel between the fire and the line. See *Backfiring* for difference.

BURNING PERIOD: That part of each 24-hour period when fires will spread most rapidly, typically from 10:00 a.m. to sundown.

CALCULATION OF PROBABILITIES: Evaluation of all existing factors pertinent to probable future behavior of a going fire and of the potential ability of available forces to carry out control operations on a given time schedule.

CANOPY: The uppermost spreading, branchy layer of vegetation.

CARDINAL DIRECTIONS: North, south, east, west to always be used in giving directions and information from the ground or air in describing the fire, e.g., the west flank or east flank, not right or left flank.

CENTER FIRING: A method of broadcast burning in which fires are set in the center of the area to create a strong draft, additional fires are then set progressively nearer the outer control lines as in-draft builds up so as to draw them in toward the center.

CHECK LINE: A temporary fireline constructed at right angles to the control line and used to interrupt the spread of a backfire as a means of regulating the heat or intensity of the backfire.

CLOCK METHOD: A means of establishing a flight path to a target on a fire by reference to clock directions.

COLD TRAILING: A method of controlling a partly-dead fire edge by careful inspection-and feeling with the hand so as to detect any fire and extinguishing it by digging out every live spot and trenching any live edge.

CONDITION OF VEGETATION: Stage of growth, or degree of flammability, of vegetation that forms part of a fuel complex. Herbaceous stage is at times used when referring to herbaceous vegetation alone. In grass areas, minimum qualitative distinctions for stages of annual growth are usually green, curing, and dry or cured.

CONFINE A FIRE: To restrict the fire within determined boundaries established either prior to or during the fire.

CONSTRAINTS: Parameters or limitations on the use of specific suppression resources.

CONTAIN A FIRE: To take suppression action as needed, which can reasonably be expected to check the fire's spread under prevailing conditions.

CONTAINMENT: Completion of a control line around a fire and any associated spot fires, which can be expected to stop fire spread.

CONTROL A FIRE: To complete a control line around a fire, any spot fires therefrom, and any interior islands to be saved; burn out any unburned area adjacent to the fire side of the control lines; and cool down all hot spots that are immediate threats to the control line, until the lines can reasonably be expected to hold under foreseeable conditions.

CONTROL FORCE: Resources used to control a fire.

CONTROL LINE: A comprehensive term for all the constructed or natural fire barriers and treated edges used to control a fire.

COYOTE TACTIC: The "coyote tactic" consists of a progressive line construction technique involving self-sufficient crews who build fireline until the end of a shift, remain overnight (RON)-at/near that point, and then begin again on the next shift. Crews should be properly equipped and be prepared to spend several shifts on the line with minimal support from fire camp.

DENSITY ALTITUDE: The pressure altitude corrected for temperature deviations from the standard atmosphere. "Density altitude" bears the same relation to "pressure altitude" as "true altitude" does to "indicated altitude." In air operations, the altitude at which the aircraft "thinks" it is flying.

DEPLOYMENT ZONE: Deployment zones are very similar to safety zones. The key difference is that fire shelters must be deployed to insure firefighter survival in a deployment zone due to the available space and/or fire behavior conditions at the deployment zone location. See Safety Zone.

DIRECT ATTACK: Any treatment of burning fuel, e.g., by wetting, smothering, or chemically quenching the fire by physically separating the burning from unburned fuel. A suppression strategy in which resources are directed to work close to the fire edge.

DIVISION SUPERVISOR: An operations supervisor responsible for all suppression activities on a specific division of a fire.

DIVISION: A unit of a fire perimeter between designated relief, drainage, or cultural features. A division is supervised between the Task Force/Strike Team and the Branch. (Also see "Group.")

DOWN LOADING: A reduction to aircraft payload made to compensate for loss of performance due to increase in density altitude.

DOZER BOSS: A person responsible for supervising one or more dozers.

DOZER COMPANY: Any dozer with a minimum complement of two persons.

DOZER LINE: Fireline constructed by a dozer.

DOZER: Any tracked vehicle with a blade for exposing mineral soil.

DROP CONFIGURATION: The type of air drop selected to cover the target. Terms which specify drop configuration include:

SALVO - Drop the entire load at one time.

TRAIL - Drop tanks in sequence.

SINGLE OR DOUBLE DOOR - Drop a partial load.

DROP ZONE: The area around and immediately above the target, applies to retardant and paracargo.

DRY RUN: A trial pass over the target area by an air tanker.

DUFF: Forest floor material composed of the L (litter), F (fermentation), and H (humus) layers in different stages of decomposition. ,

DUMMY RUN: A simulated bombing run made on a target by the lead plane or air tanker. Used to indicate approach and target to air tanker and to check for flight hazards.

ENGINE COMPANY: Any ground vehicle providing specified levels of pumping, water, hose capacity, and personnel.

ESCAPED FIRE SITUATION ANALYSIS: A document approved by the line officer that outlines strategies to be used in suppressing an escaped fire.

ETA: Estimated Time of Arrival.

ETD: Estimated Time of Departure.

EXIT: A command used to indicate the direction for a pilot to fly after a given maneuver: i.e., "Exit southbound over the lake."

EXPOSURE: Property that may be endangered by a fire burning in another structure or by a wildfire. In general, property within 40 feet (12 meters) of a fire may be considered to involve exposure hazard, although, in very large fires, danger may exist at much greater distances.

EXTEND: To drop retardant in such a way that the load slightly overlaps and lengthens a previous drop. "Extend your last drop."

FAA: Federal Aviation Agency.

FAR (Federal Aviation Regulations): Refers to the regulations governing all aviation activities of civil aircraft within the United States and its territories.

FINAL: An air tanker is said to be "on final" when it is on line with the target and intends to make the drop on that pass. Applies also to cargo dropping.

FINE FUELS: Fast-drying dead fuels, generally characterized by a comparatively high surface area-to-volume ratio, which are less than 1/4-inch in diameter and have a timelag of one hour or less. These fuels (grass, leaves, needles, etc.) ignite readily and are consumed rapidly by fire when dry.

FIRE FOAM: An extinguishing agent, chemically and/or mechanically produced, that blankets and adheres to the fuel, reducing combustion. It relies on moisture it contains for its effectiveness, so is a short-term suppressant.

FIRE RETARDANT: Any substance except plain water that by chemical or physical action reduces the flammability of fuels or slows their rate of combustion, e.g., a liquid or slurry applied aerially or from the ground during a fire suppression operation.

FIRE SHELTER: A personal protection item carried by firefighters which forms a tent-like shelter of heat-reflective material.

FIRE WHIRL: A spinning, vortex column of ascending hot air and gases rising from a fire and carrying aloft smoke, debris, and flame. Fire whirls range from a foot or two in diameter to small tornadoes in size and intensity. They may involve the entire fire area or only a hot spot within the area.

FIREBREAK: Any natural or constructed discontinuity in a fuelbed utilized to segregate, stop, and control the spread of fire or to provide a control line from which to suppress a fire.

FIRELINE EXPLOSIVES (FLE): Specially developed coils containing explosive powder that are detonated to create a fireline through ground fuels.

FIRELINE: A loose term for any cleared strip used in control of a fire. That portion of a control line from which flammable materials have been removed by scraping or digging down to the mineral soil.

FIXED TANK: A device mounted inside or directly underneath an aircraft which can contain water or retardant for dropping onto a fire.

FLANK FIRE: A firing technique consisting of treating an area with lines of fire set into the wind which burn outward at right angles to the wind.

FLANKING FIRE SUPPRESSION: Working along the flanks, whether simultaneously or successively, from a less active or anchor point toward the head of a fire in order to contain the latter.

FLANKS OF A FIRE: The parts of a fire's perimeter that are roughly parallel to the main direction of spread.

FLAREUP: Any sudden acceleration of fire spread or intensification of the fire. Unlike *Blowup*, a flareup is of relatively short duration and does not radically change existing control plans.

FLASHOVER: In structural fire terminology, flashover occurs when radiation and convection from burning objects within an enclosure heat the walls and other objects in the enclosure to their ignition temperature and all flammable interior surfaces begin to flame. Flashover in a room is marked by a large increase in flame volume and a sudden, marked rise in gas temperature.

FLIR (Forward Looking Infrared): A hand-held or aircraft-mounted device designed to detect heat differentials and display their images on a video screen. FLIRs have thermal resolution similar to IR line scanners, but their spatial resolution is substantially less. They are commonly used to detect hot spots and flareups obscured by smoke to evaluate the effectiveness of firing operations, to detect areas needing mopup work, and for other purposes.

FOAM: See fire foam.

FOAMING AGENT: An additive that reduces the surface tension of water (producing wet water) causing it to spread and penetrate more effectively and which produces foam through mechanical means.

FUEL MODEL: A simulated fuel complex for which all the fuel descriptors required for the solution of a mathematical fire spread model have been specified.

FUEL MOISTURE CONTENT: The water content of a fuel particle expressed as a percent of the oven-dry weight of the fuel particle.

GROUND FIRE: Fire that consumes the organic material in the soil layer (e.g., a "peat fire").

GROUND FUELS: All combustible materials below the surface litter, including duff, tree or shrub roots, punky wood, peat, and sawdust that normally support a glowing combustion without flame.

HEAD FIRE: A fire spreading or set to spread with the wind and/or upslope.

HEADING: The compass direction in which the longitudinal axis of the aircraft points.

HELD LINE: All worked control lines that still contain the fire when mopup is completed.

HELIBUCKET: A specially designed bucket carried by a helicopter like a sling load and used to drop suppressants or retardants.

HELITACK: Fire suppression using helicopters and trained airborne teams to achieve control of wildfire.

HELITANK: A specially designed tank, generally of fabric or metal, fitted closely to the bottom of a helicopter and used for transporting and dropping suppressants or retardants.

HELITANKER: A helicopter equipped with either a helitank or a helibucket.

HELITORCH: An ignition device suspended under a helicopter, capable of dispensing ignited fuel to the ground to assist in burning out or backfiring.

HOT SPOT: A particularly active part of the fire.

HOTSPOTTING: Checking the spread of fire at points of particularly rapid spread or special threat—generally the initial step in prompt control, with emphasis on first priorities.

INDIRECT ATTACK: A method of suppression in which the control line is located some considerable distance away from the fire's active edge. Generally done in the case of a fast-spreading or high-intensity fire and to utilize natural or constructed firebreaks or fuelbreaks and favorable breaks in the topography. The intervening fuel is usually backfired; but occasionally the main fire is allowed to burn to the line, depending on conditions.

JUMP SPOT: A selected landing area for smokejumpers or helijumpers.

LEAD PLANE: Aircraft flown to make trial runs over the fire and used to direct the tactical deployment of air tankers.

LITTER: The top layer of the forest floor, composed of loose debris of dead sticks, branches, twigs, and recently fallen leaves or needles, little altered in structure by decomposition. See Duff.

LONG-TERM RETARDANT: A chemical that has the capability to inhibit spread of flame through chemical reactions between products of combustion and the applied chemicals, even after the water component has evaporated.

MAFFS (Modular Airborne Firefighting System): A manufactured unit consisting of five interconnecting tanks, a control pallet, and a nozzle pallet, with a capacity of 3,000 gallons (1 1,355 liters), designed to be rapidly mounted inside an unmodified C-130 (Hercules) cargo aircraft for use in cascading retardant chemicals on wildfires.

MODIFIED SUPPRESSION: Suppression action dictated by one or more management constraints that affect strategy and/or tactics.

MOPUP: The act of making a fire safe after it is controlled.

NATURAL BARRIER: A naturally occurring obstruction to the spread of fire.

ORBIT: The circular holding pattern of an air tanker in the vicinity of a fire waiting for orders to make a drop.

PARACARGO: Anything intentionally dropped or intended for dropping from any aircraft by parachute, other retarding devices, or free fall.

PARTS OF A FIRE: On typical free-burning fires, the spread is uneven with the main spread moving with the wind or upslope. The most rapidly moving portion is designated the *head* of the fire, the adjoining portions of the perimeter at right angles to the head are known as the *flanks*, and the slowest moving portion is known as the *rear* or the *base* or [Australia] the *back*.

PATROL: To go back and forth vigilantly over a length of control line during and/or after construction to prevent slopovers, control spot fires, and extinguish overlooked hot spots.

PING-PONG BALL DISPENSER (Premo MK III Aerial Ignition Device): An aerial ignition device which injects ethylene glycol into a plastic sphere containing potassium permanganate. The primed sphere is ejected from the aircraft.

PLOW LINE: Line constructed by a fireline plow.

PRE-TREAT: Treating fuels with retardant or foam along a control line in advance of the fire where ground cover or terrain is best for control action.

PROGRESSIVE HOSE LAY: A hose lay in which double shutoff wyes are inserted in the main line at intervals and lateral lines are run from the wyes to the fire edge, thus permitting continuous application of water during extension of the lay.

RAPPELLING: The process of delivering firefighters by descending down a rope from a hovering helicopter.

RATE OF SPREAD: The relative activity of a fire in extending its horizontal dimensions. The forward rate of spread at the fire front or head is usually what is meant by this term.

REBURN: (1) Repeat burning of an area over which a fire has previously passed but has left fuel subsequently ignitable. (2) Also the area so reburned.

REHABILITATION: The activities necessary to repair damage or disturbance caused by wildfire or the wildfire suppression activity.

RESIDENCE TIME: The time required for the flaming zone of a fire to pass a stationary point; the width of the flaming zone divided by the rate of spread of the fire.

RESTRICTED AREA: Airspace of defined dimensions identified by an area on the surface of the earth within which the flight of aircraft, while not wholly prohibited, is subject to restrictions.

RETARDANT COVERAGE: The area of fuel covered and degree of coverage on the fuel by a retardant. Coverage levels are usually expressed in terms of gallons per hundred square feet or liters per square meter.

RETARDANT: See fire retardant.

SAFETY ZONE: An area (usually a recently burned area) used for escape in the event the line is outflanked or in case a spot fire causes fuels outside the control line to render the line unsafe. In firing operations, crews progress so as to maintain a safety island close at hand allowing the fuels inside the control line to be consumed before going ahead. Safety islands may also be constructed as integral parts of fuelbreaks; they are greatly enlarged areas which can be used with relative safety by firefighters and their equipment in the event of blowup in the vicinity "without utilization or deployment of a fire shelter."

SCRATCH LINE: A minimum line hastily established or constructed as an initial measure to check the spread of a fire.

SECONDARY LINE: Any fireline constructed at a distance from the fire perimeter concurrently with or after a primary control line has already been constructed on or near to the perimeter of the fire. Generally constructed as an insurance measure in case the fire escapes control by the primary line.

SHORT-TERM RETARDANT: A chemical which has no inherent fire retarding property but which alters the viscosity or retards the evaporation of water.

SIMPLE HOSE LAY: A hose lay consisting of consecutively coupled lengths of hose without laterals. The lay is extended by inserting additional lengths of hose in the line between pump and nozzle.

SLING LOAD: Equipment and supplies prepared and transported by cables suspended from a helicopter.

SLOPOVER: A fire edge that crosses a control line intended to confine the fire. Also the fire that results. Other names are breakaway, breakover, and breakover fire.

SMOLDERING FIRE: A fire burning without flame and barely spreading.

SNAG: A standing dead tree or part of a dead tree from which at least the leaves and smaller branches have fallen. Often called stub, if less than 20 feet tall.

SPAN OF CONTROL: The maximum number of subordinates who can be directly supervised by one person without loss of efficiency. In fire suppression, the number varies by activity but is usually in the general range of 3 to 7.

SPOT FIRE: A fire set outside the perimeter of the main fire by flying sparks or embers.

SPOTTING: Behavior of a fire producing sparks or embers that start new fires beyond the zone of direct ignition by the main fire.

STRATEGY: An overall plan of action for fighting a fire which gives regard to the most cost-efficient use of personnel and equipment in consideration of values threatened, fire behavior, legal constraints, and objectives established for resource management. Leaves decisions on the tactical use of personnel and equipment to supervisors and leaders in the operations section.

STRIP FIRING: Setting fire to more than one strip of fuel and providing for the strips to burn together. Frequently done in burning out against the wind where inner strips are fired first to create drafts which pull flames and sparks away from the control line.

SURFACE FIRE: Fire that burns surface litter, other loose debris of the forest floor, and small vegetation.

SURFACE FUEL: Fuels that contact the surface of the ground, consisting of leaf and needle litter, dead branch material, downed logs, bark, tree cones, and low stature living plants.

SWAMPER: A worker on a dozer crew who pulls winch line, helps maintain equipment, etc., to speed suppression work on a fire. Sometimes used to walk ahead of the dozer to guide operator in construction of a fireline.

TACTICS: Operational aspects of fire suppression. Determining exactly where and how to build a control line and what other suppression measures are necessary to extinguish the fire. Tactics must be consistent with the strategy established for suppressing the fire.

TEST FIRE: A controlled fire set to evaluate fire behavior and control measures.

TIE-IN: To connect a control line or airdrop with another line coming from the opposite direction or with a specified point (road, stream, etc.). "Tie-in tanker 78's drop with the road."

TORCHING: The burning of the foliage of a single tree, or a small group of trees, from the bottom up.

TURN-THE-CORNER: To contain a fire along a flank and begin containing it across the head. Refers to ground or air attack.

UNDERCUT LINE: A fireline below a fire on a slope. Should be trenched to catch rolling material. Also called underslung line.

VALUES-AT-RISK: Physical and non-physical elements of the environment that may be adversely affected by fire.

VENTILATION: Air flow and supply through a structure.

VISCOSITY: The thickness of a solution or suspension. A measure of the relative capability of a fluid to resist flow. Heavy syrup has a high viscosity; gasoline has a low viscosity.

WET WATER: Water containing a wetting or foaming agent.

WETTING AGENT: An additive that reduces the surface tension of water (producing wet water) causing it to spread and penetrate more effectively.

WILDLAND-URBAN INTERFACE: That line, area, or zone where structures and other human development meets or intermingles with undeveloped wildland or vegetative fuels.

WING SPAN: The distance from wing tip to wing tip on a fixed-wing aircraft. Used for corrections left or right to a target location.